

PILOT'S OPERATING HANDBOOK AND FAA APPROVED AIRPLANE FLIGHT MANUAL



M20V

ACCLAIM
ULTRA

ORIGINAL ISSUE - 03-16-2017
Revision A - 08-18-2017

P/N: POH-003920

Copyright 2017 - All Rights Reserved

MOONEY INTERNATIONAL CORPORATION 165 Al Mooney Road, Kerrville, Texas 78028 tel: 830-896-6000
www.mooney.com



CAUTION

**THIS AIRCRAFT IS CERTIFIED
TO USE 100LL (BLUE) OR
100/130 (GREEN) AVIATION
GASOLINE ONLY. IT IS THE
PILOT'S RESPONSIBILITY TO
INSURE THAT THE PROPER
FUEL IS USED AT EACH
REFUELING.**



**PILOT'S OPERATING HANDBOOK
AND
FAA APPROVED
AIRPLANE FLIGHT MANUAL
MOONEY
MODEL M20V ACCLAIM ULTRA**

THIS HANDBOOK INCLUDES THE MATERIAL REQUIRED TO BE FURNISHED TO THE PILOT BY THE FEDERAL AVIATION REGULATIONS, AND CONSTITUTES THE FAA APPROVED AIRPLANE FLIGHT MANUAL.

THIS DOCUMENT MUST BE CARRIED IN THE AIRCRAFT AT ALL TIMES.

**MOONEY INTERNATIONAL CORPORATION
165 AL MOONEY ROAD
KERRVILLE, TEXAS 78028**

SERIAL NUMBER: _____

REGISTRATION NUMBER: _____

FAA APPROVED: _____

Jim Grigg
Manager, Aircraft Certification Office
FEDERAL AVIATION ADMINISTRATION
10101 Hillwood Parkway
Fort Worth, Texas 76177

DATE: **03-16-2017** _____

FAA APPROVED in Normal Category based on CAR PART 3, applicable portions of FAR PART 23, and when applicable components are installed in accordance with Mooney Drawing 110101; applicable to Model M20V S/N listed above only.

This handbook meets GAMA Specification No. 1, SPECIFICATION FOR PILOT'S OPERATING HANDBOOK, issued February 15, 1975, revised October 18, 1996; Revision No. 2.

Copyright© 2017 All Rights Reserved Mooney International Corporation - 165 Al Mooney Rd - Kerrville, Texas 78028

ORIGINAL ISSUE - 03-16-2017
Revision A: 08-18-2017



POH/AFM NUMBER: POH-003920

BLANK



CONGRATULATIONS

WELCOME TO MOONEY'S NEWEST DIMENSION IN SPEED, QUALITY AND ECONOMY. YOUR DECISION TO SELECT A MOONEY AIRCRAFT HAS PLACED YOU IN AN ELITE AND DISTINCTIVE CLASS OF AIRCRAFT OWNERS. WE HOPE YOU FIND YOUR MOONEY A UNIQUE FLYING EXPERIENCE, WHETHER FOR BUSINESS OR PLEASURE, THE MOST PROFITABLE EVER.

- NOTICE -

This manual is provided as an operating guide for the Mooney Model M20V. It is important that you, regardless of your previous experience, carefully read the handbook from cover to cover and review it frequently. THIS AFM MUST BE CARRIED IN THE AIRCRAFT AT ALL TIMES.

All information and illustrations in the manual are based on the latest product information available at the time of publication approval and all sections including attached supplements are mandatory for proper operation of the aircraft. The right is reserved to make changes at anytime without notice. Every effort has been made to present the material in a clear and convenient manner to enable you to use the manual as a reference. Your cooperation in reporting presentation and content recommendations is solicited.

REVISING THE MANUAL

The "i" pages of this manual contain a "List of Effective Pages" containing a complete current listing of all pages i.e., Original or Revised. Also, in the lower right corner of the outlined portion, is a box which denotes the manual number and issue or revision of the manual. It will be advanced one letter, alphabetically, per revision. With each revision to the manual a new List of Effective Pages showing all applicable revisions with dates of approval and a "Log of Revisions" page(s), with only the latest Revision shown, will be provided to replace the previous ones. It is the operators responsibility to ensure that this manual is current through the latest published revision. This handbook will be kept current by Mooney International Corporation, paper copies can be purchased through an authorized Mooney Service Center or through the Factory Parts Department. Electronic downloads, Log of Revisions and Supplements are available at Mooney Internationals website at www.mooney.com

Service Parts Department
Mooney International Corporation
165 Al Mooney Road
Kerrville, TX. 78028

Email: serviceparts@mooney.com, techpubs@mooney.com or support@mooney.com



BLANK



LIST OF EFFECTIVE PAGES

ORIGINAL ISSUE 03-16-2017
■ Revision A 08-18-2017

Always destroy superseded pages when inserting revised pages.

■ TITLE PAGE 08-18-2017
CONGRATULATIONS ORIGINAL ISSUE
i 08-18-2017
ii 08-18-2017
iii 08-18-2017
iv ORIGINAL ISSUE
v ORIGINAL ISSUE
vi ORIGINAL ISSUE
■ vii 08-18-2017
viii ORIGINAL ISSUE
ix ORIGINAL ISSUE
x ORIGINAL ISSUE
■ 1-1 08-18-2017
1-2 ORIGINAL ISSUE
1-3 ORIGINAL ISSUE
1-4 ORIGINAL ISSUE
1-5 ORIGINAL ISSUE
■ 1-6 08-18-2017
1-7 ORIGINAL ISSUE
1-8 ORIGINAL ISSUE
1-9 ORIGINAL ISSUE
1-10 ORIGINAL ISSUE
1-11 ORIGINAL ISSUE
1-12 ORIGINAL ISSUE
1-13 ORIGINAL ISSUE
1-14 ORIGINAL ISSUE
■ 2-1 08-18-2017
2-2 ORIGINAL ISSUE
2-3 ORIGINAL ISSUE
2-4 ORIGINAL ISSUE
2-5 ORIGINAL ISSUE
2-6 ORIGINAL ISSUE
2-7 ORIGINAL ISSUE
2-8 ORIGINAL ISSUE
2-9 ORIGINAL ISSUE
2-10 ORIGINAL ISSUE
■ 2-11 08-18-2017
2-12 ORIGINAL ISSUE
2-13 ORIGINAL ISSUE
2-14 ORIGINAL ISSUE
2-15 ORIGINAL ISSUE
2-16 ORIGINAL ISSUE
2-17 ORIGINAL ISSUE
2-18 ORIGINAL ISSUE
2-19 ORIGINAL ISSUE
2-20 ORIGINAL ISSUE
2-21 ORIGINAL ISSUE
2-22 ORIGINAL ISSUE
■ 3-1 08-18-2017
3-2 08-18-2017



3-3	ORIGINAL ISSUE
3-4	08-18-2017
3-5	08-18-2017
3-6	08-18-2017
3-7	08-18-2017
3-8	08-18-2017
3-9	08-18-2017
3-10	08-18-2017
3-11	08-18-2017
3-12	08-18-2017
3-13	08-18-2017
3-14	08-18-2017
3-15	08-18-2017
3-16	08-18-2017
3-17	08-18-2017
3-18	08-18-2017
3-19	08-18-2017
3-20	08-18-2017
3-21	08-18-2017
3-22	08-18-2017
3-23	08-18-2017
3-24	08-18-2017
3-25	08-18-2017
3-26	08-18-2017
3-27	08-18-2017
3-28	08-18-2017
3-29	08-18-2017
3-30	08-18-2017
4-1	ORIGINAL ISSUE
4-2	ORIGINAL ISSUE
4-3	ORIGINAL ISSUE
4-4	ORIGINAL ISSUE
4-5	ORIGINAL ISSUE
4-6	08-18-2017
4-7	ORIGINAL ISSUE
4-8	ORIGINAL ISSUE
4-9	ORIGINAL ISSUE
4-10	ORIGINAL ISSUE
4-11	ORIGINAL ISSUE
4-12	ORIGINAL ISSUE
4-13	ORIGINAL ISSUE
4-14	ORIGINAL ISSUE
4-15	ORIGINAL ISSUE
4-16	ORIGINAL ISSUE
4-17	ORIGINAL ISSUE
4-18	ORIGINAL ISSUE
5-1	ORIGINAL ISSUE
5-2	ORIGINAL ISSUE
5-3	ORIGINAL ISSUE
5-4	ORIGINAL ISSUE
5-5	ORIGINAL ISSUE
5-6	ORIGINAL ISSUE
5-7	ORIGINAL ISSUE
5-8	ORIGINAL ISSUE
5-9	ORIGINAL ISSUE
5-10	ORIGINAL ISSUE



5- 11	ORIGINAL ISSUE
5- 12	ORIGINAL ISSUE
5- 13	ORIGINAL ISSUE
5- 14	ORIGINAL ISSUE
5- 15	ORIGINAL ISSUE
5- 16	ORIGINAL ISSUE
5- 17	ORIGINAL ISSUE
5- 18	ORIGINAL ISSUE
5- 19	ORIGINAL ISSUE
5- 20	ORIGINAL ISSUE
5- 21	ORIGINAL ISSUE
5- 22	ORIGINAL ISSUE
5- 23	ORIGINAL ISSUE
5- 24	ORIGINAL ISSUE
5- 25	ORIGINAL ISSUE
5- 26	ORIGINAL ISSUE
5- 27	ORIGINAL ISSUE
5- 28	ORIGINAL ISSUE
5- 29	ORIGINAL ISSUE
5- 30	ORIGINAL ISSUE
5- 31	ORIGINAL ISSUE
5- 32	ORIGINAL ISSUE
5- 33	ORIGINAL ISSUE
5- 34	ORIGINAL ISSUE
5- 35	ORIGINAL ISSUE
5- 36	ORIGINAL ISSUE
5- 37	ORIGINAL ISSUE
5- 38	ORIGINAL ISSUE
5- 39	ORIGINAL ISSUE
5- 40	ORIGINAL ISSUE
5- 41	ORIGINAL ISSUE
5- 42	ORIGINAL ISSUE
5- 43	ORIGINAL ISSUE
5- 44	ORIGINAL ISSUE
5- 45	ORIGINAL ISSUE
5- 46	ORIGINAL ISSUE
5- 47	ORIGINAL ISSUE
5- 48	ORIGINAL ISSUE
5- 49	ORIGINAL ISSUE
5- 50	ORIGINAL ISSUE
5- 51	ORIGINAL ISSUE
5- 52	ORIGINAL ISSUE
5- 53	ORIGINAL ISSUE
5- 54	ORIGINAL ISSUE
5- 55	ORIGINAL ISSUE
5- 56	ORIGINAL ISSUE
5- 57	ORIGINAL ISSUE
5- 58	ORIGINAL ISSUE
5- 59	ORIGINAL ISSUE
5- 60	ORIGINAL ISSUE
5- 61	ORIGINAL ISSUE
5- 62	ORIGINAL ISSUE
5- 63	ORIGINAL ISSUE
5- 64	ORIGINAL ISSUE
5- 65	ORIGINAL ISSUE
5- 66	ORIGINAL ISSUE



5- 67	ORIGINAL ISSUE
5- 68	ORIGINAL ISSUE
5- 69	ORIGINAL ISSUE
5- 70	ORIGINAL ISSUE
5- 71	ORIGINAL ISSUE
5- 72	ORIGINAL ISSUE
6- 1	08-18-2017
6- 2	ORIGINAL ISSUE
6- 3	ORIGINAL ISSUE
6- 4	ORIGINAL ISSUE
6- 5	ORIGINAL ISSUE
6- 6	ORIGINAL ISSUE
6- 7	ORIGINAL ISSUE
6- 8	ORIGINAL ISSUE
6- 9	ORIGINAL ISSUE
6-10	ORIGINAL ISSUE
6-11	ORIGINAL ISSUE
6-12	ORIGINAL ISSUE
6-13	ORIGINAL ISSUE
6-14	ORIGINAL ISSUE
6-15	ORIGINAL ISSUE
6-16	ORIGINAL ISSUE
6-17	ORIGINAL ISSUE
6-18	ORIGINAL ISSUE
6-19	ORIGINAL ISSUE
6-20	ORIGINAL ISSUE
6-21	ORIGINAL ISSUE
6-22	ORIGINAL ISSUE
6-23	ORIGINAL ISSUE
6-24	08-18-2017
6-25	ORIGINAL ISSUE
6-26	ORIGINAL ISSUE
6-27	ORIGINAL ISSUE
6-28	ORIGINAL ISSUE
6-29	08-18-2017
6-30	ORIGINAL ISSUE
7- 1	08-18-2017
7- 2	08-18-2017
7- 3	ORIGINAL ISSUE
7- 4	ORIGINAL ISSUE
7- 5	ORIGINAL ISSUE
7- 6	08-18-2017
7- 7	ORIGINAL ISSUE
7- 8	ORIGINAL ISSUE
7- 9	ORIGINAL ISSUE
7-10	ORIGINAL ISSUE
7-11	ORIGINAL ISSUE
7-12	ORIGINAL ISSUE
7-13	08-18-2017
7-14	08-18-2017
7-15	08-18-2017
7-16	ORIGINAL ISSUE
7-17	ORIGINAL ISSUE
7-18	ORIGINAL ISSUE
7-19	ORIGINAL ISSUE
7-20	ORIGINAL ISSUE





7- 21	ORIGINAL ISSUE
7- 22	ORIGINAL ISSUE
7- 23	ORIGINAL ISSUE
7- 24	ORIGINAL ISSUE
7- 25	ORIGINAL ISSUE
7- 26	ORIGINAL ISSUE
7- 27	ORIGINAL ISSUE
7- 28	ORIGINAL ISSUE
7- 29	08-18-2017
7- 30	ORIGINAL ISSUE
7- 31	ORIGINAL ISSUE
7- 32	ORIGINAL ISSUE
7- 33	ORIGINAL ISSUE
7- 34	ORIGINAL ISSUE
7- 35	ORIGINAL ISSUE
7- 36	ORIGINAL ISSUE
8- 1	ORIGINAL ISSUE
8- 2	ORIGINAL ISSUE
8- 3	ORIGINAL ISSUE
8- 4	ORIGINAL ISSUE
8- 5	ORIGINAL ISSUE
8- 6	ORIGINAL ISSUE
8- 7	ORIGINAL ISSUE
8- 8	ORIGINAL ISSUE
8- 9	ORIGINAL ISSUE
8-10	ORIGINAL ISSUE
9- 1	ORIGINAL ISSUE
9- 2	ORIGINAL ISSUE
9- 3	ORIGINAL ISSUE
9- 4	ORIGINAL ISSUE
(Plus applicable supplements inserted)	
10- 1	ORIGINAL ISSUE
10- 2	ORIGINAL ISSUE
10- 3	ORIGINAL ISSUE
10- 4	ORIGINAL ISSUE
10- 5	ORIGINAL ISSUE
10- 6	ORIGINAL ISSUE
10- 7	ORIGINAL ISSUE
10- 8	ORIGINAL ISSUE
10- 9	ORIGINAL ISSUE
10-10	ORIGINAL ISSUE
10-11	ORIGINAL ISSUE
10-12	ORIGINAL ISSUE



BLANK

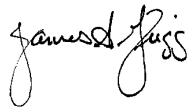

LOG OF REVISIONS

REVISION LETTER	REVISED PAGES	FAA APPROVED	DATE
ORIGINAL ISSUE	ALL		3-16-2017
Revision A	See Narrative Discussion of Revisions Page viii		08-18-2017



NARRATIVE DISCUSSION OF REVISIONS

Rev Level	Page Number	Comment
OI	ALL	Original Issue: Release of M20V Acclaim Ultra
A	Title page	Corrected spelling of “Registration”
A	Title page, i, ii, iii, vii, viii	Revised page numbers of effected pages
A	1-6	Removed “Hartzell” from Governor line
A	1-1, 2-1, 3-1, 3-2, 6-1, 7-1, 7-2	Revised Table of Contents
A	2-11	Revised Garmin Cockpit Reference Guide part number
A	3-4	Added “LOW MAN PRESS” Annunciation
A	3-5	Revised “ACTION WHEN ON” spelled out names
A	3-6 thru 3-11, 7-13	Revised and Added Alert/ Annunciation Images
A	3-5 thru 3-30	Page numbering has changed due to new information
A	3-25, 7-6	Deleted: SKYWATCH - Added: New Optional equipment
A	4-6	Revised Oxygen Chart to: “See POH/AFM Supplement”
A	4-6	Revised word annunciator to annunciation
A	6-24, 6-29	Revised Weight and Balance Data to match Eng Drwg
A	7-6	Revised Garmin Cockpit Reference Guide part number
A	7-14	Revised Alert/ Annunciation to match wording of NXi
A	7-15	Revised “60 ± 5 KTS” to “70 ± 5 KTS”
A	7-29	Revised diagram to show Generic components (NXi)



TABLE OF CONTENTS

TITLE	SECTION
GENERAL	I
LIMITATIONS	II
EMERGENCY PROCEDURES	III
NORMAL PROCEDURES	IV
PERFORMANCE	V
WEIGHT & BALANCE	VI
AIRPLANE & SYSTEM DESCRIPTIONS	VII
HANDLING, SERVICE & MAINTENANCE	VIII
SUPPLEMENTAL DATA	IX
SAFETY & OPERATIONAL TIPS	X



BLANK



TABLE OF CONTENTS

TITLE	SECTION
THREE VIEW	1-3
INTRODUCTION	1-4
DESCRIPTIVE DATA	1-5
ENGINE	1-5
PROPELLER	1-6
FUEL	1-6
OIL	1-6
LANDING GEAR	1-7
MAXIMUM CERTIFICATED WEIGHTS	1-7
STANDARD AIRPLANE WEIGHTS	1-7
CABIN & ENTRY DIMENSIONS	1-7
BAGGAGE SPACE & ENTRY DIMENSIONS	1-7
SPECIFIC LOADINGS	1-7
IDENTIFICATION PLATE	1-8
OXYGEN SYSTEM	1-8
GARMIN G1000	1-8
SYMBOLS, ABBREVIATIONS & TERMINOLOGY	1-9
GENERAL AIRSPEED TERMINOLOGY & SYMBOLS	1-9
ENGINE POWER TERMINOLOGY	1-9
AIRPLANE PERFORMANCE & FLIGHT PLANNING TERMINOLOGY	1-10
ENGINE CONTROLS & INSTRUMENTS TERMINOLOGY	1-10
METEOROLOGICAL TERMINOLOGY	1-10
WEIGHT & BALANCE TERMINOLOGY	1-11
MEASUREMENT CONVERSION TABLES	1-12
USE OF THE TERMS <i>WARNING</i> , <i>CAUTION</i> AND <i>NOTE</i>	1-14



BLANK



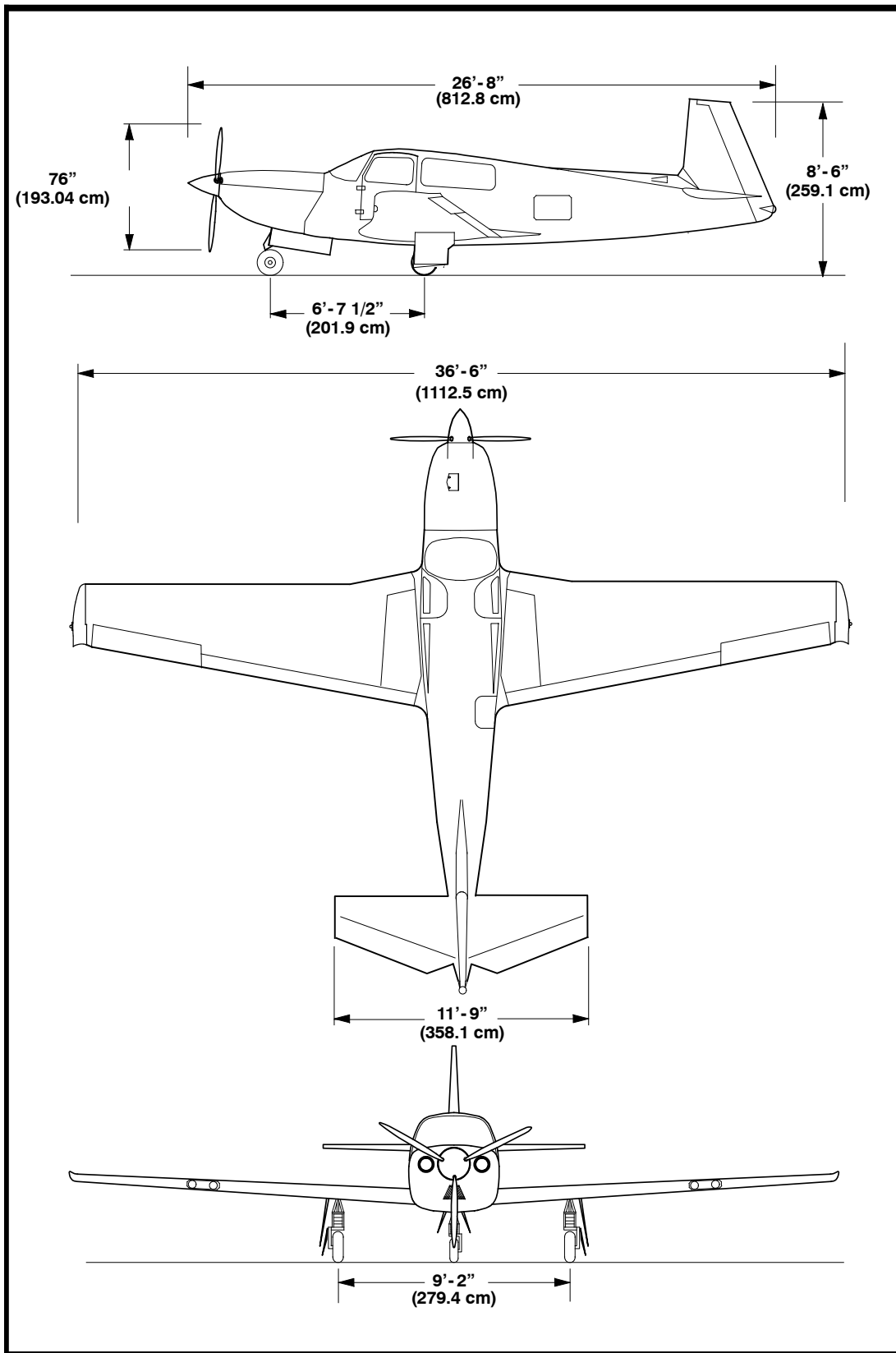

FIGURE 1-1 THREE VIEW



INTRODUCTION

This Operators Manual conforms to GAMA Specification No. 1 and includes both Manufacturer's material and FAA APPROVED material required to be furnished to the pilot by the applicable Federal Aviation Regulations. Section IX contains supplemental data supplied by Mooney International Corporation.

Section I contains information of general interest to the pilot. It also contains definitions of the terminology used in this Operators Manual.

This Pilot's Operating Handbook is not designed as a substitute for adequate and competent flight instruction, knowledge of current airworthiness directives, applicable federal air regulations or advisory circulars. It is not intended to be a guide for basic flight instruction or a training manual and should not be used for operational purposes unless kept in an up-to-date status.

All limitations, procedures, safety practices, servicing and maintenance requirements published in this POH/AFM are considered mandatory for the Continued Airworthiness of this airplane in a condition equal to that of its original manufacture.

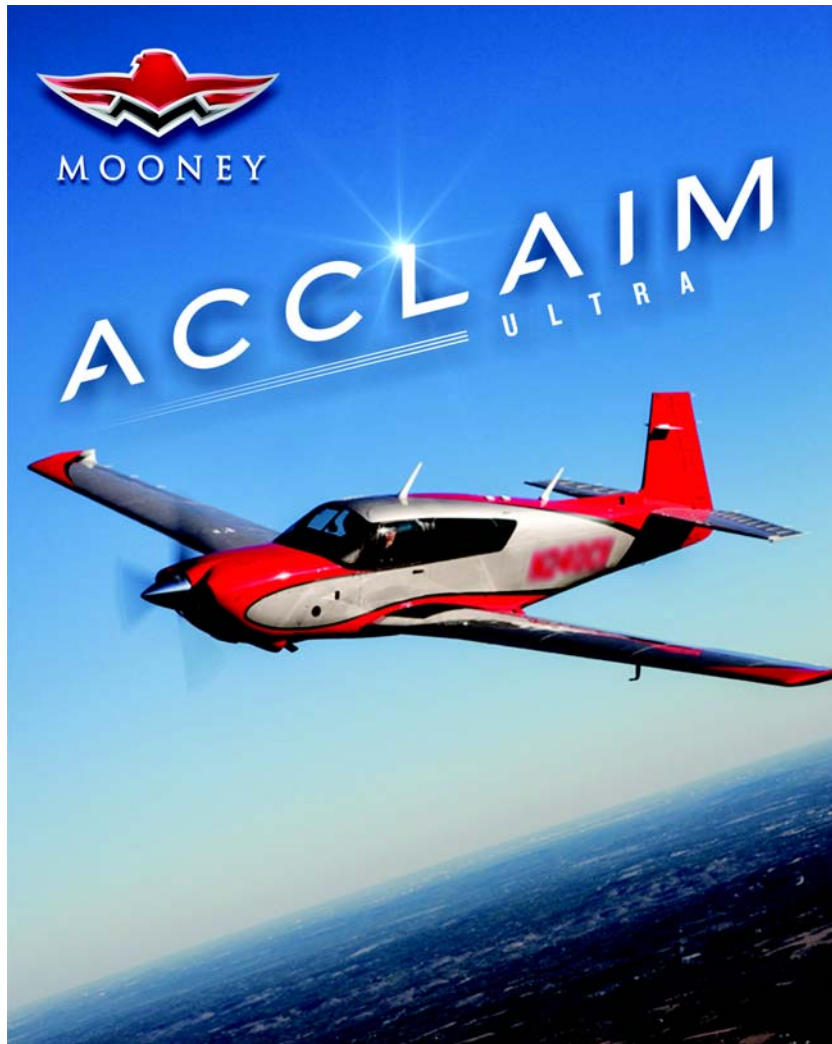

DESCRIPTIVE DATA

ENGINE

Number of Engines 1
Engine Manufacturer Continental Motors, Inc.
Engine Model Number (S/N 33- 0001 and ON) TSIO- 550- G (5)
Recommended TBO 2200 Hours
Type Reciprocating, air cooled, fuel injected, Turbo-Normalized
Number of Cylinders 6, Horizontally opposed
Firing Order 1-6-3-2-5-4
Displacement 552 Cu. In. (9.05 Liters)
Bore 5.25 In. (13.3 cm)
Stroke 4.25 In. (10.8 cm)
Compression Ratio 7.5:1

FUEL SYSTEM:

Type Fuel Injection
Make Continental Motors, Inc.
Fuel - Aviation Gasoline 100 octane - 100LL

ACCESSORIES:

Magnetos Bendix S6RSC- 25P (pressurized)
Ignition Harness Shielded/Braided
Spark Plugs AC 273 (or equivalent) (18 m/m)
Oil Cooler Continental Motors, Inc. Full Flow
Alternator 28 Volt DC, 100 AMPS
Starter 24 volt DC
Intercooler Continental Motors, Inc.
Turbocharger Continental Motors, Inc./Kelly Aerospace Model TA36
Turbocharger Controller System Continental Motors, Inc.

RATINGS:

Maximum Continuous Power 280 BHP at 2500 RPM
Recommended Cruise Power 262 BHP at 2500 RPM



PROPELLER

Hartzell

Number	1
Manufacturer	Hartzell
Model Number	PHC- J3YF- 1RF/F7498
The (B) denotes a booted prop (for TKS)	PHC- J3YF- 1RF/F7498(B)
Number of Blades	3
Diameter (MAX.)	76 in. (193.0 cm)
(MIN.)	74 in. (188.0 cm)
Type	Constant Speed
■ Governor	Hydraulically controlled by engine oil
Blade Angles @ 30.0 in. Sta.:	
Low	17.0 degrees +/- 0.2 degrees
High	38.0 degrees +/- 1.0 degrees

FUEL

Minimum Fuel Grade (Color)	100 LL (Blue) or 100 Octane (Green)
Total Fuel - Useable	89 U.S. Gal. (336.9 liters)
Unusable Fuel	6 U.S. Gal. (22.7 liters)

OIL

Oil Specification or Oil Grade (First 25 Engine Hours) - Non dispersant mineral oil conforming to SAE J1966 shall be used during the first 25 hours of flight operations. However, if the engine is flown less than once a week, a straight mineral oil with corrosion preventative MIL- C- 6529 for the first 25 hours is recommended.

Oil Specification or Oil Grade (After 25 Engine Hours) - Continental Motors Specification MHS- 24. An ashless dispersant oil shall be used after 25 hours.

Oil Grades Recommended for Various Average Air Temperature Ranges

Below 40° F (4° C)	SAE 30, 10W30, 15W50 or 20W50
Above 40° F (4° C)	SAE 50, 15W50 or 20W50
Total Oil Capacity	8 Qts. (7.57 liters)
Oil Filter	Full Flow

Oil grades, specifications and changing recommendations are contained in [SECTION VIII](#).

-NOTE-

The first time the airplane is filled with oil, additional oil is required for the filter, oil cooler and propeller dome. This oil is not drainable on subsequent oil changes. Added oil is mixed with a few quarts of older oil in the system.



LANDING GEAR

TYPE: Electrically operated, fully retractable tricycle gear with rubber shock discs. The main wheels have hydraulically operated disc brakes. The nose wheel is fully steerable 11° left to 13° right of center.

Wheelbase 6'- 7 1/2" (201.9 cm)

Wheel Track 9'- 2" (279.4 cm)

Tire Size:

Nose 5.00 x 5 (6 ply)

Main 6.00 x 6 (6 ply)

Tire Pressure

Nose 49 PSI

Main 42 PSI

Minimum Turning Radius (No brakes applied)

Right 40 ft. (12.0 m)

Left 48 ft. (14.4 m)

MAXIMUM CERTIFICATED WEIGHTS

Gross Weight 3368 Lbs. (1528 Kg)

Maximum Landing Weight 3200 Lbs. (1452 Kg)

Useful Load (No Options) 1049 Lbs. (475.8 Kg)

Baggage Area 120 Lbs. (54.4 Kg)

Rear Storage Area 10 Lbs. (4.5 Kg)

Cargo (Rear Seats Folded Down) 340 Lbs. (154.2 Kg)

STANDARD AIRPLANE WEIGHTS

Basic Empty Weight See Page 1- 11

Useful Load Varies with installed equipment

See SECTION VI for specific airplane weight.

CABIN AND ENTRY DIMENSIONS

Cabin Width (Maximum) 43.5 In. (110.5 cm)

Cabin Length (Maximum) 126 In. (315 cm)

Cabin Height (Maximum) 44.5 In. (113 cm)

Entry Width (Minimum) 34.0 In. (86.36 cm)

Entry Height (Minimum) 32.5 In. (82.55 cm)

BAGGAGE SPACE AND ENTRY DIMENSIONS

Compartment Width 24 In. (60.9 cm)

Compartment Length 43 In. (109.2 cm)

Compartment Height 35 In. (88.9 cm)

Compartment Volume 22.6 cu. ft.

..... (0.63 cu. m)

Cargo Area (with rear seat folded down) 38.6 cu. ft.

..... (1.09 cu. m)

Entry Height (Minimum) 20.5 In. (52.1 cm)

Entry Width 17.0 In. (43.2 cm)

Ground to Bottom of Sill 46.0 In. (116.8 cm)

SPECIFIC LOADINGS

Wing Loading - @ Maximum Gross Weight 19.26 lbs./sq. ft.

..... (94 kg/sq. m)

Power Loading - @ Maximum Gross Weight 12.03 lbs./HP

..... (5.46 kg/HP)



IDENTIFICATION PLATE

All correspondence regarding your airplane should include the Serial Number as depicted on the identification plate. The identification plate is located on the left hand side, aft end of the tailcone, below the horizontal stabilizer leading edge. The aircraft Serial Number and type certificate are shown.

OXYGEN SYSTEM: (Refer to Supplemental Information [Section IX](#))

GARMIN G1000 GENERAL

The GARMIN G1000 Integrated Avionics System is a fully integrated flight, engine, communication, navigation and surveillance instrumentation system. The system consists of a Primary Flight Display (PFD), Multi-Function Display (MFD), audio panel (GMA), Air Data Computer (ADC), Attitude and Heading Reference System (AHRS), engine/airframe processing unit (GEA), and integrated avionics (GIA) containing VHF communications, VHF navigation, and GPS navigation.

-WARNING-

Do not load a new arrival or departure procedure in the flight plan if one currently exists without first removing the existing arrival or departure procedure. Failing to observe this limitation can cause erroneous course deviation indications, loss of GPS navigation information, and other display anomalies.

-NOTE-

If display anomalies are noted after editing the flight plan, perform either a direct to or activate leg operation as appropriate on the flight plan to ensure correct flight plan sequencing and guidance.

The primary function of the PFD is to provide attitude, heading, air data, navigation, and alerting information to the pilot. The PFD may also be used for flight planning. The primary function of the MFD is to provide engine information, mapping terrain information and for flight planning. The audio panel is used for selection of radios for transmitting and listening, intercom functions, and marker beacon functions.

The primary function of the VHF Communication portion of the G1000 is to enable external radio communication. The primary function of the VOR/ILS Receiver portion of the equipment is to receive and demodulate VOR, localizer, and Glide Slope signals. The primary function of the GPS portion of the system is to acquire signals from the GPS satellites, recover orbital data, make range and Doppler measurements, and process this information in real time to obtain the user's position, velocity, and time.

Provided the GARMIN G1000 GPS receivers are receiving adequate and usable GPS and/or VHF navigation signals, it has been demonstrated capable of and meets the accuracy specifications for the following types of flight operations:

VFR/IFR en- route, oceanic, and terminal operations as well as nonprecision instrument approach (GPS, Loran- C, VOR, VOR- DME, TACAN, NDB, NDB- DME, RNAV) operation within the U.S. National Airspace System in accordance with AC20- 138A.

Navigation in the North Atlantic Minimum Navigation Performance Specification (MNPS) Airspace in accordance with AC91- 49 and AC 120- 33.

The GARMIN G1000 system meets RNP5 airspace (BRNAV) requirements of AC 90- 96 and in accordance with AC 20- 138A, JAA AMJ 20X2 Leaflet 2 Revision 1, and FAA Order 8110.60 for oceanic and remote airspace operations, provided it is receiving usable navigation information from the GPS receiver. (A separate software application for prediction of GPS navigation availability may be required for oceanic and remote operations. Refer to appropriate limitations for the airspace you are operating in to determine if this GPS prediction software is required).

Navigation is accomplished using the WGS- 84 (NAD- 83) coordinate reference datum. GPS navigation data is based upon use of only the Global Positioning System (GPS) operated by the United States of America.



SYMBOLS, ABBREVIATIONS & TERMINOLOGY

GENERAL AIR SPEED TERMINOLOGY & SYMBOLS

GS	GROUND SPEED - Speed of an airplane relative to the ground.
KCAS	KNOTS CALIBRATED AIR SPEED - The indicated speed of an aircraft, corrected for position and instrument error. Calibrated airspeed is equal to true airspeed in standard atmosphere at sea level.
KIAS	KNOTS INDICATED AIRSPEED - The speed of an aircraft as shown on its airspeed indicator. IAS values published in this handbook assume zero instrument error.
KTAS	KNOTS TRUE AIRSPEED - The airspeed of an airplane relative to undisturbed air which is the KCAS corrected for altitude and temperature.
V _a	MANEUVERING SPEED - The maximum speed at which application of full available aerodynamic control will not overstress the airplane.
V _{fe}	MAXIMUM FLAP EXTENDED SPEED - The highest speed permissible with wing flaps in a prescribed extended position.
V _{le}	MAXIMUM LANDING GEAR EXTENDED SPEED - The maximum speed at which an aircraft can be safely flown with the landing gear extended.
V _{lo}	MAXIMUM LANDING GEAR OPERATING SPEED - The maximum speed at which the landing gear can be safely extended or retracted.
V _{ne}	NEVER EXCEED SPEED - The speed limit that may not be exceeded at any time.
V _{no}	MAXIMUM STRUCTURAL CRUISING SPEED - The speed that should not be exceeded except in smooth air and then only with caution.
V _s	STALLING SPEED - The minimum steady-flight speed at which the airplane is controllable.
V _{so}	STALLING SPEED - The minimum steady flight speed at which the airplane is controllable in the landing configuration.
V _x	BEST ANGLE- OF- CLIMB SPEED - The airspeed which delivers the greatest gain of altitude in the shortest possible horizontal distance.
V _y	BEST RATE- OF- CLIMB SPEED - The airspeed which delivers the greatest gain in altitude in the shortest possible time with gear and flaps up.

ENGINE POWER TERMINOLOGY

BHP	BRAKE HORSEPOWER - Power developed by the engine.
CHT	CYLINDER HEAD TEMPERATURE - Operating temperature of engine cylinder(s) being monitored by sensor unit. Expressed in °F.
TIT	TURBINE INLET TEMPERATURE - Temperature at turbine inlet used to identify the lean fuel flow mixtures for various power settings. Expressed in °F.
EGT	EXHAUST GAS TEMPERATURE - The exhaust gas temperature measured in the exhaust pipe manifold. Expressed in °F
MCP	MAXIMUM CONTINUOUS POWER - The maximum power for take off, normal emergency operations.
MP	MANIFOLD PRESSURE - Pressure measured in the engine's induction system and expressed in inches of mercury (Hg).
RPM	REVOLUTIONS PER MINUTE - Engine speed.



AIRPLANE PERFORMANCE AND FLIGHT PLANNING TERMINOLOGY

Demonstrated Crosswind Velocity	The velocity of the crosswind component for which adequate control of the airplane during take off and landing test was actually demonstrated during certification. The value shown is not considered to be limiting.
g	Acceleration due to gravity.
Service Ceiling	The maximum altitude at which aircraft at gross weight has the capability of climbing at the rate of 100 ft/min.

ENGINE CONTROLS & INSTRUMENTS TERMINOLOGY

Propeller Control	The control used to select engine speed.
Throttle Control	The control used to select engine power by controlling MP.
Mixture control	Provides a mechanical linkage to the fuel injector mixture control to control the size of the fuel feed aperture, and therefore the air/fuel mixture. It is the primary method to shut the engine down.
CHT Gauge	Cylinder head temperature indicator used to determine that engine operating temperature is within manufacturers specifications.
Tachometer	An instrument that indicates rotational speed of the engine. The speed is shown as propeller revolutions per minute (RPM).
Propeller Governor	The device that regulates RPM of the engine/propeller by increasing or decreasing the propeller pitch, through a pitch change mechanism in the propeller hub.

METEOROLOGICAL TERMINOLOGY

AGL	Above ground level.
Density Altitude	Altitude as determined by pressure altitude and existing ambient temperature. In standard atmosphere (ISA) density and pressure altitude are equal. For a given pressure altitude, the higher the temperature, the higher the density altitude.
Indicated Altitude	The altitude actually read from an altimeter when, and only when barometric subscale (Kollsman window) has been set to Station Pressure.
ISA	INTERNATIONAL STANDARD ATMOSPHERE assumes that 1. The air is a dry perfect gas; 2. The temperature at sea level is 15 degrees Celsius (59°F); 3. The pressure at sea level is 29.92 inches Hg (1013.2 MB); 4. The temperature gradient from sea level to the altitude at which the temperature is - 56.5°C (- 69.7°F) is - 0.00198°C (- 0.003564°F) per foot.
OAT	OUTSIDE AIR TEMPERATURE - The free air static temperature, obtained either from in- flight temperature indications or ground meteorological sources. It is expressed in °C.
Pressure Altitude	The indicated altitude when Kollsman window is set to 29.92 In. Hg. or 1013.2 MB. In this handbook, altimeter instrument errors are assumed to be zero.
Station Pressure	Actual atmospheric pressure at field elevation.



WEIGHT AND BALANCE TERMINOLOGY

Arm	The horizontal distance from the reference datum to the center of gravity (C.G.) of an item.
Basic Empty weight	The actual weight of the airplane and includes all operating equipment (including optional equipment) that has a fixed location and is actually installed in the aircraft. It includes the weight of unusable fuel and full oil.
Center of Gravity (C.G.)	The point at which an airplane would balance if suspended. Its distance from the reference datum is found by dividing the total moment by the total weight of the airplane.
C.G. Arm	The arm obtained by adding the airplane's individual moments and dividing the sum by the total weight.
C.G. in % MAC	Center of Gravity expressed in percent of mean aerodynamic chord (MAC).
C.G. Limits	The extreme center of gravity locations within which the airplane must be operated at a given weight.
MAC	Mean Aerodynamic Chord.
Maximum Weight	The maximum authorized weight of the aircraft and its contents as listed in the aircraft specifications.
Maximum Landing Weight	The maximum authorized weight of the aircraft and its contents when a normal landing is to be made.
Moment	The product of the weight of an item multiplied by its arm. (Moment divided by a constant is used to simplify balance calculations by reducing the number of digits).
Reference Datum	An imaginary vertical plane from which all horizontal distances are measured for balance purposes.
Station	A location along the airplane fuselage usually given in terms of distance from the reference datum.
Tare	The weight of chocks, blocks, stands, etc. used when weighing an airplane, and is included in the scale readings. Tare is deducted from the scale reading to obtain the actual (net) airplane weight.
Unusable Fuel	Fuel remaining after a run-out test has been completed in accordance with Federal regulations.
Usable Fuel	Usable Fuel available for aircraft engine combustion.
Useful Load	The basic empty weight subtracted from the maximum weight of the aircraft. This load consists of the pilot, crew (if applicable), useable fuel, passengers, and baggage.



MEASUREMENT CONVERSION TABLES

On the following pages are conversion tables and charts to and from U.S. weights and measures to metric and imperial equivalents. The conversion tables are included to help pilots who live in countries other than the United States or pilots from the United States who are traveling to or within other countries.

LENGTH

U. S. Customary Unit	Metric Equivalents
1 inch	2.54 centimeters
1 foot	0.3048 meter
1 yard	0.9144 meter
1 mile (statute, land)	1,609 meters
1 mile (nautical, international)	1,852 meters

AREA

U. S. Customary Unit	Metric Equivalents
1 square inch	6.4516 sq. centimeters
1 square foot	929 sq. centimeters
1 square yard	0.836 sq. meter

VOLUME OR CAPACITY

U. S. Customary Unit	Metric Equivalents
1 cubic inch	16.39 cubic centimeters
1 cubic foot	0.028 cubic meter
1 cubic yard	0.765 cubic meter

U.S. Customary Liquid Measure

U.S. Customary	Metric Equivalents
1 fluid ounce	29.573 milliliters
1 pint	0.473 liter
1 quart	0.946 liter
1 gallon	3.785 liters

U.S. Customary Dry Measure

U.S. Customary	Metric Equivalents
1 pint	0.551 liter
1 quart	1.101 liters

British Imperial Liquid and Dry Measure

U. S. Equivalents	Metric Equivalents
0.961 U.S. fluid ounce	28.412 milliliters
1.734 cubic inches	
1.032 U.S. dry pints	568.26 milliliters
1.201 U.S. liquid pts.	
34.678 cubic inches	
1.032 U.S. dry quarts	1.136 liters
1.201 U.S. liquid qts.	
69.354 cubic inches	
1.201 U.S.	4.546 liters
277.420 cubic inches	



WEIGHT

**U. S. Customary Unit Metric Equivalents
(Avoir du pois)**

1 grain 64.79891 milligrams
 1 dram 1.772 grams
 1 ounce 28.350 grams
 1 pound 453.6 grams

PRESSURE

U.S. Customary Unit Metric Equivalents

1 PSIG 6.895 KPA
 1 inch Hg 3.388 KPA
 1 inch Hg 25.40 mm Hg

COMMON CONVERSIONS

1 pound/square foot 0.488 kg/meter square
 1 pound/square inch 2.036 inch Hg
 1 pound/HP 0.4538 kg/HP

ATMOSPHERIC PRESSURE RELATIONSHIPS (IN. HG AND HECTOPASCAL)

PRESSURE							
In. Hg	hPa	In. Hg	hPa	In. Hg	hPa	In. Hg	hPa
27.70	938	28.70	972	29.70	1006	30.65	1038
27.75	940	28.75	974	29.75	1007	30.70	1040
27.80	941	28.80	975	29.80	1009	30.75	1041
27.85	943	28.85	977	29.85	1011	30.80	1043
27.90	945	28.90	979	29.90	1013	30.85	1045
27.95	946	28.95	980	29.92	1013	30.90	1046
28.00	948	29.00	982	29.95	1014	30.95	1048
28.05	950	29.05	984	30.00	1016	31.00	1050
28.10	952	29.10	985	30.05	1018	31.05	1051
28.15	953	29.15	987	30.10	1019	31.10	1053
28.20	955	29.20	989	30.15	1021	31.15	1055
28.25	957	29.25	991	30.20	1023	31.20	1057
28.30	958	29.30	992	30.25	1024	31.25	1058
28.35	960	29.35	994	30.30	1026	31.30	1060
28.40	962	29.40	996	30.35	1028	31.35	1062
28.45	963	29.45	997	30.40	1029	31.40	1063
28.50	965	29.50	999	30.45	1031	31.45	1065
28.55	967	29.55	1001	30.50	1033	31.50	1067
28.60	969	29.60	1002	30.55	1035	31.55	1068
28.65	970	29.65	1004	30.60	1036	31.60	1070



USE OF THE TERMS *WARNING*, *CAUTION* AND *NOTE*

The following conventions will be used for the terms *Warning*, *Caution* and *Note*:

-WARNING-

The use of a Warning symbol means that information which follows is of critical importance and concerns procedures and techniques which could cause or result in personal injury or death if not carefully followed.

-CAUTION-

The use of the Caution symbol means information which follows is of significant importance and concerns procedures and techniques which could cause or result in damage to the airplane and/or its equipment if not carefully followed.

-NOTE-

The use of the term Note means the information that follows is essential to emphasize.



TABLE OF CONTENTS

TITLE	SECTION
INTRODUCTION	2-3
NOISE LIMITS	2-3
AIRSPED LIMITATIONS	2-4
AIRSPED MARKINGS	2-5
POWER PLANT LIMITATIONS	2-6
POWER PLANT INSTRUMENT MARKINGS	2-7
FUEL LIMITATIONS	2-8
WEIGHT LIMITS	2-8
CENTER OF GRAVITY LIMITS (GEAR DOWN)	2-8
MANEUVER LIMITS	2-9
FLIGHT LOAD FACTOR LIMITS	2-9
FLIGHT CREW	2-9
OPERATING LIMITATIONS	2-9
KINDS OF OPERATION LIMITS	2-9
KINDS OF OPERATION EQUIPMENT LIST	2-10
TYPES OF OPERATION	2-11
GENERAL	2-11
OXYGEN SYSTEM	2-11
G1000 SYSTEM	2-11
ADVISORY MESSAGES	2-13
DECALS, PLACARDS AND PANELS	2-14
CABIN INTERIOR - Decals & Placards	2-14
CABIN INTERIOR - Panels	2-17
CABIN INTERIOR - Panels	2-18
FUSELAGE INTERIOR	2-19
EXTERIOR	2-20
EXTERIOR	2-21



BLANK



INTRODUCTION

SECTION II includes the mandatory operating limitations, instrument markings, and basic placards necessary for the safe operation of the airplane, its engine, standard systems and standard equipment.

The limitations included in this section have been approved by the Federal Aviation Administration.

When applicable, limitations associated with optional systems or equipment such as autopilots are included in SECTION IX.

-NOTE-

The airspeeds listed in the Airspeed Limitations chart (Figure 2-1) and the Airspeed Indicator Markings chart (Figure 2-2) are based on Airspeed Calibration data shown in SECTION V with the normal static source. If the alternate static source is being used, ample margins should be observed to allow for the airspeed calibration variations between the normal and alternate static sources as shown in SECTION V. When the alternate static system source is first opened, there will be an immediate change to VS and ALT indications. The amount of indicated change will vary based on the current airspeed. The ALT indication will change to calibrated levels after the pressure stabilizes. (Refer to Section V for correction charts.) The autopilot will react to these changes if it is engaged in ALT HOLD mode.

Your Mooney is certificated under FAA Type Certificate No. 2A3 as a Mooney M20V.

NOISE LIMITS

The certificated noise level per 14 CFR Part 36, Appendix G, Amendment 36-28 of the Federal Aviation Regulations for the Mooney M20V, with the Hartzell 3 blade propeller installed at 3368 lbs (1528 Kg.) maximum weight is 78.0 dB(A). No determination has been made by the Federal Aviation Administration that the noise levels of this airplane are or should be acceptable or unacceptable for operation at, into, or out of, any airport.



AIRSPEED LIMITATIONS

Airspeed limitations and their operational significance are shown in Figure 2-1. This calibration assumes zero instrument error.

V/SPEED		KCAS/KIAS	REMARKS
V _{NE}	Never Exceed Speed	196/195	Do not exceed this speed in any operation.
V _{NO}	Maximum Structural Cruising Speed	175/174	Do not exceed this speed except in smooth air, and then only with caution.
V _A	Maneuvering Speed at: lbs. /Kg. 2232/1012 104/103 2430/1102 109/108 3300/1497 127/126 3368/1528 128/127		Do not make full or abrupt control movement above this speed.
V _{FE}	Maximum Flap Extended Speed	111/110	Do not exceed this speed with flaps in all extended positions.
V _{LE}	Maximum Landing Gear Extended Speed	166/165	Maximum speed at which the aircraft can be safely flown with the landing gear extended.
V _{LO (EXT)}	Max. Speed for Gear Extension	141/140	Max. speed at which the landing gear can be safely extended.
V _{LO (RET)}	Max. Speed for Gear Retraction	107/106	Maximum speed at which the landing gear can be safely retracted.
	Maximum Pilot Window Open Speed	133/132	Do not exceed this speed with pilot window open.

**Figure 2-1
AIRSPEED LIMITATIONS**



AIRSPEED MARKINGS

Airspeed indicator markings, their color code and operational significance are shown in Figure 2-2.

G- 1000 AIRSPEED INDICATOR & STANDBY MARKINGS		
MARKING	IAS / STANDBY	SIGNIFICANCE
Red band	20 KIAS – 59 KIAS	Low speed awareness - stall is imminent
Yellow band	59 KIAS – 66 KIAS	Lower limit of white band - approaching stall
White band	66 KIAS – 110 KIAS	Operating range with flaps in all extended positions
Green band	66 KIAS – 174 KIAS	Normal operating range
Yellow band	174 KIAS - 195 KIAS	Caution range - smooth air only
Red/White barber pole	195 KIAS and greater	195 KIAS is the maximum speed for all operations

**Figure 2-2
AIRSPEED INDICATOR & STANDBY MARKINGS**

The airspeed indicator is marked in IAS values.



POWER PLANT LIMITATIONS

Number of Engines	1
Engine Manufacturer	Continental Motors Incorporated (CMI)
Engine Model Number	(S/N 33- 0001 and On) TSIO- 550- G (5)
Recommended Time Between Overhaul	2200 Hours (Time in Service)
Engine Operating Limits for Takeoff and Continuous Operations:	
Maximum Recommended Cruise (For Leaning)	262 HP
Maximum Continuous Power	
.....	280 BHP
Maximum Continuous RPM	2500 RPM
Maximum Recommended Continuous Cylinder Head Temperature	420° F (215.6° C)
.....	460° F (237.7° C)
Maximum Cylinder Head Temperature	460° F (237.7° C)
Maximum Turbine Inlet Temperature (TIT) ..	1750° F (954° C)/1850° F (1010° C) for 30 Sec.
Maximum Oil Temperature	240° F (116° C)
Minimum Oil Temperature - Takeoff	100° F (38° C)
Recommended Cruising Oil Temperature	170° F- 220° F (76.7° C- 104.4° C)
Maximum Manifold Pressure	33.5 Inches of Hg
Oil Pressure	
Normal Operating	30- 100 PSI
Minimum (IDLE ONLY)	10 PSI
Maximum Allowable (Cold Oil)	100 PSI
Oil Grades Recommended for Various Average Air Temperature Ranges	
Below 40° F (4° C)	SAE 30, 10W30, 15W50 or 20W50
Above 40° F (4° C)	SAE 50, 15W50 or 20W50
Fuel Grade (Color)	100LL (Blue) or 100 octane (Green) ¹
Fuel Flow	
Normal Operations	7 to 32 GPH (27 to 121 LPH)
Number of Propellers	1
Propeller Manufacturer	Hartzell
Propeller Hub/Blade Model Number	PHC- J3YF- 1RF/F7498
The (B) denotes a booted prop (for TKS)	PHC- J3YF- 1RF/F7498(B)
Number of Blades	3
Propeller Diameter:	
Min	74 In. (188.0 cm.)
Max	76 In. (193.0 cm.)
Propeller Blade Angles @ 30.0 In. sta.:	
Low	17.0 Degrees +/- 0.2 Degrees
High	38.0 Degrees +/- 1.0 Degrees
Propeller Operating Limits	2500 RPM
¹ 100LL fuel is calibrated at 5.82 lb/gal (0.69 Kg/liter)	
100 octane fuel is calibrated at 6.0 lb./gal. (0.72 Kg/liter)	



POWER PLANT INSTRUMENT MARKINGS

Power plant instrument markings and their color code significance are shown in the table below.

-NOTE-

When an indication lies in the caution range, the legend for that display will change to the color of the caution range. When an indication lies in the upper or lower prohibited range, the legend for that display will change to the color of the prohibited range and will begin flashing as well.

INDICATION	Red arc / bar = Lower prohibited range	Yellow arc / bar = Caution range	Green arc / bar = Normal operating range	Yellow arc / bar = Caution range	Red arc / bar = Upper prohibited range
Engine RPM	-	-	2200 – 2500	-	2500*
Manifold Press. In. Hg	-	-	15 – 33.5**	-	33.5
Oil Temp °F	-	-	100 – 240	-	240
Oil Press PSI	10 (Idle)	10 – 30	30 – 100	-	100 (Cold)
Cyl. Head Temp °F	-	-	240 – 460	-	460
Turbine Inlet Temp. °F	-	-	1000 - 1750	-	1750

*To prevent nuisance alerts during normal takeoffs: the “RPM” data will not turn red or flash until the RPM exceeds 2540.

** No color scale is depicted, and manifold pressure should be within this range.



FUEL LIMITATIONS

-WARNING-

Takeoff maneuvers when the selected fuel tank contains less than 12 gallons (45.4 liters) of fuel have not been demonstrated.

-NOTE-

Each fuel quantity gauge is calibrated to read zero only in coordinated level flight when remaining quantity of fuel can no longer be safely used.

-NOTE-

An optional visual fuel quantity gauge is installed on top of each tank and is to be used as a reference for refueling tanks only.

Standard Tanks (2) 47.5 U.S. Gal. each (179.8 liters)
Total Fuel Capacity - Standard (see Chapter XI for Optional) 95 U.S. Gal. (359.6 liters)
Usable Fuel 89 U.S. Gal. (336.9 liters)
Unusable Fuel: 6 U.S. Gal. (22.7 liters)
Fuel Grade (and color): 100LL (low lead) (blue) or 100 octane (green) is approved

-CAUTION-

Ethylene glycol monomethyl ether (EGME) or other additives are not recommended due to potential deteriorating effects within the fuel system. Under certain conditions of temperature and humidity, water can be present in fuel in sufficient quantities to create ice formations within the fuel system. To prevent this, add Anhydrous ISOPROPYL Alcohol to the fuel supply in quantities not to exceed 3% of total fuel volume per tank.

WEIGHT LIMITS

Maximum Weight - Takeoff 3368 lb. (1528 Kg.)
Maximum Weight - Landing 3200 lb. (1452 Kg.)
Maximum Weight in Baggage Compartment 120 lb.
..... (54.4 Kg.) @ Fus. Sta. 101.5 (253.7 cm.)
Maximum Weight in Rear Storage Area 10 lb.
..... (4.54 Kg.) @ Fus. Sta. 131.0 (297.5 cm.)
Maximum Weight in Cargo Area (Rear seats folded down) 340 lbs.
..... (154.2 KG) @ Fus. Sta. 70.7 (176.8 cm.)

CENTER OF GRAVITY LIMITS (GEAR DOWN)

Most Forward Fus. Sta. 41.0 IN. (104.1 cm.) @ 2430 lb. (1102 Kg)
..... 16.79% MAC
Intermediate Forward Fus. Sta. 44 IN. (111.7 cm.) @ 3300 lb. (1497 Kg)
..... 21.7% MAC
Forward Gross Fus. Sta. 46.0 IN. (116.8 cm.) @ 3368 lb. (1528 Kg)
..... 24.98% MAC
Aft Gross Fus. Sta. 51.0 IN. (129.5 cm.) @ 3368 lb. (1528 Kg)
..... 33.18% MAC
MAC (at Wing Sta. 94.85)(241 cm.) 61.00 In.
Datum (station zero) is 13 inches (32.5 cm.) aft of the centerline of the nose gear trunnion attach/pivot bolts.

MANEUVER LIMITS

This airplane must be operated as a Normal Category airplane. Aerobatic maneuvers, including spins, are prohibited.



-NOTE-

Up to 500 foot altitude loss may occur during stalls at maximum weight.

FLIGHT LOAD FACTOR LIMITS

Maximum Positive Load Factor	
Flaps Up	+3.8 g.
Flaps Down (33 Degrees)	+2.0 g.
Maximum Negative Load Factor	
Flaps Up	- 1.5 g.
Flaps Down	0.0 g.

FLIGHT CREW

Pilot	One
Maximum passenger seating configuration	Three

OPERATING LIMITATIONS

When aircraft is not equipped with an approved oxygen system and flight operations above 12,000 ft. are desired, this airplane must be:

1. Equipped with supplemental oxygen in accordance with FAR 23.1441
2. Operate in accordance with FAR 91.211 and,
3. Equipped with avionics in accordance with FAR 91 or FAR 135.

ALTERNATOR OPERATING LIMITATIONS IS 94 AMPS.

Above 30.5 inHg of manifold pressure only full rich mixture is permitted. At altitudes above 22,000 feet, power settings above 2300 RPM must be operated at 1675° F TIT or richer.

Above 12,000 ft. the minimum manifold pressure is 15 inHg and the minimum RPM is 2,000.

KINDS OF OPERATION LIMITS

This is a Normal Category airplane certified for VFR/IFR day or night operations when the required equipment is installed and operational as specified in the KINDS OF OPERATION EQUIPMENT LIST and the applicable operating rules.

Optional equipment installations may not be required to be operational.

The pilot must determine that the applicable operating rules requirements for each kind of operation are met.

OPERATIONS IN KNOWN ICING CONDITIONS ARE PROHIBITED.

KINDS OF OPERATION EQUIPMENT LIST

The following equipment was approved during Type Certification and must be installed and operable for each kind of operation as specified.

-NOTE-

The KINDS OF OPERATION EQUIPMENT list may not include all the equipment as required by applicable operating rules.



KINDS OF OPERATION EQUIPMENT LIST

SYSTEM or COMPONENT	VFR DAY ¹	VFR NIGHT	IFR DAY	IFR NIGHT
AIRSPPEED INDICATOR	1	1	1	1
ALTIMETER, SENSITIVE	1	1	1	1
MAGNETIC DIRECTION INDICATOR	1	1	1	1
PRIMARY FLIGHT DISPLAY ²	1	1	1	1
MULTI- FUNCTION DISPLAY	-	-	1	1
AUDIO PANEL	-	-	1	1
AIR DATA COMPUTER	1	1	1	1
ATTITUDE AND HEADING REFERENCE SYSTEM	-	-	1	1
GPS	-	1	2	2
LANDING GEAR POSITION INDICATOR	2	2	2	2
SEAT BELT & SHOULDER HARNESS FOR EACH OCCUPANT ³	1	1	1	1
OXYGEN MASK FOR EACH OCCUPANT ⁴	1	2	1	2
POSITION LIGHTS	-	3	-	3
STROBE LIGHTS (ANTI- COLLISION)	-	3	-	3
GYRO- HORIZON	-	-	1	1
LANDING LIGHT ⁵	-	1	-	1
INSTRUMENT LIGHTS (INTERNAL or GLARESHIELD)	-	1	-	1
BATTERIES	2	2	2	2
FUEL BOOST PUMP	1	1	1	1
PILOT'S OPERATING HANDBOOK & AIRPLANE FLIGHT MANUAL	1	1	1	1
PITOT, HEATED ⁵	-	-	1	1
ELT	1	1	1	1
ALTERNATE STATIC SOURCE ⁵	-	-	1	1
¹ Equipment must be installed and operable for all operations ² If the PFD is inoperative or removed for service, the MFD may be used as the PFD. The MFD display must be operated in PFD (reversionary) mode by depressing the reversionary button on the Audio Panel. When operating in reversionary mode the system is limited to DAY VFR operations only. ³ If inoperative for unoccupied seat(s), seat(s) must be placarded, "DO NOT OCCUPY" ⁴ Only required when the operating rules require use of oxygen ⁵ When required by the appropriate regulations				

TYPES OF OPERATION

The airplane is approved for the following operations when equipped in accordance with FAR 91 or FAR 135.

1. Day V.F.R.
2. Night V.F.R
3. Day I.F.R.
4. Night I.F.R.
5. Non-Icing



GENERAL

OXYGEN SYSTEM: (Refer to Supplemental Information Section IX)

G1000 System:

1. The GARMIN G1000 Cockpit Reference Guide for the M20V Series aircraft, P/N 190-02285-00, Revision A or later FAA approved revision must be immediately available to the flight crew.

-WARNING-

Do not load a new arrival or departure procedure in the flight plan if one currently exists without first removing the existing arrival or departure procedure. Failing to observe this limitation can cause erroneous course deviation indications, loss of GPS navigation information, and other display anomalies.

-NOTE-

If display anomalies are noted after editing the flight plan, perform either a direct to or activate leg operation as appropriate on the flight plan to ensure correct flight plan sequencing and guidance.

2. The GARMIN G1000 must utilize the following or later FAA approved software versions: The database version should be 0401.35 or later FAA approved version.

SYSTEM STATUS PAGE NAME	SOFTWARE PART NUMBER	SOFTWARE VERSION
GDC1- GIA1	006- B0261- 03	2.05
GDC1 FPGA	006- C0055- 00	01.05
GDL69	006- B0317- 03	2.14.00
GEA1- GIA1	006- B0193- 02	2.04
GEA1- GIA2	006- B0193- 02	2.04
GIA1	006- B0190- 13	2.08
GIA2	006- B0190- 13	2.08
GMA1- GIA1	006- B0203- 10	2.11
GMA1- GIA2	006- B0203- 10	2.11
GMU1	006- B0224- 00	2.01
GMU1 FPGA	006- C0048- 00	2.00
GPS1	006- B0093- XX	3.01
GPS2	006- B0093- XX	3.01
GRS1- GIA1	006- B0223- 02	2.03
GRS1- GIA2	006- B0223- 02	2.03
GRS1 FPGA	006- B0049- 00	2.00
GTX- GIA1	006- B0172- XX	4.02
GTX- GIA2	006- B0172- XX	4.02
MFD1	006- B0319- 27	4.06
PFD1	006- B0319- 27	4.06

The database version is displayed on the MFD power- up page immediately after system power- up and must be acknowledged. The remaining system software versions can be verified on the AUX group sub- page 5, "AUX – SYSTEM STATUS."



3. IFR enroute, oceanic and terminal navigation predicated upon the G1000 GPS Receiver is prohibited unless the pilot verifies the currency of the database or verifies each selected way-point for accuracy by reference to current approved data.
4. Instrument approach navigation predicated upon the G1000 GPS Receiver must be accomplished in accordance with approved instrument approach procedures that are retrieved from the GPS equipment database. The GPS equipment database must incorporate the current update cycle.
 - a.) Instrument approaches utilizing the GPS receiver must be conducted in the approach mode and Receiver Autonomous Integrity Monitoring (RAIM) must be available at the Final Approach Fix.
 - b.) Accomplishment of ILS, LOC, LOC- BC, LDA, SDF, MLS or any other type of approach not approved for GPS overlay with the G1000 GPS receiver is not authorized.
 - c.) Use of the G1000 VOR/ILS receiver to fly approaches not approved for GPS require VOR/ILS navigation data to be valid on the PFD display.
 - d.) When an alternate airport is required by the applicable operating rules, it must be served by an approach based on other than GPS navigation, the aircraft must have the operational equipment capable of using that navigation aid, and the required navigation aid must be operational.
 - e.) VNAV information may be utilized for advisory information only. Use of VNAV information for Instrument Approach Procedures does not guarantee step- down fix altitude protection, or arrival at approach minimums in a normal position to land. VNAV also does not guarantee compliance with intermediate altitude constraints between the top of descent and the way-point where the VNAV path terminates in terminal or enroute operations.
5. If not previously defined, the following default settings must be made in the “SYSTEM SETUP” menu of the G1000 prior to operation (refer to Pilot’s Guide for procedure, if necessary).
 - a.) DIS, SPD..... $\overset{n}{m}$ $\overset{k}{t}$ (sets navigation units to “nautical miles” and “knots”)
 - b.) ALT, VS..... $\overset{f}{t}$ fpm (sets altitude units to “feet” and “feet per minute”)
 - c.) MAP DATUM....WGS 84 (sets map datum to WGS- 84, [see note below])
 - d.) POSITION.....deg- min (sets navigation grid units to decimal minutes) example: dd.mm.ss: 45° 30’ 30” in decimal minutes are: 45° 30.5’

-NOTE-

In some areas outside the United States, datums other than WGS-84 or NAD-83 may be used. If the G1000 is authorized for use by the appropriate Airworthiness authority, the required geodetic datum must be set in the G1000 prior to its use for navigation.

6. Operation is prohibited north of 70° N and south of 70° S latitudes. In addition, operation is prohibited in the following two regions:
 - a.) North of 65° N between 75° W and 120°W longitude and
 - b.) South of 55° S between 120° E and 165° E longitude.

-CAUTION-

CDI mode sequencing (GPS-to-ILS) must be set to manual for instrument approaches conducted with the autopilot coupled.



ADVISORY MESSAGES

The G1000 Cockpit Reference Guide and the G1000 Pilot's Guide contain detailed descriptions of the annunciator system and all advisory messages. These messages appear on the PFD for flight crew awareness.

The following warnings and cautions may appear in various locations on the PFD or MFD. Consult the G1000 Cockpit Reference Guide and the G1000 Pilot's Guide for detailed descriptions of each annunciation as necessary.

ANNUNCIATION	CAUSE
AHRS Aligning – Keep Wings Level	Attitude and Heading Reference System is aligning. Keep wings level using standby attitude indicator.
ATTITUDE FAIL	Display system is not receiving attitude reference information from the AHRS; accompanied by the removal of sky/ground presentation and a red X over the attitude area.
AIRSPEED FAIL	Display system is not receiving airspeed input from the air data computer; accompanied by a red X through the airspeed display.
ALTITUDE FAIL	Display system is not receiving airspeed input from the air data computer; accompanied by a red X through the altimeter display.
VERT SPEED FAIL	Display system is not receiving vertical speed input from the air data computer; accompanied by a red X through the vertical speed display.
HDG	Display system is not receiving valid heading input from the AHRS; accompanied by a red X through the digital heading display.
Red X	A red X through any display field, such as COM frequencies, NAV frequencies, or engine data, indicates that display field is not receiving valid data.



DECALS, PLACARDS AND PANELS

CABIN INTERIOR

Decals & Placards - The following placards are relevant to proper operation of the airplane and must be installed inside the cabin at the locations specified. When ordering replacement Decals and Placards, refer to the Mooney International Corporation M20V IPC or call Mooney Service Parts Dept.

**WHEN ORDERING DECALS & PLACARDS
CONTACT MOONEY SERVICE PARTS DEPT.**

SPEEDBRAKE EQUIPPED: FOR OPERATING INSTRUCTION
AND LIMITATIONS SEE FAA APPROVED AFM SUPPLEMENT
OR PILOT'S OPERATING HANDBOOK.

150110-A1001W
(OPTIONAL)
ON INSTRUMENT
PANEL
(CLEAR W/WHITE TEXT)



150110-P1004
ON INSTRUMENT
PANEL (ENGRAVED)
(BLACK W/WHITE TEXT)

LIGHTNING DETECTION
EQUIPMENT NOT TO BE
USED FOR THUNDERSTORM
AREA PENETRATION

150110-A3017W
(OPTIONAL)
ON INSTRUMENT
PANEL
(CLEAR W/WHITE TEXT)

**DO NOT OPEN
ABOVE 132 KIAS**

150110-A1031B
(CLEAR W/BLACK TEXT)

BELOW
PILOT'S
STORM
WINDOW

BETWEEN SEATS ON
EMERGENCY GEAR RELEASE
EXTENSION HANDLE



ENGRAVED ON (CWS A/P DISC TRIM INTR)
CONTROL YOKE
(BLACK W/WHITE TEXT)

← PUSH TO RELEASE

150110-A1040W
(CLEAR W/WHITE TEXT)

ON LEFT SIDE PANEL IN PILOT'S VISION

<p style="text-align: center;">OPERATING LIMITATIONS</p> <p>THE MARKINGS AND PLACARDS INSTALLED IN THIS AIRPLANE CONTAIN OPERATING LIMITATIONS WHICH MUST BE COMPLIED WITH WHEN OPERATING THIS AIRPLANE IN THE NORMAL CATEGORY. THIS AIRPLANE IS CERTIFIED FOR DAY AND NIGHT VFR/IFR OPERATION AND FLIGHT INTO KNOWN ICING WHEN THE REQUIRED EQUIPMENT IS INSTALLED AND OPERATIONAL. NO AEROBATIC MANEUVERS, INCLUDING SPINS ARE APPROVED. OTHER OPERATING LIMITATIONS WHICH MUST BE COMPLIED WITH WHEN OPERATING THIS AIRPLANE IN THIS CATEGORY ARE CONTAINED IN THE FLIGHT MANUAL. MANEUVERING SPEED (3368 LBS.), 127 KIAS.</p>	<p style="text-align: center;">OPERATING LIMITATIONS</p> <p>THE MARKINGS AND PLACARDS INSTALLED IN THIS AIRPLANE CONTAIN OPERATING LIMITATIONS WHICH MUST BE COMPLIED WITH WHEN OPERATING THIS AIRPLANE IN THE NORMAL CATEGORY. THIS AIRPLANE IS CERTIFIED FOR DAY AND NIGHT VFR/IFR OPERATION WHEN THE REQUIRED EQUIPMENT IS INSTALLED AND OPERATIONAL. FLIGHT INTO KNOWN ICING CONDITIONS IS PROHIBITED. NO AEROBATIC MANEUVERS, INCLUDING SPINS ARE APPROVED. OTHER OPERATING LIMITATIONS WHICH MUST BE COMPLIED WITH WHEN OPERATING THIS AIRPLANE IN THIS CATEGORY ARE CONTAINED IN THE AIRPLANE FLIGHT MANUAL. MANEUVERING SPEED (3368 LBS.), 127 KIAS.</p>
<p style="text-align: center;">EMERGENCY MANUAL GEAR EXTENSION</p> <ol style="list-style-type: none"> 1. PULL LANDING GEAR ACTUATOR CIRCUIT BREAKER. 2. PUT GEAR SWITCH IN GEAR DOWN POSITION. 3. PUSH RELEASE TAB FORWARD AND LIFT UP RED HANDLE. 4. PULL T-HANDLE STRAIGHT UP (12 TO 20 INCHES). 5. ALLOW T-HANDLE TO RETURN TO ORIGINAL POSITION. 6. REPEAT UNTIL GEAR DOWN LIGHT COMES ON (12-20 PULLS). IF TOTAL ELECTRICAL FAILURE-SEE MECHANICAL INDICATOR. 	<p style="text-align: center;">EMERGENCY MANUAL GEAR EXTENSION</p> <ol style="list-style-type: none"> 1. PULL LANDING GEAR ACTUATOR CIRCUIT BREAKER. 2. PUT GEAR SWITCH IN GEAR DOWN POSITION. 3. PUSH RELEASE TAB FORWARD AND LIFT UP RED HANDLE. 4. PULL T-HANDLE STRAIGHT UP (12 TO 20 INCHES). 5. ALLOW T-HANDLE TO RETURN TO ORIGINAL POSITION. 6. REPEAT UNTIL GEAR DOWN LIGHT COMES ON (12-20 PULLS). IF TOTAL ELECTRICAL FAILURE-SEE MECHANICAL INDICATOR.
<p style="text-align: center;">CAUTION</p> <ol style="list-style-type: none"> 1. TURN OFF STROBE LIGHTS WHEN TAXIING NEAR OTHER AIRCRAFT OR FLYING IN FOG OR IN CLOUDS. STANDARD POSITION LIGHTS MUST BE USED FOR ALL NIGHT OPERATIONS. 2. IN CASE OF FIRE TURN OFF CABIN HEAT. 3. DO NOT SCREW VERNIER CONTROLS CLOSER THAN 1/8" FROM NUT FACE. 	<p style="text-align: center;">CAUTION</p> <ol style="list-style-type: none"> 1. TURN OFF STROBE LIGHTS WHEN TAXIING NEAR OTHER AIRCRAFT OR FLYING IN FOG OR IN CLOUDS. STANDARD POSITION LIGHTS MUST BE USED FOR ALL NIGHT OPERATIONS. 2. IN CASE OF FIRE TURN OFF CABIN HEAT. 3. DO NOT SCREW VERNIER CONTROLS CLOSER THAN 1/8" FROM NUT FACE.

150110-B1024B (BLACK W/WHITE TEXT) TKS
150110-Q1024 (BLACK W/SILVER TEXT)
REFER TO SUPPLEMENT IF INSTALLED

NON-TKS 150110-B1025B (BLACK W/WHITE TEXT)
150110-Q1025 (BLACK W/SILVER TEXT)



**RESTRAINT AIRBAG
SYSTEM CHECK**

FRONT SEATS →
REAR SEATS →

BELOW REAR SEAT
150110-A3040W
(OPTIONAL)
(CLEAR W/WHITE TEXT)

**-CHECK VALVE -
HINGE I.D. TO BE
IN UP POSITION** **FUEL
FLOW** →

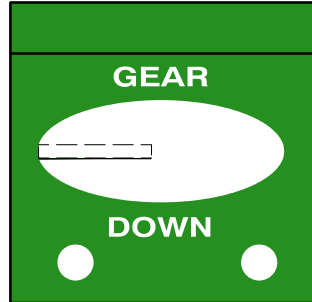

FLOORBOARD
BETWEEN
SEATS

150110-N1015
GREEN & CLEAR PLEXIGLASS

UNDERSIDE OF
FLOORBOARD
ABOVE FUEL
CHECK VALVE
150110-A2032R
(CLEAR W/RED TEXT)

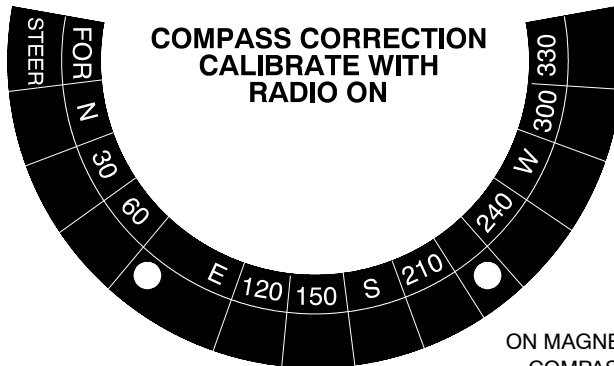

**COMPASS CORRECTION
CALIBRATE WITH
RADIO ON**

ON MAGNETIC
COMPASS
150110-F1016

WARNING **DO NOT EXCEED 10 LBS (4.5Kg) IN THIS COMPARTMENT**
USE FOR STOWAGE OF LIGHT SOFT ARTICLES ONLY
SEE AIRCRAFT LOADING SCHEDULE DATA
FOR BAGGAGE COMPARTMENT ALLOWABLE



BAGGAGE COMPARTMENT ON HAT RACK SHELF

150110-A1044B
(CLEAR W/BLACK TEXT)

WARNING **DO NOT EXCEED 120 LBS**
(54.4 Kg) IN THIS COMPARTMENT
SEE AIRCRAFT LOADING SCHEDULE DATA
FOR BAGGAGE COMPARTMENT ALLOWABLE

TOP OF BAGGAGE
DOOR JAMB
150110-A1046B
(CLEAR W/BLACK TEXT)



WARNING:
DO NOT EXCEED 170 LBS.
(77.1 Kg) ON THIS SEAT BACK
SEE AIRCRAFT LOADING SCHEDULE DATA
FOR BAGGAGE COMPARTMENT ALLOWABLE

FWD END OF
REAR SEAT BOTTOM
STRUCTURE
150110-A1041W
(CLEAR W/WHITE TEXT)

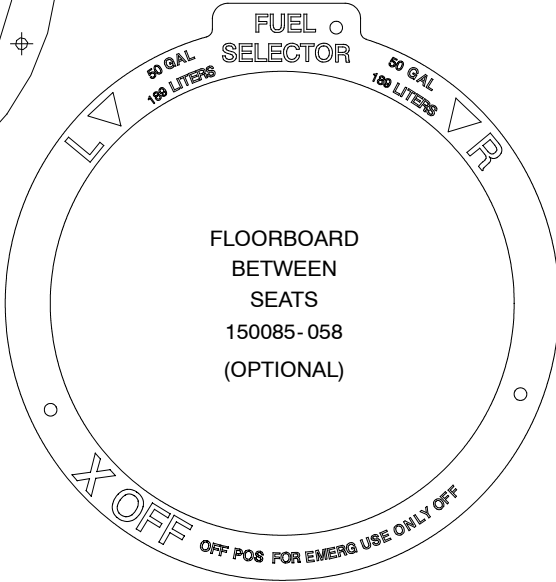
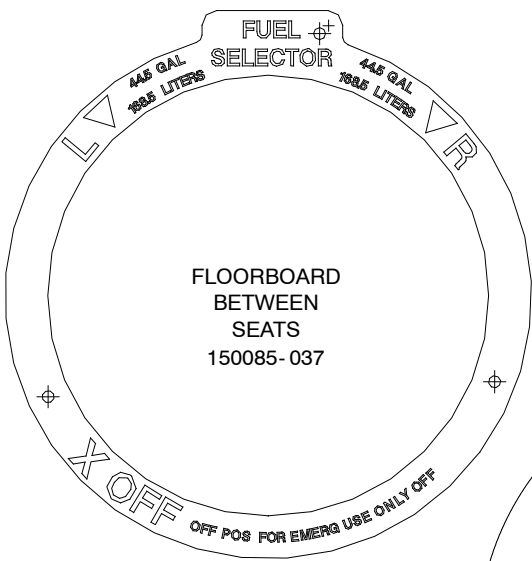

**ALT AIR
PULL ON**

917033-11
CONSOLE ON CONTROL KNOB
ENGRAVED BLACK W/WHITE TEXT

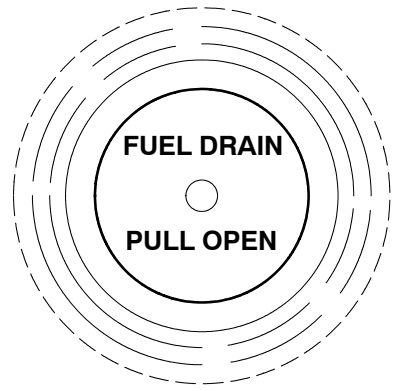

150110-A1036B
FLOORBOARD - FWD OF
CO-PILOT SEAT
(CLEAR W/BLACK TEXT)

ABOVE
INSIDE
BAGGAGE
DOOR
HANDLE

**AUXILIARY EXIT
DO NOT OPEN IN FLIGHT**

TO OPEN

1. PULL OFF COVER
2. PULL CABLE EXTRACTING LOCK PIN
3. ACTUATE HANDLE

TO CLOSE

1. STORE HANDLE
2. INSERT LOCK PIN
3. INSTALL COVER
4. CLOSE AND LATCH DOOR USING OUTSIDE HANDLE
5. LOCK DOOR

150110-A1045B
(CLEAR W/BLACK TEXT)



Panels - The following “Electroluminescent Panels” with backlit reverse engraved nomenclature, relevant to proper operation of the airplane. Replacement panels are available through any Authorized Mooney Service Center, also refer to the M20V Illustrated Parts Catalog when ordering.

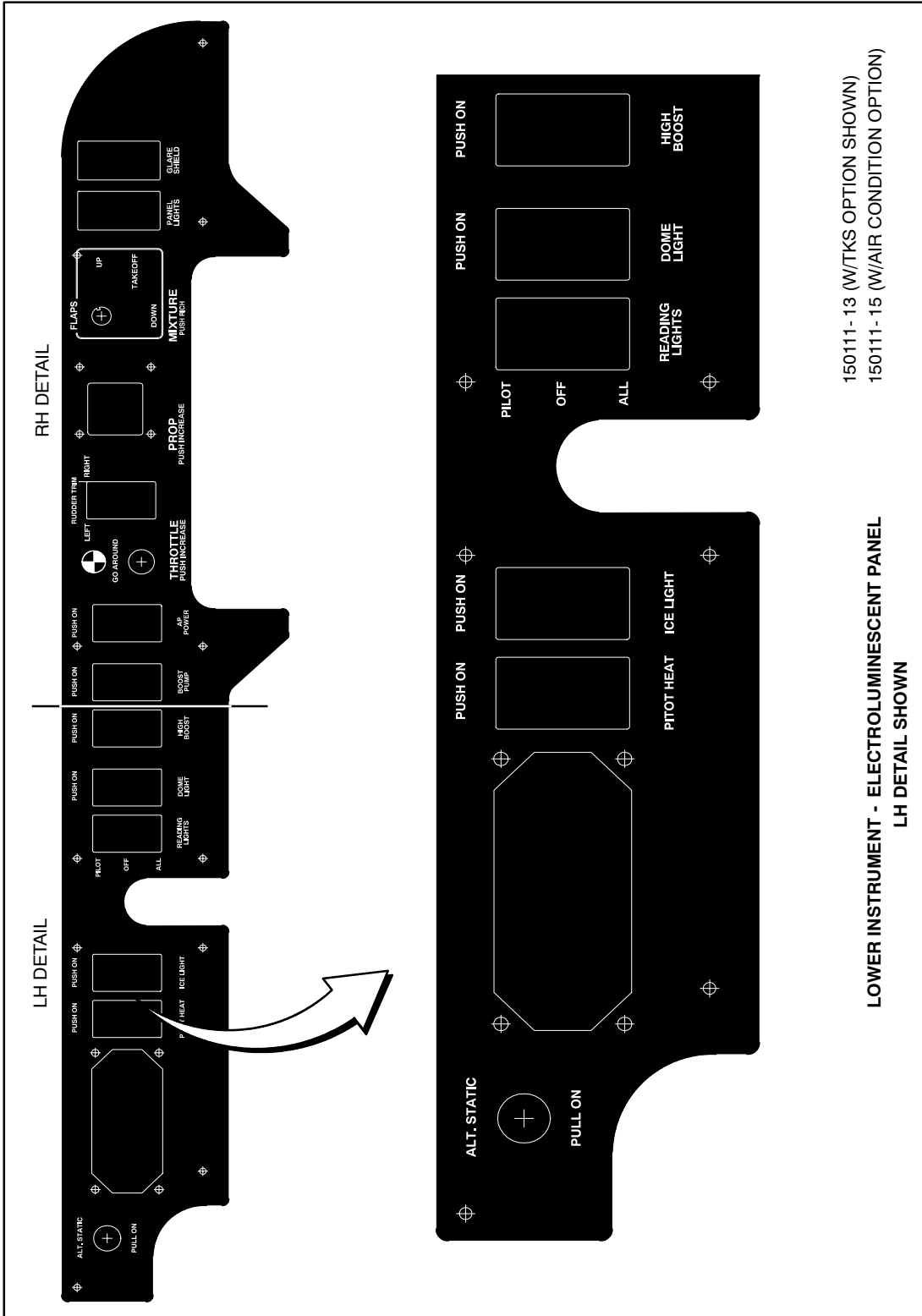

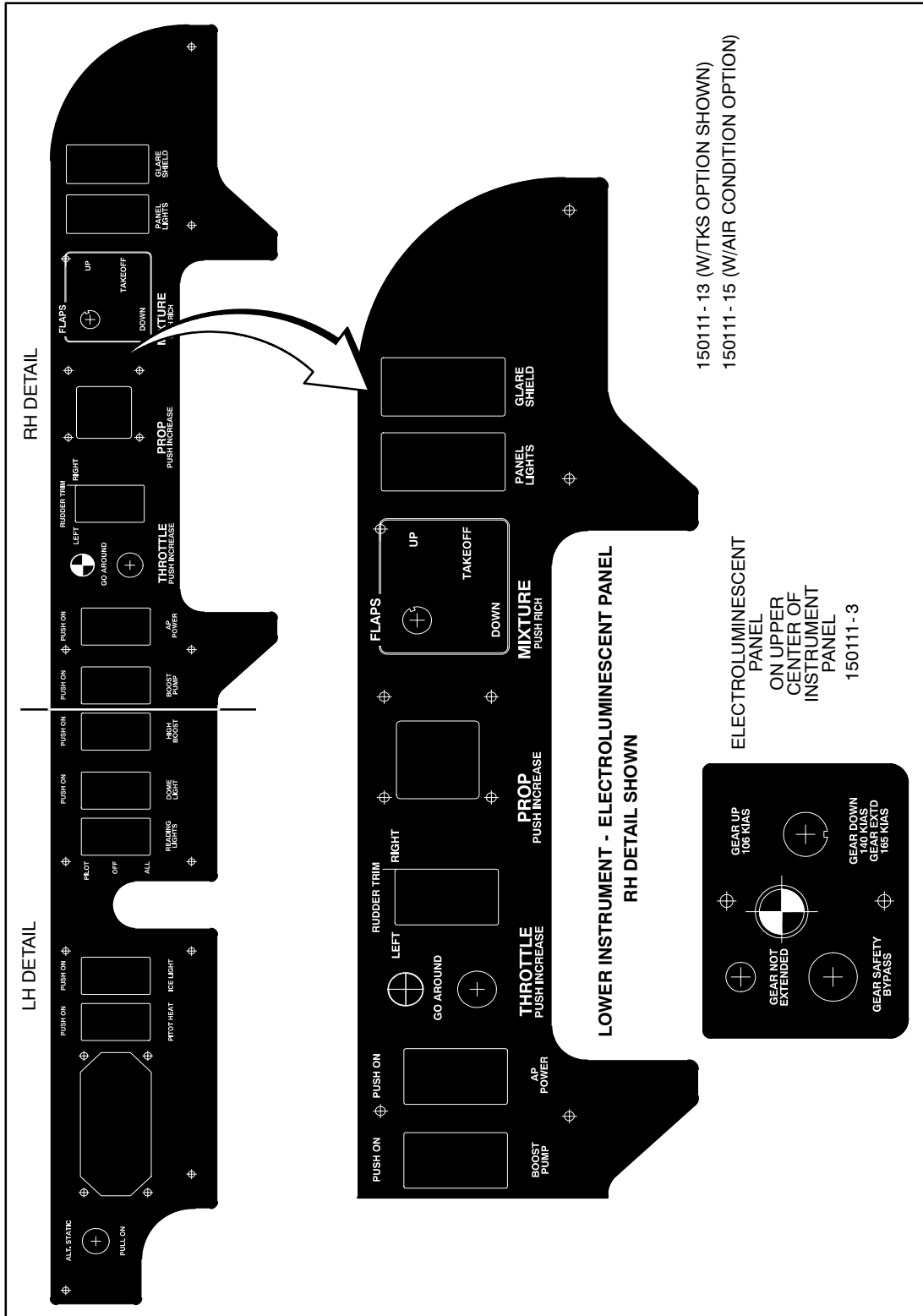

FUSELAGE INTERIOR

The following placards are relevant to proper operation of the airplane and must be installed inside the fuselage at the locations specified. When ordering replacement Decals and Placards, refer to the Mooney International Corporation M20V IPC or call Mooney Service Parts Dept.

<p>MAINTAIN ↓ LEVEL HERE</p>	<p>HYDRAULIC OIL RESERVOIR 150110-A2016W (CLEAR W/WHITE TEXT)</p>	<p>BACKSIDE OF AUX. PWR. RECEPTACLE DOOR</p>	<p>28 VOLTS ONLY</p> <p>150110-A2023B (CLEAR W/BLACK TEXT)</p>
<p>USE AVIATORS OXYGEN ONLY</p> <p>SEE PILOT'S OPERATING HANDBOOK FOR FILLING PRESSURES</p>	<p>INSIDE OXYGEN FILLER DOOR 150110-A2018B (CLEAR W/BLACK TEXT)</p>	<p>ON BATTERY ACCESS PANELS L/H & R/H</p>	<p>BOTH BATTERIES MUST BE INSTALLED FOR FLIGHT</p> <p>150110-A2015R (CLEAR W/RED TEXT)</p>
<p>- ENGINE OIL - OIL INSTALLED IN THIS ENGINE IS</p> <p>NEXT OIL CHANGE DUE AT _____ HRS (USE GREASE PENCIL) TACH TIME</p>		<p>INSIDE ENGINE OIL FILLER DOOR 150110-A2001B (CLEAR W/BLACK TEXT)</p>	



EXTERIOR

The following placards are relevant to proper operation of the airplane and must be installed on the exterior of the aircraft at the locations specified. When ordering replacement Decals and Placards, refer to the Mooney International Corporation M20V IPC or call Mooney Service Parts Dept.

NO STEP

ON INBOARD END OF FLAP
WING LEADING EDGES AND
WING AHEAD OF FLAPS

- 150110-A2006B
- 150110-A2006W (CLEAR W/WHITE TEXT)
- 150110-B2006W (CLEAR W/BLACK TEXT)
- 150110-C2006 (BLACK CUTOUT)
- 150110-B2006 (WHITE CUTOUT)

UNDERSIDE OF WINGS (2 PLCS)
& AFT OF L/H COWL FLAP (1 PLC)

HOIST POINT

- 150110-B2012 (WHITE CUTOUT)
- 150110-C2012 (BLACK CUTOUT)

DO NOT PUSH

HORIZ. STAB. L/E
RUDDER T/E (BOTH SIDES)

- 150110-B2019 (WHITE CUTOUT)
- 150110-C2019 (BLACK CUTOUT)

UNDER TAILCONE
AFT OF WING T/E

STATIC DRAIN

- 150110-A2014B (CLEAR W/BLACK TEXT)
- 150110-A2014W (CLEAR W/WHITE TEXT)

PITOT DRAIN

UNDER LEFT WING L/E
NEAR FUSELAGE

- 150110-A2011B (CLEAR W/BLACK TEXT)
- 150110-A2011W (CLEAR W/WHITE TEXT)

UNDER WING NEAR
SUMP DRAINS

FUEL DRAIN

- 150110-A2013B (CLEAR W/BLACK TEXT)
- 150110-A2013W (CLEAR W/WHITE TEXT)

UNDER FUSELAGE RT. SIDE
AFT OF NOSE WHEEL WELL

**GASCOLATOR
DRAIN**

- 150110-A2010B (CLEAR W/BLACK TEXT)
- 150110-A2010W (CLEAR W/WHITE TEXT)

ON WING
EACH SPEEDBRAKE
LOCATION (OPTIONAL)

Electronically Acutated - DO NOT MANUALLY OPERATE

ON NOSE LANDING
GEAR DOOR

- 150110-A3019B (CLEAR W/BLACK TEXT)
- 150110-A3019W (CLEAR W/WHITE TEXT)

TIRE PRESSURE 49 PSI (3.44 Kg/cm²)

- 150110-A2004B (CLEAR W/BLACK TEXT)
- 150110-A2004W (CLEAR W/WHITE TEXT)

ON MAIN LANDING
GEAR DOOR

TIRE PRESSURE 42 PSI (2.95 Kg/cm²)

- 150110-A2005B (CLEAR W/BLACK TEXT)
- 150110-A2005W (CLEAR W/WHITE TEXT)



TOWING LIMITS

ON NOSE
LANDING GEAR
LEG ASSEMBLY



TOWING LIMITS

- 150110-A2022B (CLEAR W/BLACK TEXT)
- 150110-A2022W (CLEAR W/WHITE TEXT)
- 150110-A2022R (CLEAR W/RED TEXT)

ON NOSE
LANDING GEAR
SPINDLE ASSEMBLY

**WARNING
DO NOT EXCEED
TOWING LIMITS**



- 150110-A2003B (CLEAR W/BLACK TEXT)
- 150110-A2003W (CLEAR W/WHITE TEXT)



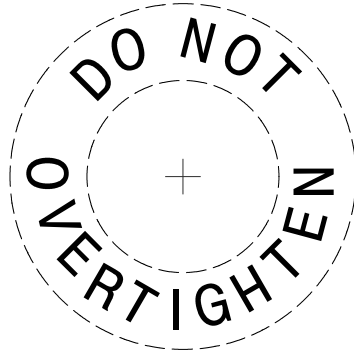

UNDER WING NEAR
SUMP DRAINS

150110-A2025B (CLEAR W/BLACK TEXT)
150110-A2025W (CLEAR W/WHITE TEXT)

AVGAS ONLY

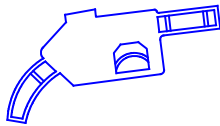

**GRADE
100LL**

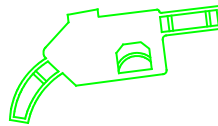

**GRADE
100**

TOP
LEFT/RIGHT WINGS
AT FUEL FILLERS
150110-B2007B
(FULL COLOR PLACARD)

FUEL 100 (GREEN) OR 100 LL (BLUE)
MINIMUM OCTANE.
50 US GALLONS USABLE
189 LITERS USABLE

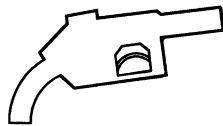

50 GAL
44.5 GAL

TOP
LEFT/RIGHT WINGS
AT FUEL FILLERS
150110-B2008B (WHITE W/BLACK INK)



BLANK



TABLE OF CONTENTS

TITLE	SECTION
INTRODUCTION	3-3
AIRSPEDS FOR EMERGENCY OPERATIONS	3-4
GARMIN G1000 ANNUNCIATOR PANEL WARNING LIGHTS	3-4
ENGINE	3-13
ENGINE POWER LOSS - DURING TAKEOFF ROLL	3-13
ENGINE POWER LOSS - IMMEDIATELY AFTER LIFTOFF (Below 400 Ft AGL)	3-13
ENGINE POWER LOSS - DURING FLIGHT (ABOVE 400 FEET AGL)	3-13
ENGINE POWER LOSS, SUSTAINED NEGATIVE "g" LOADING	3-14
AFTER ENGINE RE- START	3-15
EMERGENCY LANDING WITHOUT ENGINE POWER	3-15
EMERGENCY LANDING WITH THROTTLE STUCK AT IDLE POWER	3-16
PRECAUTIONARY LANDING WITH ENGINE POWER	3-16
POWER LOSS - PRIMARY ENGINE INDUCTION AIR SYSTEM BLOCKAGE	3-16
TURBOCHARGER FAILURE	3-17
TURBOCHARGER OVERBOOST	3-18
ENGINE ROUGHNESS	3-18
HIGH CYLINDER HEAD TEMPERATURE	3-18
HIGH OIL TEMPERATURE	3-18
LOSS OF OIL PRESSURE	3-19
ENGINE DRIVEN FUEL PUMP FAILURE	3-19
FUEL VAPOR SUPPRESSION (FLUCTUATING FUEL FLOW)	3-19
FIRES	3-20
ENGINE FIRE ON GROUND DURING STARTUP	3-20
ENGINE FIRE IN- FLIGHT	3-20
ELECTRICAL FIRE - IN FLIGHT (SMOKE IN CABIN)	3-20
EMERGENCY DESCENT PROCEDURE	3-21
GLIDE	3-22
FORCED LANDING EMERGENCY	3-22
GEAR RETRACTED OR EXTENDED	3-22
OVERWEIGHT LANDING PROCEDURE	3-23
SYSTEMS EMERGENCIES	3-23
PROPELLER OVERSPEED	3-23
ALTERNATOR OVERVOLTAGE	3-23
ALTERNATOR OUTPUT LOW	3-23
ALTERNATOR FAILURE	3-24
AVIONICS EMERGENCIES	3-25
PFD OR MFD DISPLAY FAILURE	3-25
AHRS FAILURE	3-25
AIR DATA COMPUTER (ADC) FAILURE	3-25
ERRONEOUS OR LOSS OF ENGINE AND FUEL DISPLAYS	3-26



TABLE OF CONTENTS (cont'd)

ERRONEOUS OR LOSS OF WARNING/CAUTION ANNUNCIATORS 3-26

LANDING GEAR 3-26

 FAILURE OF LANDING GEAR TO EXTEND ELECTRICALLY 3-26

 FAILURE OF LANDING GEAR TO RETRACT 3-27

 GEAR FAILS TO RETRACT - GEAR WARNING VOICE ALERT SOUNDING 3-27

 WHEN READY TO EXTEND LANDING GEAR 3-27

 GEAR FAILS TO RETRACT - GEAR WARNING VOICE ALERT DOES NOT SOUND 3-27

 WHEN READY TO EXTEND LANDING GEAR AT NEXT LANDING 3-27

OXYGEN 3-27

ALTERNATE STATIC SOURCE 3-27

UNLATCHED DOORS IN FLIGHT 3-28

 CABIN DOORS 3-28

 BAGGAGE DOOR 3-28

ICING 3-28

 INADVERTENT ICING ENCOUNTER 3-28

EMERGENCY EXIT OF AIRCRAFT 3-30

SPINS 3-30

OTHER EMERGENCIES 3-30



INTRODUCTION

This section provides the recommended procedures to follow during adverse flight conditions. The information is presented to enable you to form, in advance, a definite plan of action for coping with the most probable emergency situations which could occur in the operation of your airplane.

As it is not possible to have a procedure for all types of emergencies that may occur, it is the pilot's responsibility to use sound judgement based on experience and knowledge of the aircraft to determine the best course of action. Therefore, it is considered mandatory that the pilot read the entire manual, especially this section before flight.

When applicable, emergency procedures associated with optional equipment such as Autopilots are included in [SECTION IX](#).

-NOTE-

All airspeeds in this section are indicated (IAS) and assume zero instrument error unless stated otherwise.



AIRSPEEDS FOR EMERGENCY OPERATIONS

CONDITION	RECOMMENDED SPEED
ENGINE FAILURE AFTER TAKEOFF	
Wing Flaps UP	85 KIAS
Wing Flaps DOWN	80 KIAS

BEST GLIDE SPEED	
3368 lb./1528 kg	91.5 KIAS
3200 lb./1452 kg	89.0 KIAS
2900 lb./1315 kg	84.5 KIAS
2600 lb./1179 kg	80.0 KIAS

MANEUVERING SPEED	
3368 lb./1528 kg	127 KIAS
3300 lb./1497 kg	126 KIAS
2430 lb./1102 kg	108 KIAS
2232 lb./1012 kg	103 KIAS

PRECAUTIONARY LANDING WITH ENGINE POWER	
Flaps DOWN	75 KIAS

PRECAUTIONARY LANDING ABOVE 3200 LBS	
Flaps DOWN	80 KIAS

EMERGENCY DESCENT (GEAR UP)	
Smooth Air	194 KIAS
Turbulent Air	
3368 lb./1528 kg	127 KIAS
3300 lb./1497 kg	126 KIAS
2430 lb./1102 kg	108 KIAS
2232 lb./1012 kg	103 KIAS

EMERGENCY DESCENT (GEAR DOWN)	
Smooth Air	165 KIAS
Turbulent Air	
3368 lb./1528 kg	127 KIAS
3300 lb./1497 kg	126 KIAS
2430 lb./1102 kg	108 KIAS
2232 lb./1012 kg	103 KIAS

GARMIN G1000 ANNUNCIATIONS AND WARNING LIGHTS

ANNUNCIATION FUNCTION	ANNUNCIATION COLOR	ANNUNCIATION TRIGGER	ACTION WHEN ON	ACTION WHEN OFF
GEAR DOWN	GREEN	GREEN GEAR DOWN DISPLAYED ON G1000	STEADY GREEN "GEAR DOWN"	OFF WHEN GEAR IS UP
GEAR UNSAFE	RED	RED GEAR UNSAFE DISPLAYED ON G1000. DISPLAYS ALSO DURING GEAR TRANSITION	STEADY RED "GEAR UNSAFE"	OFF WHEN GEAR IS UP OR DOWN
LOW MANIFOLD PRESSURE	AMBER	AMBER LOW MAN PRESS DISPLAYED, BELOW 15 IN. ABOVE 12,000 FEET ALTITUDE	STEADY AMBER "LOW MAN PRESS"	OFF WHEN MANIFOLD PRESSURE IS ABOVE 15 IN.



GARMIN G1000 ANNUNCIATIONS AND WARNING LIGHTS - CONT'D

ANNUNCIATION FUNCTION	ANNUNCIATION COLOR	ANNUNCIATION TRIGGER	ACTION WHEN ON	ACTION WHEN OFF
SPEEDBRAKE	WHITE	WHITE SPEED BRAKE DISPLAYED ON G1000.	STEADY WHITE "SPEEDBRAKE"	OFF WHEN SPEEDBRAKES ARE RETRACTED
ALTERNATE AIR	AMBER	AMBER ALTERNATE AIR when ALTERNATE AIR handle is manually pulled out or when Automatically opened (Induction Air system Blockage).	STEADY AMBER "ALTERNATE AIR"	OFF WHEN ALTERNATE AIR HANDLE IS PUSHED IN
PROP DEICE	AMBER	If system is operating properly, the GREEN PROP DEICE switch lamp is illuminated, and the G1000 shows no annunciation. Amber PROP DEICE FAIL if the PROP DEICE switch is in ON position with Green PROP DEICE switch lamp illuminated, but PROP DEICE system has failed. NOTE: PROP DEICE is only an option for aircraft without TKS installed.	STEADY AMBER "PROP DEICE FAIL"	OFF WHEN PROP DEICE SWITCH IS SELECTED OFF
PITOT HEAT	AMBER	If system is operating properly, the GREEN Pitot Heat switch lamp is illuminated, and the G1000 shows no annunciation. AMBER PITOT HEAT FAIL if the PITOT HEAT switch is in ON position with Green PITOT HEAT switch lamp illuminated, but Pitot Heat system has failed.	STEADY AMBER "PITOT HEAT FAIL"	OFF WHEN PITOT HEAT SWITCH IS SELECTED OFF
ALTERNATOR FAIL	RED	RED ALTERNTR FAIL when Alternator output goes to zero, or when Field shorts. NOTE: Voltmeter on MFD Display flashes YELLOW when bus voltage drops below ~@24.5VDC whether alternator has failed or not.	STEADY RED "ALTERNTR FAIL"	OFF WHEN ALTERNATOR OUTPUT IS NORMAL
START POWER	RED	RED START POWER displayed ON when starter is engaged	STEADY RED "START POWER"	OFF WHEN STARTER IS NOT ENGAGED
EMERGENCY BUS	AMBER	AMBER EMERGENCY BUS when EMERGENCY BUS switch is selected ON. Green lamp on Emergency Bus switch when switch is selected ON	STEADY RED "EMERGENCY BUS"	OFF WHEN EMERGENCY BUS NOT ENERGIZED
DOOR OPEN	RED	RED DOOR OPEN Displayed on G1000 when either cabin door(s) or baggage door is not shut.	STEADY RED "DOOR OPEN"	OFF WHEN ALL DOORS ARE SHUT
LOW BOOST PUMP	WHITE	LOW BOOST: GREEN lamp illuminated on LOW BOOST Switch. WHITE low boost illuminated on Annunciation.	STEADY WHITE "LOW BOOST PUMP"	OFF WHEN LOW BOOST PUMP SWITCH IS SELECTED OFF
LOW FUEL RIGHT OR LEFT	AMBER	AMBER when fuel quantity usable is ~10 U.S. Gallons	N/A	N/A
LOW FUEL RIGHT OR LEFT	RED	RED when fuel quantity usable is > 6-8 U.S. Gallons	N/A	N/A
HI BOOST PUMP	AMBER	AMBER HI BOOST Displayed on G1000. NOTE: The HI BOOST switch has a thumb lock-out to prevent accidental operation instead of a green lamp.	STEADY AMBER "HI BOOST PUMP"	OFF when HI BOOST PUMP switch is selected OFF



GARMIN G1000 ANNUNCIATIONS AND WARNING LIGHTS - CONT'D

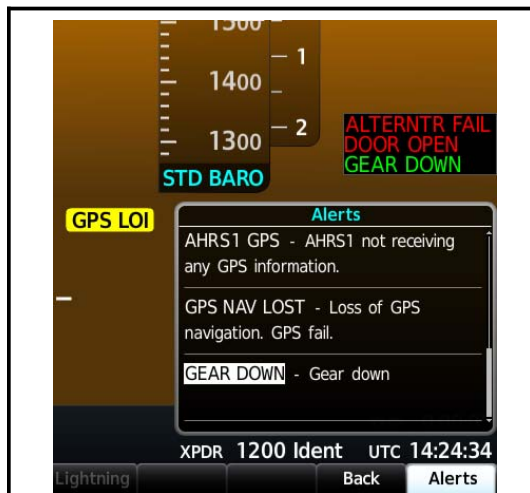

GEAR DOWN - ALERT & ANNUNCIATION



GEAR UNSAFE - MASTER WARNING

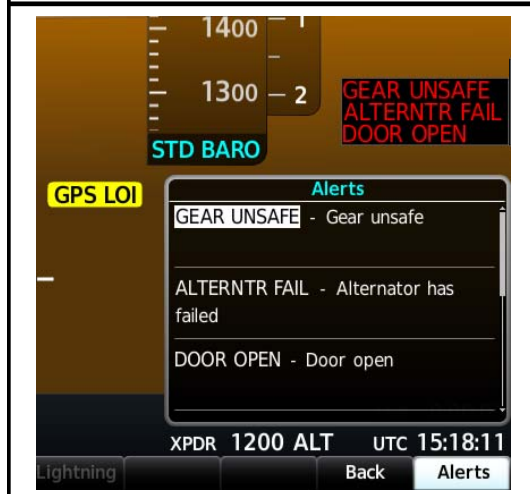

GEAR UNSAFE - ALERT & ANNUNCIATION

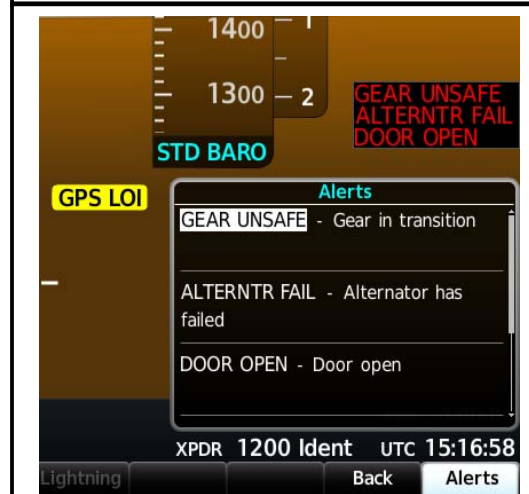

GEAR UNSAFE - ALERT & ANNUNCIATION "IN TRANSITION"



GEAR UNSAFE GEAR DOWN ALERT & ANNUNCIATION

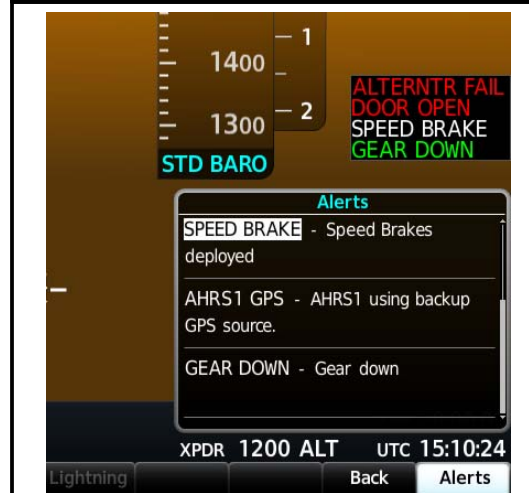

SPEEDBRAKE ALERT & ANNUNCIATION



GARMIN G1000 ANNUNCIATIONS AND WARNING LIGHTS - CONT'D

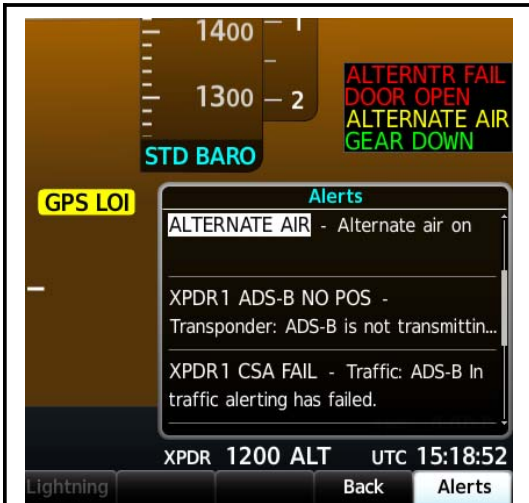

ALTERNATE AIR - ALERT & ANNUNCIATION



ALTERNATE AIR MASTER CAUTION

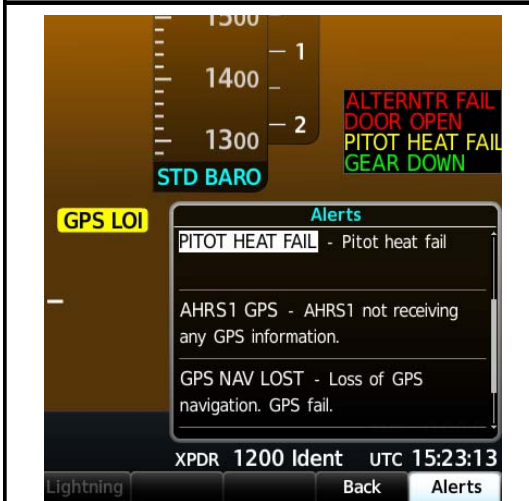

PITOT HEAT FAIL ALERT & ANNUNCIATION



PITOT HEAT FAIL MASTER CAUTION



PROP DE-ICE FAIL MASTER CAUTION

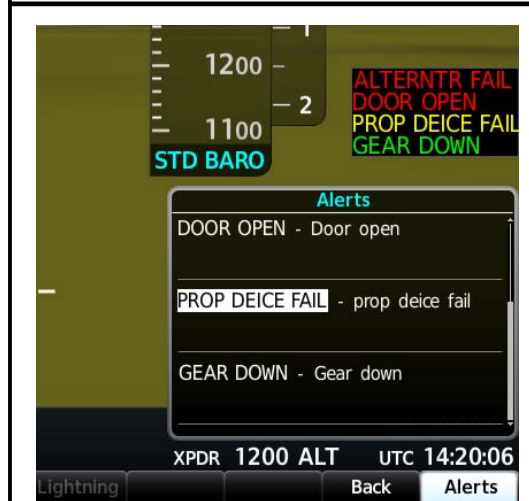

PROP DE-ICE FAIL ALERT & ANNUNCIATION



GARMIN G1000 ANNUNCIATIONS AND WARNING LIGHTS - CONT'D

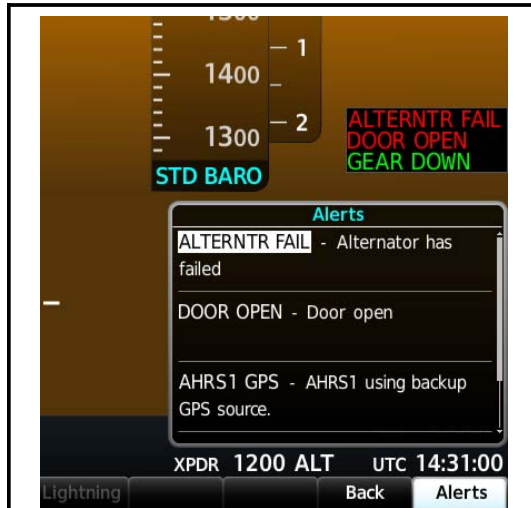

**ALTERNATOR FAIL
ALERT & ANNUNCIATION**



**ALTERNATOR FAIL
MASTER WARNING**

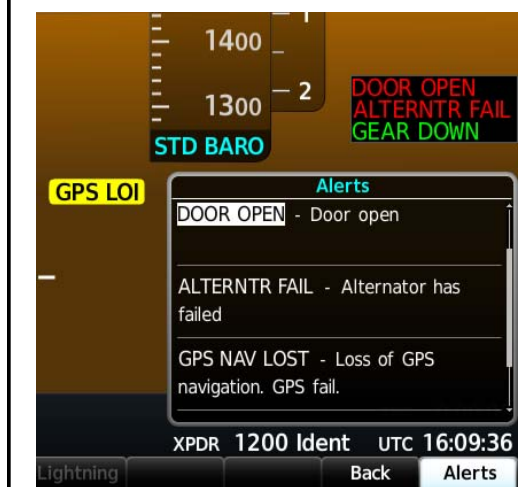

**DOOR OPEN
ALERT & ANNUNCIATION**



DOOR OPEN - MASTER WARNING

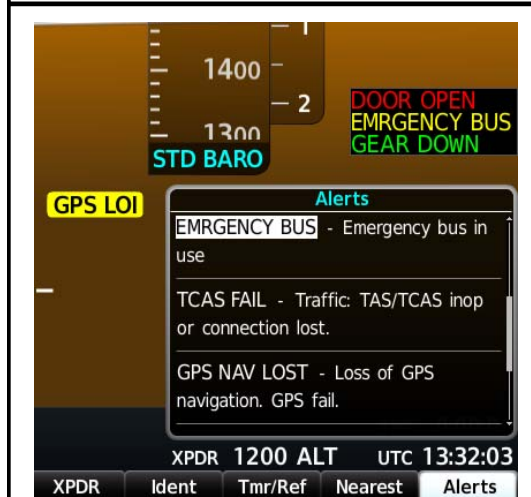

**EMERGENCY BUS
ALERT & ANNUNCIATION**



**EMERGENCY BUS
MASTER CAUTION**



GARMIN G1000 ANNUNCIATIONS AND WARNING LIGHTS - CONT'D



**HIGH BOOST PUMP
ALERT & ANNUNCIATION**



**HIGH BOOST PUMP
MASTER CAUTION**

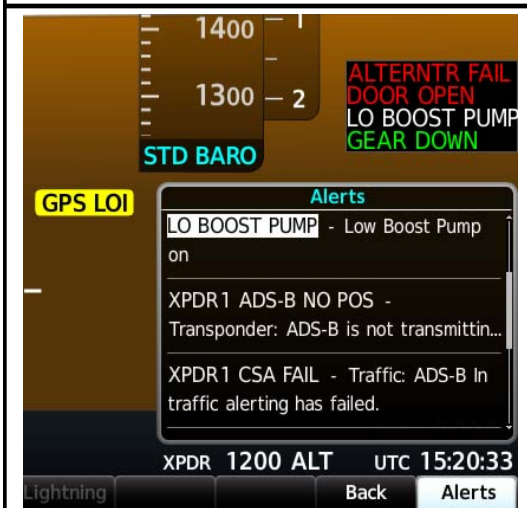

**LOW BOOST PUMP - ALERT
& ANNUNCIATION**

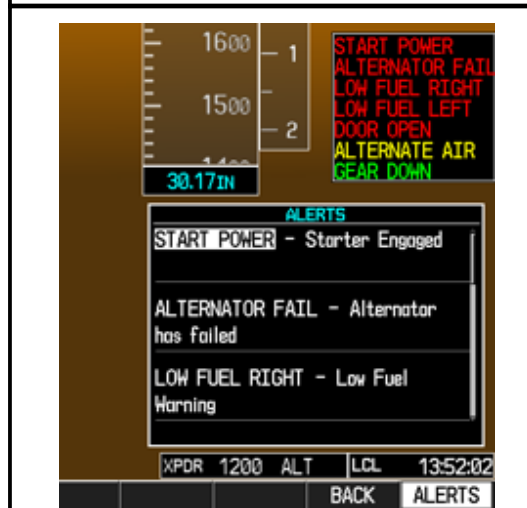

**START POWER - ALERT
& ANNUNCIATION**



**LOW FUEL WARNING - LEFT & RIGHT
MASTER WARNING**

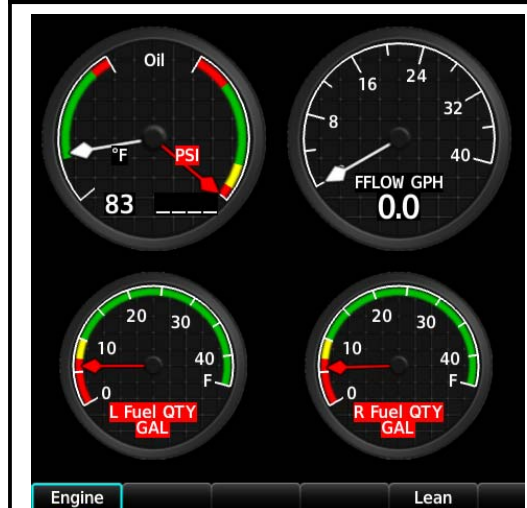

**LOW FUEL WARNING
LEFT & RIGHT GAUGE**



GARMIN G1000 ANNUNCIATIONS AND WARNING LIGHTS - CONT'D

1500 — 1
1400 — 2
STD BARO

LO FUEL LEFT
LO FUEL RIGHT
ALTERNTR FAIL
DOOR OPEN
GEAR DOWN

Alerts

LO FUEL LEFT - Low Fuel Warning

LO FUEL RIGHT - Low Fuel Warning

ALTERNTR FAIL - Alternator has failed

XPDR 1200 Ident UTC 15:44:00

Lightning Back Alerts

**LOW FUEL WARNING - LH & RH
CAS & ALERT**

Oil 83 PSI

FFLOW GPH 0.0

L Fuel QTY GAL

R Fuel QTY GAL

Engine Lean

**LOW FUEL CAUTION
LEFT GAUGE**

1500 — 1
1400 — 2
STD BARO

LO FUEL RIGHT
ALTERNTR FAIL
DOOR OPEN
LO FUEL LEFT
GEAR DOWN

Alerts

LO FUEL LEFT - low fuel caution

AHRS1 GPS - AHRS1 not receiving backup GPS information.

GEAR DOWN - Gear down

XPDR 1200 ALT UTC 15:42:15

Lightning Back Alerts

**LOW FUEL CAUTION - LEFT
CAS & ALERT**

Oil 83 PSI

FFLOW GPH 0.0

L Fuel QTY GAL

R Fuel QTY GAL

Engine Lean

**LOW FUEL CAUTION
RIGHT GAUGE**

1500 — 1
1400 — 2
STD BARO

LO FUEL LEFT
ALTERNTR FAIL
DOOR OPEN
LO FUEL RIGHT
GEAR DOWN

Alerts

LO FUEL RIGHT - Low Fuel Caution

AHRS1 GPS - AHRS1 not receiving backup GPS information.

GEAR DOWN - Gear down

XPDR 1200 ALT UTC 17:49:04

XPDR Ident Tmr/Ref Nearest Alerts

**LOW FUEL CAUTION - RIGHT
CAS & ALERT**

1300 — 1
1200 — 2
29.81 IN

LO FUEL RIGHT
LO FUEL LEFT
ALTERNTR FAIL
DOOR OPEN
GEAR DOWN

GPS LOI

Alerts

XPDR1 ADS-B NO POS -
Transponder: ADS-B is not transmittin...

XPDR1 CSA FAIL - Traffic: ADS-B in traffic alerting has failed.

XPDR1 ADS-B TRFC - Datalink: Traffic failed.

XPDR 1200 ALT UTC 17:32:21

XPDR Ident Tmr/Ref Nearest Alerts

GTX - NO GPS



GARMIN G1000 ANNUNCIATIONS AND WARNING LIGHTS - CONT'D



LRU REPLACEMENT MESSAGE



SYSTEM CONFIG ERROR



TCAS FAIL / DATA PATH FAIL

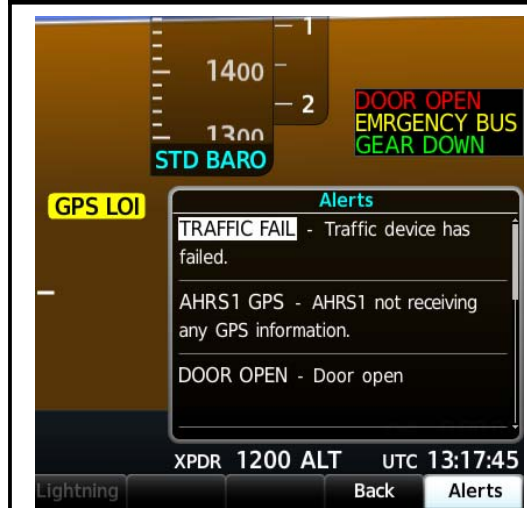

TRAFFIC FAIL



If GARMIN G1000 GPS navigation information is not available or invalid, utilize remaining operational navigation equipment as required.

If the “POSN ERROR” annunciation is displayed the system will flag and no longer provide GPS based navigational guidance. The crew should revert to the G1000 VOR/ILS receivers or an alternate means of navigation other than the G1000 GPS receivers.

If the “POSN ERROR” annunciation is displayed in the enroute, oceanic, terminal, or initial approach phase of flight, continue to navigate using the GPS equipment or revert to an alternate means of navigation other than the G1000 GPS receiver appropriate to the route and phase of flight. When continuing to use GPS navigation, position must be verified every 15 minutes using the G1000 VOR/ILS receiver or another IFR- approved primary navigation system.

-CAUTION-

If the “POSN ERROR” annunciation is displayed while on the final approach segment (between the Final Approach Fix and the Missed Approach Point), GPS based navigation will continue for up to 5 minutes with approach CDI sensitivity set at 0.3 nautical mile. It is recommended that the pilot initiate the missed approach upon receipt of this message from the G1000. Navigation guidance will continue for 5 minutes allowing the pilot to initiate the missed approach while maintaining course guidance on the final approach course. Then the system will flag and no longer provide course guidance with approach sensitivity. Missed approach course guidance may still be available with 1 nautical mile CDI sensitivity by executing the missed approach. This is typically caused by the GPS sensor’s inability to provide adequate horizontal position accuracy for the final approach segment. It is possible, however unlikely, that the GPS position may degrade to the point where terminal operations cannot be supported for the missed approach segment. Navigate using other primary navigation equipment (VOR receivers, etc.) if this occurs.

In an in-flight emergency, depressing and holding the Comm transfer button for 2 seconds will select the emergency frequency of 121.500 MHz, and will show it in the “Active” frequency window.

The Attitude, Heading and Reference System (AHRS) requires at least one GPS or air data input to function properly. In the unlikely event that both GPS position sources fail, and the air data computer fails, the AHRS will subsequently lose attitude and heading and the pilot will be required to use the standby instrumentation. In this instance, the PFD will not provide altitude, airspeed, attitude, or navigation information



ENGINE

ENGINE POWER LOSS - DURING TAKE-OFF ROLL

Throttle SET TO IDLE
Brakes AS REQUIRED TO STOP AIRCRAFT
Mixture SET TO IDLE CUTOFF
Fuel Selector OFF
Magneto Switch OFF

ENGINE POWER LOSS - IMMEDIATELY AFTER LIFTOFF (Below 400 Feet AGL)

Airspeed 85 KIAS (Flaps UP) *
..... 80 KIAS (Flaps DOWN) *

KEEP THE AIRCRAFT UNDER CONTROL - THEN:

Mixture SET TO IDLE CUTOFF
Fuel Selector OFF
Throttle CLOSED
Magneto Switch OFF

Wing Flaps - IN THE LANDING POSITION (If airspeed and height above ground permit full extension of flaps. Otherwise, use maximum flap extension practicable depending on airspeed and height above ground).

* Obtain this airspeed if altitude permits, otherwise lower the nose, maintain current airspeed and land straight ahead.

-WARNING-

If the LOW or HIGH boost pump is in use during an emergency, proper leaning procedures are important. During the descent and approach to landing phases of the flight, DO NOT set the mixture too rich as prescribed in the normal landing procedures, and avoid closing the throttle completely. If a balked landing is necessary, coordinate the simultaneous application of throttle and mixture.

ENGINE POWER LOSS IN FLIGHT (Above 400 Feet AGL)

Airspeed 85 KIAS (Flaps UP)
..... 80 KIAS (Flaps DOWN)
Fuel Selector SELECT FULLEST TANK
Magneto Switch Verify on BOTH
LOW Boost Pump Switch ON
Throttle SET TO HALF OPEN
Propeller FULL FORWARD
Mixture PULL TO CUTOFF THEN GRADUALLY RICHEN UNTIL ENGINE STARTS

If engine does not restart:

Alternate Air Door PULL TO OPEN
LOW Boost Pump OFF
HIGH Boost Pump ON
Mixture PULL TO CUTOFF THEN GRADUALLY RICHEN UNTIL ENGINE STARTS

If engine does not re-start , establish best glide speed (Refer to Maximum Glide Distance Chart) and proceed to **FORCED LANDING EMERGENCY.**

If engine starts:

Engine Temperatures CHECK OIL and CHT within GREEN arc,
..... warm engine at partial power if req'd
Altitude ATTAIN SAFE ALTITUDE
After engine re-start, refer to **AFTER ENGINE RE-START** procedure.



-WARNING-

At altitudes above 18,000 ft., an overrich mixture may result if the turbocharger fails and the engine may stop firing.

-NOTE-

Excessive engine cooling may be experienced during long descents resulting in low engine oil and cylinder head temperatures. This may result in the engine not accelerating properly when power is reapplied. If oil or cylinder head temperatures are excessively low then the engine should be operated at partial power until the temperatures are sufficient for full power operation.

ENGINE POWER LOSS, SUSTAINED NEGATIVE "g" LOADING

-WARNING-

DO NOT INTENTIONALLY OPERATE IN NEGATIVE "g" LOADING.

Per Continental Motors specifications the Model TSIO- 550 series engine is NOT APPROVED for continuous negative or zero "g" operation and operation in that environment is prohibited. Depending on the loading and amount of time encountered (more than normally encountered in gusts) the engine may quit due to low oil pressure. Upon return to positive loading the engine will normally restart on its own but may require some leaning of the mixture at very high altitudes for restart. If negative load conditions are unavoidably encountered, the following procedures are recommended.

Airspeed As required to RECOVER
Attitude Wings LEVEL and UPRIGHT

If engine restarts

Throttle REDUCE POWER to prevent propeller over speed
Attitude Recover to LEVEL FLIGHT
Power Resume NORMAL POWER setting

If a propeller overspeed occurs follow PROPELLER OVERSPEED procedure.

If engine does not re-start within ten (10) seconds, follow ENGINE POWER LOSS IN FLIGHT procedure.



AFTER ENGINE RESTART

HIGH Boost Pump If ON then turn OFF
Alternate Air Door CLOSED (If open)
..... (see Power Loss - Primary Engine Induction Air System Blockage page 3- 12)
Airspeed ADJUST as required
Throttle MINIMUM FOR LEVEL FIGHT AT SAFE SPEED
Failure Analysis DETERMINE CAUSE

Improper Fuel Management - If the engine failure cause is determined to be improper fuel management, set the HIGH boost pump to OFF and resume flight.

Engine Driven Fuel Pump Failure - If fuel management is correct, failure of the engine driven fuel pump or a clogged fuel filter is probable. An engine driven fuel pump failure is probable when engine will only operate with HIGH BOOST pump ON. If practicable, reduce power to 75% or less and land as soon as possible. Do not set the mixture too rich for descent or landing.

Improper Mixture Setting - If fuel management is correct and the engine driven fuel pump is functioning properly, it is possible the mixture is either too lean or too rich.

Possible over rich conditions:

- Very low power settings at high altitude and rich mixture.
- Very low power settings with the fuel boost on and rich mixture.
- Severe induction system blockage, leakage, or turbo failure and rich mixture.

Possible over lean conditions:

- Advancing the throttle or prop from a lean condition before richening.
- HIGH Fuel boost switched off from a lean condition before richening.
- Vapor in fuel line (likely to happen in very hot ambient conditions at altitude).
- High altitude descent in lean condition with no corresponding throttle or mixture change.

EMERGENCY LANDING WITHOUT ENGINE POWER

GLIDE

Airspeed BEST GLIDE SPEED
3368 lb./1528 kg 91.5 KIAS
3200 lb./1452 kg 89.0 KIAS
2900 lb./1315 kg 84.5 KIAS
2600 lb./1179 kg 80.0 KIAS
Propeller PULL FULL AFT
Wing Flaps UP
..... (See Maximum Glide - Distance Chart for best speed)
Radio MAKE DISTRESS TRANSMISSION
Seat Belts/Shoulder Harnesses FASTENED AND SECURE
Loose Objects SECURE
LOW Boost Pump OFF

LANDING

Mixture SET TO IDLE CUTOFF
Fuel Selector OFF
Magneto Switch OFF
Wing Flaps AS REQUIRED (Full Flaps Recommended)
SPEEDBRAKE Switch SET TO OFF/DOWN POSITION
Landing Flare INITIATE AT APPROPRIATE POINT TO ARREST DESCENT RATE AND
..... TOUCHDOWN AT NORMAL LANDING SPEEDS
Braking AS REQUIRED TO STOP AIRCRAFT



EMERGENCY LANDING WITH THROTTLE STUCK AT IDLE POWER

GLIDE

Airspeed	BEST GLIDE SPEED (See MAXIMUM GLIDE DISTANCE Chart)
3368 lb./1528 kg	91.5 KIAS
3200 lb./1452 kg	89.0 KIAS
2900 lb./1315 kg	84.5 KIAS
2600 lb./1179 kg	80.0 KIAS
Propeller	PULL FULL AFT
Wing Flaps	UP
Radio	MAKE DISTRESS TRANSMISSION
Seat Belts/Shoulder Harnesses	FASTENED AND SECURE
Loose Objects	SECURE
LOW Boost Pump	OFF

LANDING

Wing Flaps	AS REQUIRED (Full Flaps Recommended)
Engine Shutdown	DELAY AS LONG AS PRACTICABLE
Landing Flare	INITIATE AT APPROPRIATE POINT TO ARREST DESCENT RATE AND TOUCHDOWN AT NORMAL LANDING SPEEDS
Braking	AS REQUIRED TO STOP AIRCRAFT

PRECAUTIONARY LANDING WITH ENGINE POWER

Seat Belts/Shoulder Harnesses	FASTENED AND SECURE
Loose Objects	SECURE
Wing Flaps	SET TO TAKEOFF POSITION
Airspeed	75 KIAS 80 KIAS (Above 3200 Lbs.)
Select a Landing area	
Wing Flaps	SET TO LANDING POSITION (On Final Approach)
Airspeed	75 KIAS 80 KIAS (Above 3200 Lbs.)
Landing	LAND AS SLOW AS PRACTICABLE - NOSE UP ATTITUDE
Magneto Switch	OFF
LOW Boost Pump	Verify OFF
Braking	AS REQUIRED TO STOP AIRCRAFT

If necessary, use fire extinguisher to keep fire out of cabin area.

POWER LOSS - PRIMARY ENGINE INDUCTION AIR SYSTEM BLOCKAGE

Blockage of the primary engine induction air system may be a result of flying in cloud or heavy snow with cold outside air temperatures (0° C or below). At these temperatures, very small water droplets or solid ice crystals in the air may collect and freeze on the induction air filter causing partial or total blockage of the primary engine induction system.

If primary induction air system blockage occurs, the alternate engine induction air system will automatically open, supplying engine with an alternate air source drawn from inside the cowling rather than through the air filter. The alternate air system can also be manually opened at any time by pulling the control labeled ALTERNATE AIR. Automatic or manual activation of the alternate induction system is displayed in the cockpit by the illumination of the ALT AIR light in the G1000 annunciator panel. When operating on the alternate air system, available engine power will be less for a given propeller RPM compared to the primary induction air system. This is due to loss of ram effect and induction of warmer inlet air.



The following check list should be used if a **partial power loss** due to primary induction air system blockage is experienced:

Alternate Air Verify OPEN (annunciator light ON)
 Manifold Pressure 1 - 2 inches less than normal, due to warm induction air

-NOTE-

The alternate air door should open automatically when primary induction system is restricted. If alternate air door has not opened (Annunciator light- OFF) it can be opened manually by pulling alternate air control.

Throttle INCREASE as desired
 Propeller INCREASE as required
 to maintain desired cruise power setting (Ref. SECTION V)
 Mixture RELEAN to desired EGT
 Flight CONTINUE - request altitude with warmer air, if able

In the unlikely event that a **total power loss**, due to primary engine induction air blockage, is experienced, the following checklist should be used:

Airspeed BEST GLIDE SPEED
 3368 lb./1528 kg 91.5 KIAS
 3200 lb./1452 kg 89.0 KIAS
 2900 lb./1315 kg 84.5 KIAS
 2600 lb./1179 kg 80.0 KIAS
 Alternate Air Manually OPEN
 LOW Boost Pump ON
 Throttle SET TO HALF OPEN
 Propeller FULL FORWARD
 Mixture PULL TO CUTOFF, THEN GRADUALLY RICHEN UNTIL ENGINE STARTS
 Magneto/Starter Switch Verify on BOTH
 After engine re- start:
 Throttle ADJUST as required
 Propeller ADJUST as required
 Mixture RELEAN as required for power setting
 (Refer to power charts - SECTION V)
 LOW Boost Pump OFF

If engine does not re- start after several attempts, maintain best glide speed & proceed to

FORCED LANDING EMERGENCY.

TURBOCHARGER FAILURE

-WARNING-

If turbocharger failure is a result of a loose, disconnected or burned through exhaust, than a serious fire hazard exists. If a failure in the exhaust system is suspected in flight, shut down the engine and LAND AS SOON AS POSSIBLE. If a suspected exhaust system failure occurs before takeoff, DO NOT FLY THE AIRCRAFT.

Turbocharger failure may be evidenced by the inability of the engine to develop manifold air pressure above the ambient pressure. The engine will revert to “normally aspirated” mode and can be operated but will produce less than rated horsepower. If turbocharger failure occurs before takeoff, do not fly the aircraft. If a failure occurs in flight, readjust mixture as necessary to obtain fuel flow appropriate to manifold air pressure and RPM.



An interruption in fuel flow or manifold pressure to the engine will result in turbocharger “run-down”. At high altitude, merely restoring fuel flow may not cause the engine to restart, because without turbocharger boost, the mixture will be excessively rich. If the engine does not fire, there will be insufficient mass flow through the exhaust to turn the turbine. This condition may lead one to suspect a turbocharger failure. Follow the procedures described in **ENGINE POWER LOSS IN FLIGHT (Above 400 Feet AGL)**. Engine starting will be apparent by a surge of power. As the turbocharger begins to operate, manifold pressure will increase and mixture can be adjusted accordingly. If manifold pressure does not increase then the turbocharger has failed. If turbocharger failure is a result of a loose, disconnected or burned through exhaust, then a serious fire hazard exists.

TURBOCHARGER OVERBOOST

If the turbocharger wastegate control fails in the CLOSED position, an engine power overboost condition may occur. The following procedure is recommended for an overboost condition:

Throttle REDUCE as required to keep manifold pressure within limits

ENGINE ROUGHNESS

Engine instruments CHECK
Fuel Selector OTHER TANK
Mixture READJUST for smooth operation
Magneto/Starter Switch Select R or L or BOTH
If roughness disappears on single magneto, monitor power and continue on selected magneto.

The engine may quit completely when one magneto is switched off if the other magneto is faulty. If this happens, close throttle to idle and mixture to idle cutoff before turning magnetos ON to prevent a severe backfire. When magnetos have been turned back ON, proceed to **POWER LOSS - IN FLIGHT**. Severe roughness may be sufficient to cause propeller separation. Do not continue to operate a rough engine unless there is no other alternative.

Throttle REDUCE
..... check for a throttle setting that may cause roughness to decrease

If severe engine roughness cannot be eliminated, **LAND AS SOON AS PRACTICABLE.**

HIGH CYLINDER HEAD TEMPERATURE

Mixture ENRICH As Required
Airspeed INCREASE As Required
Power REDUCE - if temperature cannot be maintained within limits

HIGH OIL TEMPERATURE

-NOTE-

Prolonged high oil temperature indications will usually be accompanied by a drop in oil pressure. If oil pressure remains normal, then a high temperature indication may be caused by a faulty instrument display or thermocouple.

Airspeed INCREASE
Power REDUCE

PREPARE FOR POSSIBLE ENGINE FAILURE IF TEMPERATURE CONTINUES HIGH.



LOSS OF OIL PRESSURE

Oil temperature 170° to 240° F (77° to 104° C)
If Oil Temperature Normal LAND AS SOON AS POSSIBLE

If Oil Temperature Above Normal
Throttle REDUCE to Minimum Power Required
..... LAND AS SOON AS POSSIBLE

BE PREPARED FOR LOSS OF ENGINE POWER AND PREPARE FOR AN EMERGENCY LANDING

ENGINE DRIVEN FUEL PUMP FAILURE

-WARNING-
IF HIGH BOOST PUMP MUST BE LEFT ON TO ACHIEVE NORMAL FUEL FLOW, LAND AS SOON AS PRACTICABLE

-WARNING-
When operating engine at moderate power with “HIGH BOOST” ON and engine driven fuel pump has failed, engine may quit or run rough when manifold pressure is reduced, unless manually leaned.

An engine driven fuel pump failure is probable when engine will only operate with HIGH BOOST pump ON. Operation of engine with a failed engine driven fuel pump and auxiliary fuel pump HIGH BOOST ON will require smooth operation of engine controls and corresponding mixture change when throttle is repositioned or engine speed is changed. When retarding throttle or reducing engine speed, adjust mixture to prevent engine power loss from an overrich condition. Enrich mixture when opening throttle or increasing engine speed to prevent engine power loss from a lean condition. Always lean to obtain a smooth running engine.

The following procedure should be followed when a failed engine driven fuel pump is suspected:

HIGH BOOST Pump ON
Throttle CRUISE Position or as required for engine operation
Mixture ADJUST for smooth engine operation

LAND AS SOON AS PRACTICABLE & CORRECT MALFUNCTION.

FUEL VAPOR SUPPRESSION (Fluctuating Fuel Flow)

LOW Boost Pump ON to clear vapors
Engine operation MONITOR
LOW Boost Pump OFF - (If condition still exists, REPEAT PROCEDURE, LEAVE PUMP ON)



FIRES

-NOTE-

If necessary, use fire extinguisher to keep fire out of cabin area.

ENGINE FIRE - DURING START ON GROUND

Magneto/Starter Switch CONTINUE cranking or until fire is extinguished.
..... If engine starts:

If engine starts:

Power 1500 RPM for several minutes
Engine SHUTDOWN; inspect for damage

If engine does not start:

Magneto/Starter Switch CONTINUE CRANKING
Mixture IDLE CUTOFF
Low Fuel Boost Pump Switch OFF
Throttle FULL FORWARD
Fuel Selector Valve OFF
Magneto/Starter Switch OFF
Master Switch OFF
FIRE EXTINGUISH with Fire Extinguisher

ENGINE FIRE - IN FLIGHT

Fuel Selector Valve OFF
Throttle CLOSED
Mixture IDLE CUT OFF
Magneto/Starter Switch OFF
Cabin Ventilation & Heating Controls CLOSED

ELECTRICAL FIRE - IN FLIGHT (Smoke in Cabin)

If electrical power is essential for the flight, attempt to isolate the faulty circuit.

Cabin Ventilation OPEN
Heating Controls CLOSED
Circuit Breakers CHECK to identify faulty circuit if possible

-NOTE-

If fire is not extinguished, attempt to increase airflow over engine by increasing glide speed. Proceed with **FORCED LANDING EMERGENCY. DO NOT attempt an engine restart.**

LAND AS SOON AS POSSIBLE.

If smoke in the cockpit continues, press the EMERG BUS switch and Pull BATT C/B to shed the non-essential equipment.

-NOTE-

If the autopilot is engaged, the EMERG BUS is activated and the BATT C/B is pulled, it will disengage without annunciation.

-NOTE-

The standby instrumentation will remain powered with the EMERG BUS switch ON.

-NOTE-

The standby instrumentation has an internal battery and will remain powered on in the event of a complete loss of power.



If power must be re-established to navigation equipment to continue flight: If the faulty component can be determined, pull the associated circuit breaker if not tripped already. Do not close the open breaker to re-establish power to the failed circuit.

If the faulty component cannot be determined, pull all essential circuit breakers, switch the Master switch ON and Alternator switch ON; then close circuit breakers one at a time. Permit a short time to elapse before closing the next circuit breaker.

EMERGENCY DESCENT PROCEDURE

In the event an emergency descent from high altitude is required, rates of descent of at least 3,000 feet per minute can be obtained in two different configurations:

1. With landing gear and flaps retracted, an airspeed of 194 KIAS will be required for maximum rate of descent.
2. With the landing gear extended and flaps retracted an airspeed of 164 KIAS will also give approximately the same rate of descent. At 164 KIAS and the gear extended, the angle of descent will be greater, thus resulting in less horizontal distance traveled than a descent at 194 KIAS. Additionally, descent at 164 KIAS will provide a smoother ride and less pilot work load.

THEREFORE; The following procedure is recommended for an emergency descent:

Power RETARD INITIALLY
Airspeed 140 KIAS
Landing Gear EXTEND
Airspeed INCREASE TO 164 KIAS after landing gear is extended
Wing Flaps UP
Airspeed MAINTAIN 164 KIAS during descent.
Speedbrakes (If installed) EXTEND
Altitude AS DESIRED
Power During Descent AS REQUIRED
..... to Maintain CHT 250°F (121° C) Minimum
..... Maximum Continuous 460° F (215.6° C)



MAXIMUM GLIDE DISTANCE MODEL M20V

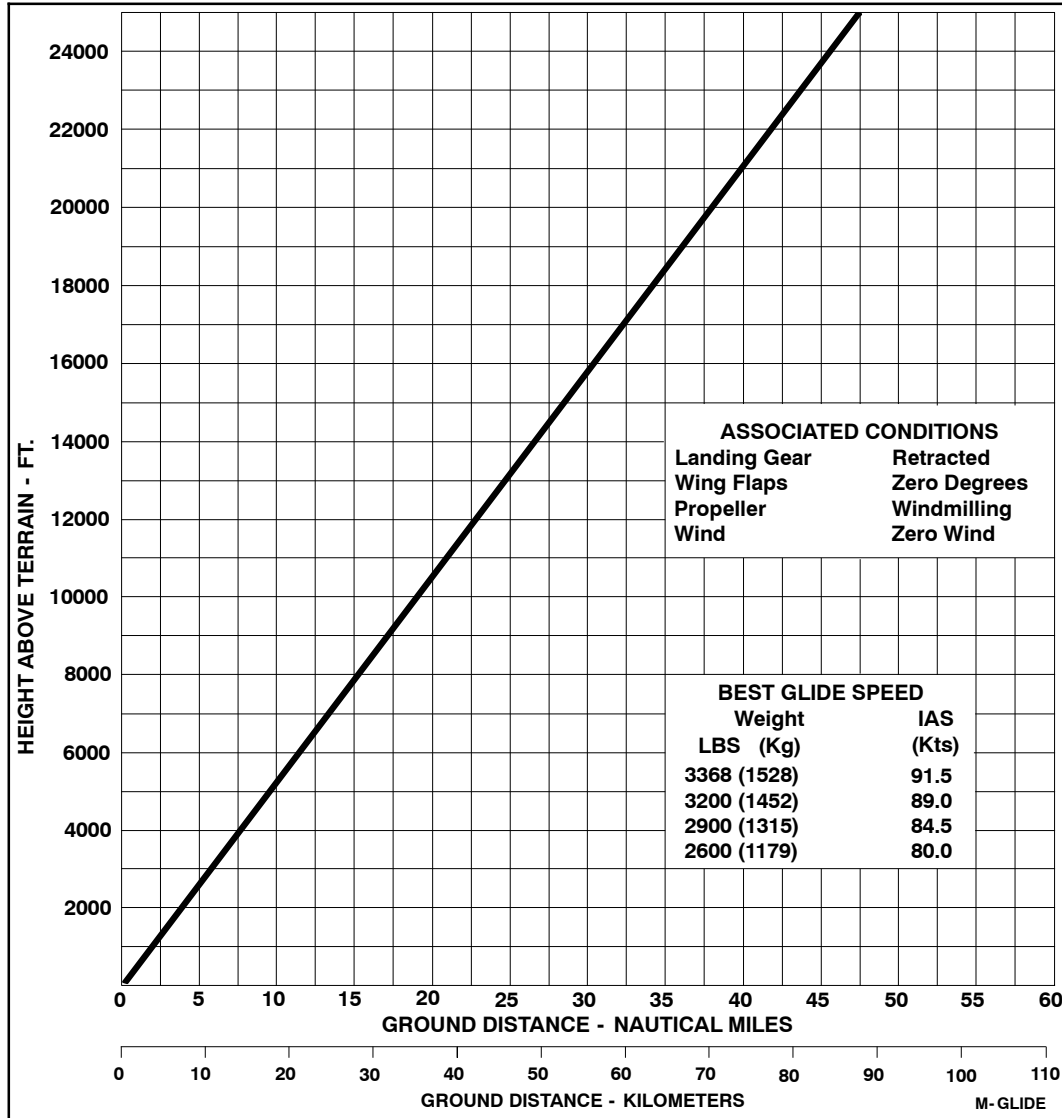

-NOTE-

Greater glide distances can be attained by moving the propeller control FULL AFT (LOW RPM).

FORCED LANDING EMERGENCY

GEAR RETRACTED OR EXTENDED

- Emergency Locator Transmitter ARMED
- Seat Belts/Shoulder Harnesses SECURE
- Cabin Door(s) UNLATCHED
- Fuel Selector OFF
- Mixture IDLE CUTOFF
- Magneto/Starter Switch OFF
- Wing Flaps Full DOWN
- Landing Gear DOWN- If conditions permit
- Approach Speed 80 KIAS
- Master Switch OFF, prior to landing
- Wings LEVEL Attitude



OVERWEIGHT LANDING PROCEDURES

In the event it is necessary to land with weight exceeding 3200 Lbs. (1452 Kg.) (max. landing weight) the following procedure is recommended in addition to normal [APPROACH FOR LANDING](#) procedures:

Approach Airspeed 80 KIAS

Use a flatter approach angle than normal, with power as necessary until a smooth touchdown is assured.

Expect landing distance over a 50 feet obstacle (Ref. [SECTION V](#)) to increase at least 600 ft. Conduct Gear and Tire Servicing inspection as required (Ref. [SECTION VIII](#)).

SYSTEMS EMERGENCIES

PROPELLER OVERSPEED

Throttle RETARD
Oil Pressure CHECK
Propeller DECREASE RPM, re- set if any control available
Airspeed REDUCE
Throttle AS REQUIRED to maintain RPM below 2500 RPM
Record POWER settings, MAX RPM, and duration TIME of overspeed event.

-NOTE-

Refer to Engine and Propeller operating manuals to determine continued airworthiness requirements post-flight.

ALTERNATOR OVERVOLTAGE

(Alternator warning light illuminated “Red” steady and Alternator Field circuit breaker tripped.)

Alternator Field Circuit Breaker RESET
If circuit breaker will not reset, the following procedures are required:

- 1. Reduce electrical load, as required, to maintain essential systems.
- 2. Continue flight and LAND, when PRACTICABLE, to correct malfunction.

-NOTE-

The only source of electrical power is from the selected battery. Monitor battery voltage (min. 18V) and switch to other battery when necessary.

ALTERNATOR OUTPUT LOW

(Alternator annunciator warning light flashing)

Reduce electrical load.

If annunciator light still flashes:

Alternator Field Switch OFF

- 1. Reduce electrical load, as required, to maintain essential systems.
- 2. Continue flight and LAND, when PRACTICABLE, to correct malfunction.

-NOTE-

The only source of electrical power is from the selected battery. Monitor battery voltage (min. 18V) and switch to other battery when necessary.

Battery endurance will depend upon battery condition and electrical load on battery. If one battery becomes depleted, switch to other battery.



ALTERNATOR FAILURE

If the Main Alternator fails, indicated by the Master Warning “ALT VOLTS” flashing:
Perform the Standby Alternator Emergency Checklist (repeated below)

1. Push the “Stdby Alt/Emergency Bus” switch ON. (This activates the emergency bus circuitry & Standby Alternator system) Verify:
 - a.) The AMBER “EMERG BUS” annunciator illuminates, and
 - b.) The RED “ALT VOLTS” flashing annunciator extinguishes.

-NOTE-

The most efficient operating RPM is 2500 RPM when operating on the Standby Alternator System.

2. All electrical systems will remain powered and functional.
3. If the RED “ALT VOLTS” annunciator remains flashing, then:

-CAUTION-

If the RED “ALT VOLTS” annunciation remains flashing, then the standby alternator has failed, and only main battery power remains.

4. Reduce the electrical load by pulling the “BAT” circuit breaker. This load sheds the non-essential bus. The following systems remain powered by the essential bus:

-CAUTION-

If the autopilot is engaged, when the BAT circuit breaker is pulled, the autopilot will disconnect without annunciation.

- ALT SENSE
- EMER ALT BUS
- ALT FIELD
- EMER ALT FIELD
- ALT OUT
- STBY ALT
- BAT
- AUX PANEL
- AUX OVHD
- GLARESHIELD LIGHT
- PFD
- MFD
- AHRS
- ADC
- ENGINE INST
- STBY GYRO
- ICE PROT SYS (If Installed)
- STBY BUS BAT
- COM 1
- NAV 1 / GPS 1
- AUDIO
- XPONDR
- STALL WARN
- ICE LITE (If Installed)
- PITOT HEAT



The following systems on the non-essential bus will be unpowered:

- Com 2
- Nav 2 / GPS 2
- All lighting on the Overhead Panel
- Fuel Pumps
- Autopilot
- Electric Trim
- Landing Gear Motor and Indicators
- Defrost Blower
- DATA LINK
- WX Stormscope (OPTIONAL)
- ADF (OPTIONAL)
- DME (OPTIONAL)
- TRAFFIC ALERT GTS 800 (OPTIONAL)

5. TERMINATE FLIGHT AS SOON AS PRACTICABLE.

6. On approach, the pilot may engage the “BAT” circuit breaker to reestablish power to all systems if necessary.
7. If using battery power only and the primary battery has been depleted (minimum of 18 VDC), the pilot may select the alternate battery using the main battery selection switch. There will be no change in available equipment when changing battery sources. All equipment powered previously will remain powered

AVIONICS EMERGENCIES

PFD OR MFD DISPLAY FAILURE

1. DISPLAY BACKUP button on audio panel PUSH

AHRS FAILURE

-NOTE-

Failure of the Attitude and Heading Reference System (AHRS) is indicated by a removal of the sky/ground presentation and a red X and a yellow “AHRS FAILURE” shown on the PFD. The digital heading presentation will be replaced with a yellow “HDG” and the compass rose digits will be removed. The course pointer will indicate straight up and course may be set using the digital window.

1. Use Standby Attitude Indicator and Magnetic compass.
2. Course Set using digital window

3. LAND AS SOON AS PRACTICABLE.

AIR DATA COMPUTER (ADC) FAILURE

-NOTE-

Complete loss of the Air Data Computer is indicated by a red X and yellow text over the airspeed, altimeter, vertical speed, TAS and OAT displays. Some FMS functions, such as true airspeed and wind calculations, will also be lost.

1. Use Standby Airspeed Indicator and Altimeter
2. **LAND AS SOON AS PRACTICABLE** at a suitable airport



ERRONEOUS OR LOSS OF ENGINE AND FUEL DISPLAYS

-NOTE-

Loss of an engine parameter is indicated by a red X through the data field. Erroneous information may be identified by indications which do not agree with other system information. Erroneous indications may be determined by comparing a display with other displays and other system information.

1. Set power based on throttle lever position, engine noise and speed.
2. Monitor other indications to determine the health of the engine.
3. Use known power settings in the [POH Chapter V](#) for approximate fuel flow values.
4. Use other system information, such as annunciator messages, fuel quantity and flow, to safely complete the flight.

ERRONEOUS OR LOSS OF WARNING/CAUTION ANNUNCIATORS

-NOTE-

Loss of an annunciator may be indicated when engine or fuel displays show an emergency situation and the annunciator is not present. An erroneous annunciator may be identified when an annunciator appears which does not agree with other displays or system information.

1. If an annunciator appears, treat it as if the condition exists. Refer to the [POH/AFM Emergency procedure](#) or the procedures contained in this AFMS.
2. If a display indicates an abnormal condition but no annunciator is present, use other system information, such as engine displays, fuel quantity and flow, to determine if the condition exists. If it cannot be determined that the condition does not exist, treat the situation as if the condition exists. Refer to the [POH/AFM Emergency procedures](#) or the procedures contained in this AFMS.

LANDING GEAR

FAILURE OF LANDING GEAR TO EXTEND ELECTRICALLY

Airspeed 140 KIAS or less
 Landing Gear Actuator Circuit Breaker PULL
 Landing Gear Switch DOWN
 Gear Manual Emergency Extension Mechanism LATCH FORWARD/LEVER BACK
 to engage manual extension mechanism

-NOTE-

Slowly pull “T” handle 1 to 2 inches (2.5 to 5.1 cm.) to rotate clutch mechanism and allow it to engage drive shaft.

T- Handle PULL (12 to 20 times)
 and RETURN until gear is down and locked
 GEAR DOWN light ILLUMINATED; STOP when resistance is felt
 Visual Gear Down Indicator CHECK ALIGNMENT
 by viewing from directly above indicator

-CAUTION-

Continuing to pull on T-Handle, after GEAR DOWN light ILLUMINATES, may bind actuator; electrical retraction MAY NOT be possible until binding is eliminated by ground maintenance. Return lever to normal position and secure with latch. Reset landing gear actuator circuit breaker.

-WARNING-

Do not operate landing gear electrically with manual extension system engaged. Do not fly aircraft until maintenance/inspection is done on landing gear system.



FAILURE OF LANDING GEAR TO RETRACT

AIRSPEED Below 106 KIAS
GEAR Switch UP Position

GEAR FAILS TO RETRACT - GEAR WARNING VOICE ALERT - SOUNDING;

GEAR ANNUNCIATOR LIGHT & GEAR SAFETY BY-PASS LIGHT - **ILLUMINATED**

GEAR SAFETY BY-PASS SWITCH DEPRESS
HOLD until landing gear is fully retracted

“GEAR UNSAFE” and “GEAR DOWN” Lights EXTINGUISHED

“GEAR RELAY” Circuit Breaker. PULL
..... (Gear Warning VOICE ALERT and Gear By Pass light will go OFF)

Check “Air speed Safety Switch” or other malfunction as soon as practicable.

“GEAR RELAY” Circuit Breaker PUSH IN

WHEN READY TO EXTEND LANDING GEAR

Airspeed BELOW 140 KIAS

Gear Relay C/B RESET

Landing Gear Switch DOWN

Gear Down Light ILLUMINATED

-NOTE-

If above procedures do not initiate retraction process, check gear emergency manual extension lever (on floor) for proper position.

GEAR FAILS TO RETRACT - GEAR WARNING VOICE ALERT - DOES NOT SOUND

GEAR ANNUNCIATOR LIGHTS & GEAR BY-PASS LIGHT - **NOT ILLUMINATED**

GEAR EMERGENCY EXTENSION LEVER (on floor) Verify LATCHED in proper position

GEAR ACTUATOR C/B RESET

..... Gear should retract if C/B was tripped

FLIGHT CONTINUE (if desired)

WHEN READY TO EXTEND LANDING GEAR AT NEXT LANDING

AIRSPEED Below 140 KIAS

GEAR SWITCH DOWN Position

If gear will not extend electrically at this time, refer to [FAILURE OF LANDING GEAR TO EXTEND ELECTRICALLY](#) (previous page).

OXYGEN

In the event of oxygen loss above 12,500 ft. return to 12,500 ft as soon as feasible, refer to Information in [SECTION IX](#) also refer to [SECTION X](#) for the physiological characteristics of high altitude flight.

ALTERNATE STATIC SOURCE

The alternate static air source should be used whenever it is suspected that the normal static air sources are blocked. Selecting the alternate static source changes the source of static air for the altimeter, air speed indicator and rate-of-climb from outside of the aircraft to the cabin interior.

When alternate static source is in use, adjust indicated airspeed and altimeter readings according to the appropriate alternate static source airspeed and altimeter calibration tables in [SECTION V](#). The alternate static air source valve is located on the LH side of instrument panel above ignition switch. When the alternate static system source is first opened, there will be an immediate change to VS and ALT indications. The amount of indicated change will vary based on the current airspeed. The ALT indication will change to calibrated levels after the pressure stabilizes. (Refer to Section V for correction charts.) The autopilot will react to these changes if it is engaged in ALT HOLD mode.



-NOTE-

**When using Alternate Static Source, pilot's window and air vents
MUST BE KEPT CLOSED.**

Alternate Static Source PULL ON
Airspeed and Altimeter Readings CHECK Calibration Tables (Ref SECTION V)

UNLATCHED DOORS IN FLIGHT

CABIN DOORS

If cabin door(s) are not properly closed, they may come unlatched in flight and the "DOOR OPEN" annunciation will display. The cabin door(s) will trail in a position approximately 3 inches (7.6 cm.) open, but the flight characteristics of the airplane will not be affected. There will be considerable wind noise; loose objects, in the vicinity of the open cabin door(s), may exit the aircraft. If practicable, secure the door(s) in some manner to prevent it from swinging open during the landing.

LAND AS SOON AS PRACTICABLE by the following procedures:

Air speed 110 TO 120 KIAS
Descent To Maintain Airspeed
Downwind 100 KIAS
Flaps Take Off
Final 90-95 KIAS until Touchdown
Door(s) PULL SHUT AND LATCH

BAGGAGE DOOR

If baggage door is not properly closed, a "DOOR OPEN" annunciation will display, and it may come unlatched in flight. This may occur during or after take off. The door may open to its full open position and then take an intermediate position depending upon speed of aircraft. There will be considerable wind noise; loose objects, in the vicinity of the open door, may exit the aircraft. There is no way to shut and latch door from the inside. Aircraft flight characteristics will not be affected; fly aircraft in normal manner; **LAND AS SOON AS POSSIBLE** and secure baggage door.

Baggage Door latching mechanism VERIFY MECHANISM PROPERLY ENGAGED
..... (inside latching mechanism) then shut from outside aircraft

ICING

-WARNING-

DO NOT OPERATE IN KNOWN ICING CONDITIONS.

The Model M20V is NOT APPROVED for flight into known icing conditions and operation in that environment is prohibited. However, if those conditions are inadvertently encountered or flight into heavy snow is unavoidable, the following procedures are recommended until further icing conditions can be avoided:

INADVERTENT ICING ENCOUNTER

Pitot Heat ON
Propeller De- Ice ON (if installed)
Alternate Static Source ON (if required)
Cabin Heat & Defroster ON
Engine Gauges MONITOR for any engine power reduction

Turn back or change altitude to obtain an outside air temperature less conducive to icing.



Move propeller control to maximum RPM to minimize ice build-up on propeller blades. If ice builds up or sheds unevenly on propeller, vibration will occur. If excessive vibration is noted, momentarily reduce engine speed with propeller control to bottom of GREEN ARC (Lowest RPM), then rapidly move control FULL FORWARD.

-NOTE-

Cycling RPM flexes propeller blades and high RPM increases centrifugal force which improves propeller capability to shed ice.

As ice builds on the airframe, move elevator control fore and aft slightly to break any ice buildup that may have bridged gap between elevator horn and horizontal stabilizer.

Watch for signs of induction air filter blockage due to ice build-up; increase throttle setting to maintain engine power.

-NOTE-

If ice blocks induction air filter, alternate air system will open automatically.

With ice accumulation of $\frac{1}{4}$ inch or more on the airframe, be prepared for a significant increase in aircraft weight and drag. This will result in significantly reduced cruise and climb performance and higher stall speeds. Plan for higher approach speeds requiring higher power settings and longer landing rolls.

-CAUTION-

Stall warning system may be inoperative.

-NOTE-

The defroster may not clear ice from windshield. If necessary open pilot's storm window for visibility in landing approach and touchdown.

With ice accumulations of 1 inch or less, use no more than 10° wing flaps for approach and landing. For ice accumulation of 1 inch or more, fly approaches and landing with flaps retracted to maintain better pitch control. Fly approach speed at least 15 knots faster than normal, expect a higher stall speed, resulting in higher touchdown speed with longer landing roll. Use normal flare and touchdown technique.

Missed approaches **SHOULD BE AVOIDED** whenever possible because of severely reduced climb performance. If a go-around is mandatory, apply full power, retract landing gear when obstacles are cleared; maintain 90 KIAS and retract wing flaps.

AVOID FURTHER ICING CONDITIONS



EMERGENCY EXIT OF AIRCRAFT

CABIN DOORS LH/RH

PULL latch handle UP.
PUSH OPEN door and exit aircraft.

BAGGAGE COMPARTMENT DOOR (Auxiliary Exit)

Release (Pull UP) rear seat back latches on spar.
Fold rear seat backs forward, CLIMB OVER.
PULL off plastic cover from over inside latch.
PULL lock pin.
Pull red handle.
OPEN door and exit aircraft.
To **VERIFY RE- ENGAGEMENT** of baggage door, outside, latch mechanism:
Open outside handle fully.
Close inside RED handle to engage pin into cam slide of latch mechanism.
Place lock pin in shaft hole to hold RED handle DOWN.
Replace cover.
CHECK & operate outside handle in normal manner.

SPINS

-WARNING-

*Up to 2,000 ft. altitude may be lost in a one turn spin and recovery;
STALLS AT LOW ALTITUDE ARE EXTREMELY CRITICAL.*

-NOTE-

The best spin avoidance technique is to avoid flight conditions conducive to spin entry. Low speed flight near stall should be approached with caution and excessive flight control movements in this flight regime should be avoided. Should an unintentional stall occur, the aircraft should not be allowed to progress into a deep stall. Fast, but smooth stall recovery will minimize the risk of progressing into a spin. If an unusual post stall attitude develops and results in a spin, quick application of anti-spin procedures should shorten the recovery.

INTENTIONAL SPINS ARE PROHIBITED

In the event of an inadvertent spin, the following recovery procedure should be used:

Throttle RETARD to IDLE
Ailerons NEUTRAL
Rudder Apply FULL RUDDER opposite direction of spin
Control Wheel FORWARD of neutral in a brisk motion

ADDITIONAL FORWARD elevator control may be required if rotation does not stop.

HOLD ANTI- SPIN CONTROLS UNTIL ROTATION STOPS

Wing Flaps (If extended) RETRACT as soon as possible
Rudder NEUTRALIZE when spin stops
Control Wheel SMOOTHLY MOVE AFT
..... to bring the nose up to level flight attitude

OTHER EMERGENCIES

Refer to [Section IX](#) for Emergency Procedures of Optional Equipment.



TABLE OF CONTENTS

TITLE	SECTION
INTRODUCTION	4-3
SPEEDS FOR NORMAL OPERATION	4-4
PRE-FLIGHT INSPECTION	4-5
BEFORE STARTING CHECK	4-8
ENGINE START	4-9
NORMAL ENGINE START	4-9
HOT ENGINE START	4-9
FLOODED ENGINE START	4-9
EXTREME COLD WEATHER ENGINE START	4-10
AFTER ENGINE START	4-10
BEFORE TAXI	4-10
Standby Alternator Preflight Check	4-10
Oxygen System	4-10
Standby Alternator Checks Complete	4-10
TAXI	4-10
MINOR SPARK PLUG FOULING	4-11
BEFORE TAKEOFF	4-12
TAKEOFF	4-13
TAKEOFF (NORMAL)	4-13
TAKEOFF (SHORT FIELD)	4-13
CLIMB	4-14
CLIMB (CRUISE)	4-14
CLIMB (BEST RATE Vy)	4-14
CLIMB (BEST RATE Vx)	4-14
CRUISE	4-14
FUEL TANK SELECTION	4-15
DESCENT	4-15
NORMAL DESCENT - GEAR UP	4-16
NORMAL DESCENT - GEAR DOWN	4-16
APPROACH FOR LANDING	4-16
GO AROUND (BALKED LANDING)	4-17
LANDING	4-17
TAXI AFTER LANDING	4-17
SHUTDOWN	4-17
SECURING AIRCRAFT	4-18



BLANK



INTRODUCTION

This section describes the recommended procedures for the conduct of normal operations for the airplane. All of the required (FAA or ICAO regulations) procedures and those necessary for operation of the airplane as determined by the operating and design features of the airplane are presented.

These procedures are provided to present a source of reference and review and to supply information on procedures which are the same for all aircraft. Pilots should familiarize themselves with the procedures given in this section in order to become proficient in the normal operations of the airplane.

Normal procedures associated with those optional systems and equipment which require handbook supplements are provided by [SECTION IX](#) (Supplemental Data).



SPEEDS FOR NORMAL OPERATION

Unless otherwise noted, the following speeds are based on a weight of 3368 pounds and may be used for any lesser weight. However, to achieve the performance specified in [SECTION V](#) for take off distance and climb performance, the speed appropriate to the particular weight must be used.

TAKEOFF:

Normal Climb Out 80-90 KIAS
Short Field Takeoff, Speed At 50 Ft. 75 KIAS

ENROUTE CLIMB, GEAR and FLAPS UP:

Best Rate of Climb 104 KIAS
Best Angle of Climb 85 KIAS

LANDING APPROACH (3200 lbs.):

Normal Approach, Flaps 10 degrees 80 KIAS
Normal Approach, Flaps 33 degrees 75 KIAS
Short Field Approach, Flaps 33 degrees 70 KIAS

BALKED LANDING (3200 lbs.):

Maximum Power, Flaps 10 degrees 85 KIAS

MAXIMUM RECOMMENDED TURBULENT AIR PENETRATION SPEED:

3368 lbs./1528 Kg. 127 KIAS
3200 lbs./1452 Kg. 123 KIAS
2900 lbs./1315 Kg. 117 KIAS
2600 lbs./1179 Kg. 111 KIAS
2400 lbs./1089 Kg. 106 KIAS

DEMONSTRATED CROSSWIND VELOCITY:

Takeoff or Landing 18 Knots
..... (This is NOT A LIMITATION, only a demonstrated number)
..... (See [CROSSWIND COMPONENT CHART, SECTION V](#))



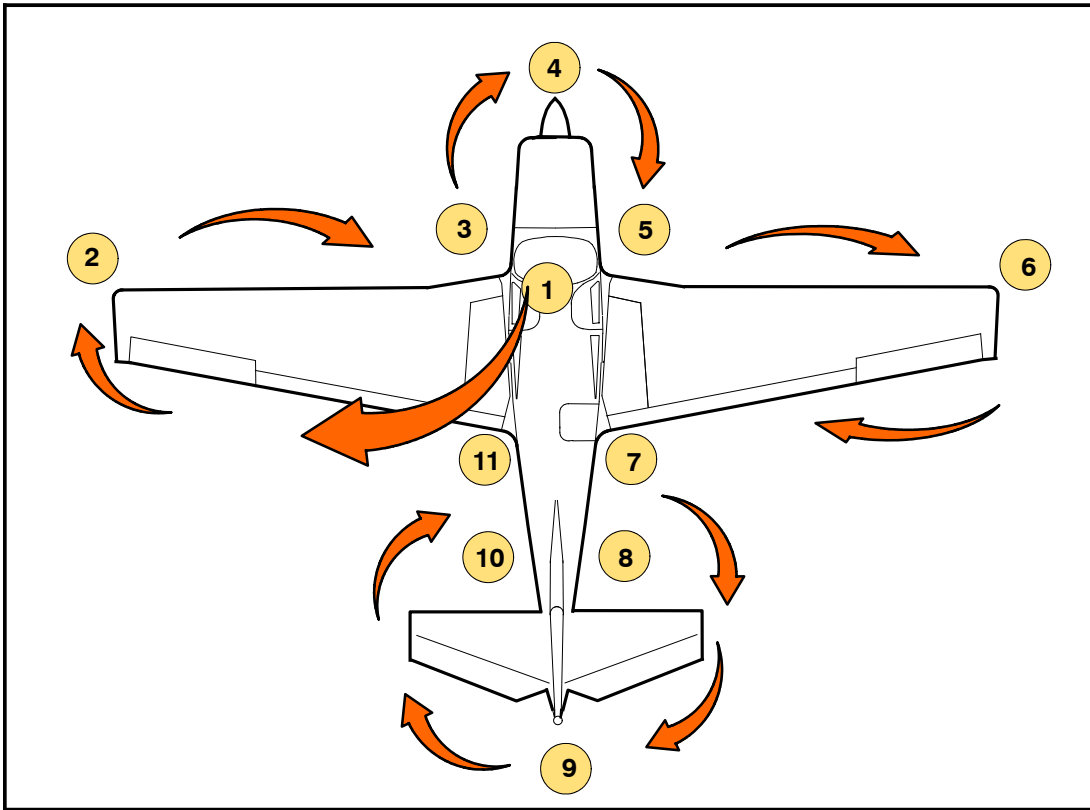

PRE-FLIGHT INSPECTION

1. Cockpit

- POH/Documentation Available
- Weight & Balance CHECK
- Gear Switch DOWN
- Magneto/Starter Switch OFF
- All Rocker Switches OFF
- Master Switch ON
- All Circuit Breakers IN
- Battery Select Switch SELECT from: 1 to 2 - or- 2 to 1
 CHECK Voltmeter after each selection. Leave on Battery with highest voltage
- Internal/External Lights CHECK operation
 Check for ammeter fluctuations as each light is checked
- Pitot Heat Switch ON
 Check Pitot Heat annunciator light illuminated Green on Switch *
- Fuel Quantity Gauges CHECK QTY
- Master Switch OFF
- Pilot Window OPEN
- Fuel Selector
 - It is recommended that wing tank sumps be drained prior to draining gascolator.
 Rt. Tank: Pull Gascolator ring (5 seconds)
 Lt. Tank: Pull Gascolator ring (5 seconds)
- Oxygen Supply Control Knob (if installed) OFF
- Oxygen Pressure Gauge CHECK
- Fire Extinguisher CHARGED



Verify adequate oxygen supply for trip, (if use of oxygen is anticipated), refer to oxygen duration chart, found in the POH/AFM Supplement Section IX
Also check that face masks and hoses are accessible and in good condition

* If TKS system is installed, pitot heat annunciation will illuminate AMBER when Pitot Heat has failed.

2. Left Wing

General Skin Condition INSPECT- Remove ice, snow, or frost
Wing Flap & attach points INSPECT
Aileron & attach points INSPECT
Control linkages INSPECT
Wing Tip, Lights and Lens INSPECT
Fuel Tank Vent UNOBSTRUCTED
Master Switch ON (reach through pilots window)
Pitot Tube UNOBSTRUCTED/SECURED
..... Heat element Operative
Landing/Taxi Lights INSPECT Lens & Bulbs
Stall Switch Vane CHECK operation
Master Switch OFF (reach through pilots window)
Fuel Tank CHECK QUANTITY/SECURE CAP

-NOTE-

**The optional visual fuel quantity gauge is to be used for partial refueling purposes only;
DO NOT use for preflight quantity check.**

Tiedown Rope/Chain REMOVE
Wheel Chock REMOVE
Left Main Landing Gear, Shock Discs, Tire & Doors INSPECT
Fuel Tank Sump Drain DRAIN
..... Use sampler cup to VERIFY fuel is free of water, sediment & other contamination
..... VERIFY proper fuel (BLUE/100LL) (GREEN/100 octane)

-CAUTION-
Some diesel may be BLUE, Verify by smell and feel that 100LL is being used.

..... VERIFY drain closes and does not leak
Pitot System Drain PUSH plunger UP (Hold for 3- 5 seconds)

3. Left Cowl Area

Windshield CLEAN
Cabin Air Inlet UNOBSTRUCTED
Left Side Engine Cowl Fasteners SECURED
Exhaust Pipes INSPECT SECURED
Engine Oil Filler Door OPEN & INSPECT AREA

-NOTE-

The engine compartment must be free of foreign objects which could result in possible overheating and serious damage to the engine.

Engine Oil CHECK QUANTITY
..... 8 Qts. (7.57 L.)
Engine Oil Filler Door CLOSE & SECURE
Cooling Air Inlet Verify UNOBSTRUCTED

4. Propeller/Spinner & Front Cowl Area

Propeller/Spinner INSPECT for nicks, cracks,



..... oil leaks/rotational movement
Prop De- Ice Boots (if installed) INSPECT condition
Induction Air Inlet/Filter UNOBSTRUCTED
Nose Gear, Shock Discs, Tire & Doors INSPECT
Wheel Chock REMOVE

5. Right Cowl Area

Right Side Engine Cowl Fasteners SECURED
Cooling Air Inlet Verify UNOBSTRUCTED
Windshield CLEAN
Cabin Air Inlet UNOBSTRUCTED

6. Right Wing

Fuel Tank Sump Drain DRAIN
..... Use sampler cup to VERIFY fuel is free of water, sediment & other contamination
..... VERIFY proper fuel (BLUE/100LL) (GREEN/100 octane)
..... SEE CAUTION on diesel fuel on previous page
..... VERIFY drain closes and does not leak
Right Main Gear, Shock Discs, Tire & Doors INSPECT
Wheel Chock REMOVE
General Skin Condition INSPECT Remove ice, snow and frost
Fuel Tank CHECK QUANTITY/SECURE CAP

-NOTE-

**The optional visual fuel quantity gauge is to be used for partial refueling purposes only;
DO NOT use for preflight quantity check.**

Tiedown Rope/Chain REMOVE
Fuel Tank Vent UNOBSTRUCTED
Landing/Taxi Lights INSPECT Lens & Bulbs
Wing Tip, Lights and Lens INSPECT
Aileron and Attach Points INSPECT
Wing Flap and Attach Points INSPECT
Control Linkages INSPECT

7. Baggage Door Area

Baggage Door VERIFY SECURED
..... VERIFY inside handle is properly secured
..... CHECK outside handle operation

8. Right Fuselage/Tailcone

Oxygen Filler Access Door and Filler Cap SECURED
Battery #2 Access Panel SECURED
Instrument Static Pressure Port UNOBSTRUCTED
General Skin Condition INSPECT
Tailcone/Empennage Access Panel SECURED
Tail Tiedown Rope/Chain REMOVE

9. Empennage

Elevator and rudder attach points and control linkage attachments INSPECT
Empennage Freeplay- Vertical/Horizontal INSPECT
General Skin Condition INSPECT
..... Remove ice, snow, or frost

10. Left Fuselage/Tailcone

Cabin Fresh Air Vent (Dorsal Fin) UNOBSTRUCTED
Tailcone/Empennage Access Panel SECURED
Instrument Static Pressure Port UNOBSTRUCTED



Avionics/Battery #1 Access Panel SECURED
Auxiliary Power Plug Access Door SECURED
Static System Drain PUSH Plunger UP, (Hold 3-5 Seconds)
General Skin Condition INSPECT

11. Return to Cockpit

Master/Rocker Switches OFF

BEFORE STARTING CHECK

Preflight Inspection Complete
Seats, Seat belts, Shoulder Harness (1 occupant per restraint) Adjust and Secured *
Magneto/Starter Switch OFF
Master Switch ON
Alternator Field Switch OFF
Fuel Boost Pump Switches OFF
Circuit Breakers Check- All In
Rocker Switches OFF
Alternate Static Source Push OFF
Throttle Closed
Propeller Full Forward (High RPM)
Mixture Idle Cut OFF
Brakes Set
Wing Flap Switch Flaps Up
Defrost Push OFF
Cabin Heat Push OFF
Cabin Vent As Desired
Fuel Selector Fullest Tank
Landing Gear Switch Down Position
Red Emergency Gear Extension Handle Down and Latched
Internal Lights OFF
Brief all pilots, and passengers on Warning's, Caution's, Note's, and
general use and wearing of the Oxygen components DONE
Oxygen System Refer to [Section IX](#) for Supplemental Information

Refer to [SECTION IX](#) - Supplemental Data for other Optional Equipment Procedures and Checks.



ENGINE START

-CAUTION-

When either battery voltage is low, inspection should be conducted to determine condition of battery and/or reason for battery being low. Replacement or servicing of batteries is essential and charging for at least one hour should be done before engine is started. Batteries must be serviceable and IT IS RECOMMENDED THAT BATTERIES BE FULLY CHARGED TO OPERATE AIRCRAFT. Electrical components may also be damaged if aircraft is operated when batteries are low.

-NOTE-

When starting engine using the approved external power source, no special starting procedure is necessary. Use normal starting procedures below. **DO NOT START ENGINE IF BOTH BATTERIES ARE INCAPABLE OF STARTING ENGINE.** Recharge dead batteries for at least one hour (at 3 - 4 amps) before starting engine. Only No. 1 battery (left side of tailcone) is connected to the Auxiliary Power plug.

NORMAL ENGINE START

Before Starting Check List COMPLETED
Mixture FULL RICH
Throttle FULL OPEN
Prime the Engine SWITCH HIGH BOOST ON 2 SECONDS
Throttle Control CLOSED THEN OPEN 1/8 TO 1/4 INCH
Check Propeller Area CLEAR
Ignition Switch TURN and PUSH TO START

-CAUTION-

If no oil pressure is noted within 30 seconds, shut down the engine and investigate the cause. Operating the engine without oil pressure may result in engine damage or malfunction.

HOT ENGINE START

Before Starting Check List COMPLETED
Mixture IDLE CUT OFF
Propeller FULL FWD (High RPM)
Throttle Control SET TO CLOSED
Fuel Boost Pump HIGH for 5 SEC (or LOW for 25 SEC) THEN SET TO OFF
Engine Start follow NORMAL procedures

FLOODED ENGINE START

Before Starting Check List COMPLETED
Mixture IDLE CUTOFF
Throttle Control 1/2 OPEN
Ignition Switch TURN and PUSH TO START
Mixture slowly advance toward RICH until engine starts



EXTREME COLD WEATHER ENGINE START

Refer to Continental Motors Engine Operating Manual OI- 18 Section 7.5.1 for extreme cold weather starting procedures.

-CAUTION-

For engine operation at outside air temperatures below -25°C (-13°F), the engine and engine oil should be preheated to at least -25°C (-13°F) before the engine is started.

-NOTE-

“START POWER” warning light should illuminate when Magneto/Starter switch is in “START” position.

-NOTE-

Cranking should be limited to 30 seconds, and several minutes allowed between cranking periods to permit the starter to cool. Never engage starter while the propeller is still turning.

AFTER ENGINE START

Throttle Control ADJUST IDLE (900 to 1000 RPM)
Oil Pressure CHECK for 30 TO 100 PSI
Alternator field switch ON
Ammeter CHECK (Verify annunciator alternator light is OFF and the system is charging)
Position and Anti- collision Lights SET AS REQUIRED
Radios and Required Avionics SET AS REQUIRED

BEFORE TAXI

Engine Start Checklist Completed
Elevator Trim Switch ON
Internal/External Lights As Desired
PFD/MFD Check Normal Operation
Comm/Nav Radios Checked and Set
Altimeter Set
Fuel Selector Switch Tanks, verify engine runs on other tank
Cabin Heat As Desired
Defroster As Desired
Cabin Vent As Desired

-WARNING-

Do not load a new arrival or departure procedure in the flight plan if one currently exists without first removing the existing arrival or departure procedure. Failing to observe this limitation can cause erroneous course deviation indications, loss of GPS navigation information, and other display anomalies.

-NOTE-

If display anomalies are noted after editing the flight plan, perform either a direct to or activate leg operation as appropriate on the flight plan to ensure correct flight plan sequencing and guidance.

Flight Plan As Desired
Optional Equipment Checks Reference Section IX

TAXI

Before Taxi Checklist Completed
Rudder Trim As Desired



-CAUTION-

With Rudder Trim in the full right position the aircraft will tend to steer to the right during taxi.

Parking Brake Release
Brakes Check during taxi
Heading Indicator Proper Indication During Turns
PFD/MFD No Flags/Red X's
Throttle Minimum Power
Propeller Full Forward (High RPM)

-CAUTION-

To prevent battery depletion in prolonged taxi or holding position before takeoff, increase RPM until the "AMPS" indication on the G1000 indicates a positive number.

-WARNING-

The absence of RPM drop when checking magneto function may be an indication of a malfunction in the ignition circuit resulting in a hot magneto (not grounding properly). Should the propeller be moved by hand, the engine may start and cause death or injury. This type of malfunction must be corrected before operating the engine.

-CAUTION-

Do not disregard the importance of pre-takeoff magneto checks. When operating on a single ignition some RPM drop should always occur. Normal indications are 25 to 75 RPM and a slight engine roughness as each magneto is switched OFF. A drop in excess of 150 RPM may indicate a faulty magneto or fouled spark plugs.

-WARNING-

Continuous overboost operation may damage the engine and require engine inspection.

MINOR SPARK PLUG FOULING

Minor spark plug fouling may be cleared by:

Brakes HOLD MANUALLY
Throttle SET TO 2200 RPM
Mixture ADJUST FOR MAXIMUM PERFORMANCE
..... Move Towards Idle Cutoff Until RPM Peaks
..... Hold For 10 Seconds
..... Return To Full Rich
Throttle SET TO 1700 RPM
Magnetos RECHECK (50 RPM Difference With Max. Drop Of 150 RPM)
Throttle SET TO IDLE (900 to 1000 RPM)

-CAUTION-

Do not operate engine at a speed of more than 2000 RPM longer than necessary to test engine operations and observe engine instruments. Proper engine cooling depends on forward speed. Discontinue testing if temperature or pressure limits are approached.

-WARNING-

Continuous overboost operation may damage the engine and require engine inspection.



BEFORE TAKEOFF

Taxi Checklist Complete
 Parking Brake Set
 Fuel Selector Fullest Tank
 Engine Runup OIL TEMPERATURE CHECK ABOVE 100°F
 Throttle 1700 RPM
 Magneto Switch L POSITION
 (25 RPM drop minimum, 150 RPM drop max., EGTs should rise)
 Magneto Switch R POSITION
 (25 RPM drop minimum, 150 RPM drop max.
 50 RPM difference between L and R, EGTs will rise)
 Magneto Switch BOTH (EGTs should drop)
 Propeller CHECK OPERATION (Cycle from high to low RPM two to three times)
 Engine Instruments CHECK
 Annunciator TEST
 Throttle SET TO IDLE

Standby Alternator Preflight Check

(Will Not Show A Charge Until Approximately 2000 rpm)

Alt Field Switch OFF
 Verify red ALT VOLTS light illuminates
 Stdbby Alt/Emerg Bus switch ON
 Verify amber Emerg Bus light illuminates
 Pull BATT Circuit Breaker
 Verify positive charge on battery ammeter
 Verify red ALT VOLTS light extinguishes
 Reset BATT Circuit Breaker
 Stdbby Alt/Emerg Bus switch OFF
 Verify red ALT VOLTS light illuminates
 Alt Field Switch ON
 Verify red ALT VOLTS light extinguishes

If Oxygen is Required or Preferred, Refer to Supplemental Information in Section IX

Standby Alternator Checks Complete

Ammeter CHECK positive charge indication
 Main Battery Voltage Greater than 26.5VDC
 Select the other battery using the BAT 1/2 selector
 Ammeter CHECK Positive Charge Indication
 Main Battery Voltage Greater than 26.5VDC
 Select desired Main Battery for use during flight using BAT 1/2 selector
 Elevator Trim TAKEOFF SETTING
 Rudder Trim TAKEOFF SETTING
 Wing Flaps CHECK operation
 SET AT TAKEOFF POSITION (10 degrees)
 Flight Controls CHECK free and correct movement
 Cabin Doors CHECK SECURED
 Seats, Seat Belts and Shoulder Harness SECURED
 Avionics and Autopilot CHECK – (Refer to Section IX)
 G1000 Annunciation(s) CHECK
 Internal/External Lights AS DESIRED
 Strobe Lights ON
 Pilots Window CLOSED
 Emergency Gear Extension (RED) Handle DOWN and LATCHED
 Parking Brake RELEASE



TAKEOFF

Proper engine operation should be checked early in the takeoff roll. Any significant indication of rough or sluggish engine response is reason to discontinue takeoff. When takeoff must be made over a gravel surface, it is important that the throttle be applied SLOWLY. This will allow the aircraft to start rolling before high RPM is developed, and gravel or loose material will be blown back from the propeller area instead of being pulled into it.

TAKEOFF (NORMAL)

Mixture FULL RICH
Power ADVANCE SLOWLY TO FULL RPM (2500 RPM)
..... (Watch manifold pressure, adjust throttle as required to avoid overboost)
Annunciator CHECK
Engine Instruments CHECK for proper indications
Lift Off/Climb Speed As specified in [SECTION V](#) (Takeoff Distance)
Landing Gear RETRACT IN CLIMB after clearing obstacles
Wing Flaps UP

TAKEOFF (SHORT FIELD) - Complete BEFORE TAKEOFF Checklist First

Wing Flaps TAKEOFF POSITION
Brakes APPLY
Throttle FULL (2500 RPM)
Mixture FULL RICH
LOW Boost Pump ON
Brakes RELEASE
Lift Off/Climb Speed As specified in [SECTION V](#) (Takeoff Distance)
Landing Gear RETRACT IN CLIMB after clearing obstacles
Wing Flaps UP



CLIMB

-NOTE-

If applicable, use noise abatement procedures as required. See Section V, for rate of climb graph.

CLIMB (CRUISE)

Airspeed 120 KIAS
Throttle FULL
Propeller 2500 RPM
Mixture FULL RICH (1350°F to 1450°TIT)
LOW Boost Pump ON for vapor suppression above 12,000 ft. or if TIT is
..... rising above 1450°F

CLIMB (BEST RATE, Vy)

Airspeed 104 KIAS
Throttle FULL
Propeller 2500 RPM
Mixture FULL RICH (1350°F to 1450°TIT)
LOW Boost Pump ON for vapor suppression above 12,000 ft. or if TIT is
..... rising above 1450°F

CLIMB (BEST ANGLE, Vx)

Airspeed 85 KIAS
Throttle FULL
Propeller 2500 RPM
Mixture FULL RICH (1350°F to 1450°TIT)
LOW Boost Pump ON for vapor suppression above 12,000 ft. or if TIT is
..... rising above 1450°F

-NOTE-

Leaning may be required during CLIMB depending on atmospheric conditions.

CRUISE

Airspeed ACCELERATE to cruise airspeed
Throttle SELECT setting
Propeller SELECT setting
Mixture LEAN AS REQUIRED (observe limits, see CAUTION below)
..... 50°F Rich of Peak for Best Power
..... 50°F Lean of Peak for Best Economy
LOW Boost Pump OFF below 18,000 ft, leave ON above 18,000 ft
Temperatures CHECK within limits until stabilized
Mixture RE- ADJUST if required

-NOTE-

Refer to cruise performance charts in Section V for power settings.

-CAUTION-

Above 12,000 ft the minimum manifold pressure is 15 in. Hg and the minimum RPM is 2,000. Do not pull the throttle back to idle without leaning mixture appropriately above 12,000 ft. The lack of manifold pressure at altitude without leaning will cause an over-rich condition. This condition may cause the engine to quit above 18,000 ft. This condition may also cause the engine to quit when the throttle is suddenly increased. If it does quit, it is possible to re-start the engine at any altitude by leaning the mixture.



-CAUTION-

Above 30.5 inHg of manifold pressure only full rich mixture is permitted. At altitudes above 22,000 feet, power settings above 2300 rpm must be operated at 1675°F TIT or richer.

-CAUTION-

When changing power, the sequence control usage is important. Monitor the TIT display to avoid exceeding 1750 °F limit. To increase power, first increase the mixture (not necessarily to FULL RICH), then increase RPM with the propeller control and then increase manifold pressure with the throttle control. To decrease power, decrease manifold pressure first with the throttle control and then decrease RPM with the propeller control. When engine temperatures have stabilized, lean mixture to desired TIT.

FUEL TANK SELECTION

LOW Boost Pump ON
 Fuel Selector OPPOSITE TANK
 LOW Boost Pump OFF

DESCENT

-CAUTION-

Above 12,000 ft the minimum manifold pressure is 15 in. Hg and the minimum RPM is 2,200. Do not pull the throttle back to idle without leaning mixture appropriately above 12,000 ft. The lack of manifold pressure at altitude without leaning will cause an over-rich condition. This condition may cause the engine to quit above 18,000 ft. This condition may also cause the engine to quit when the throttle is suddenly increased. If it does quit, it is possible to re-start the engine at any altitude by leaning the mixture.

-NOTE-

Avoid extended descents at low manifold pressure setting, as engine can cool excessively and may not accelerate satisfactorily when power is re-applied.

NORMAL DESCENT - GEAR UP

Seats, Seat Belts/Shoulder Harness ADJUST AND SECURE
 Wing Flaps UP
 Landing Gear UP
 Power Settings AS REQUIRED
 Mixture MOVE TO RICHER SETTING AS REQUIRED
 LOW Boost Pump OFF Below 18,000 Ft.
 Airspeed AS DESIRED (194 KIAS max.)
 Rudder Trim AS DESIRED

-NOTE-

Refer to descent planning charts in [Section V](#) for recommended power settings.

-CAUTION-

DO NOT fly in YELLOW BAR speed range unless the air is smooth.



NORMAL DESCENT - GEAR DOWN

Seats, Seat Belts/Shoulder Harness	ADJUST AND SECURE
Wing Flaps	UP
Power Settings	2400 RPM and approximately 25 inches Hg
Airspeed	140 KIAS or less
Landing Gear	DOWN
Airspeed	164 KIAS or less
Power Settings	AS REQUIRED
Mixture	AS REQUIRED
LOW Boost Pump	OFF Below 18,000 Ft.
Rudder Trim	AS DESIRED

-NOTE-

Using landing gear as a descent aid will result in a steeper descent rate for a given power setting and airspeed. Alternatively, for a fixed descent rate more power will be required. This can be helpful for maintaining minimum oil and cylinder head temperatures. Plan for additional fuel consumption accordingly.

APPROACH FOR LANDING

-CAUTION-

The airplane must be within allowable weight and balance envelope for landing (REF. SECTION VI). It will require a minimum of one hour of flight before a permissible landing weight is attained when takeoffs are made at maximum gross weight. If landing at a weight exceeding maximum landing weight (3200 Lbs.) (1452 Kgs.) is required, see [OVERWEIGHT LANDING PROCEDURE, SECTION III](#).

Seats, Seat Belts/Shoulder Harness	ADJUST AND SECURE
Internal/External lights	AS DESIRED
Landing Gear	EXTEND below 140 KIAS
.....	(Check Gear Down light ON- Check visual indicator)
Mixture	FULL RICH (on final)
Propeller	HIGH RPM (on final)
Fuel Boost Pump Switches	OFF
Fuel Selector	FULLEST TANK
Wing Flaps (below 110 KIAS in all extended positions)	T/O POSITION
.....	(FULL DOWN)

-CAUTION-

To minimize control wheel forces when entering landing configuration, timely nose-up trimming is recommended to counteract nose down pitching moment caused by reduction of power and/or extension of flaps.

Elevator Trim	AS DESIRED
Rudder Trim	AS DESIRED
Parking Brake	VERIFY OFF

-NOTE-

The parking brake should be rechecked to preclude partially applied brakes during touchdown.



GO AROUND (BALKED LANDING)

-CAUTION-

To minimize control wheel forces during GO-AROUND, timely nose-down trimming is recommended to counteract nose up pitching moment as power is increased and/or flaps are retracted.

Power	FULL FORWARD/2500 RPM
Mixture	Verify FULL RICH
LOW Boost Pump	OFF
Wing Flaps	TAKEOFF POSITION (10°)
.....	After POSITIVE climb established:
Trim	NOSE DOWN to reduce forces
Airspeed	85 KIAS
Landing Gear	RETRACT
Wing Flaps	RETRACT
Airspeed	105 KIAS

LANDING

LANDING (NORMAL)

Approach for Landing Check list	COMPLETED
Approach Airspeed	As specified in SECTION V (Landing Distance)
Touchdown	MAIN WHEELS FIRST (aligned w/runway)
Landing Roll	LOWER nose wheel gently
Brakes	MINIMUM required

TAXI AFTER LANDING

Throttle	AS REQUIRED
Fuel Boost Pump Switches	OFF
Wing Flaps	RETRACT
Elevator Trim	TAKEOFF SETTING
Avionics/Radios	AS REQUIRED
Interior/Exterior Lights	AS DESIRED

SHUTDOWN

Parking Brake	SET
Throttle	IDLE 900 RPM
Interior/Exterior Lights	OFF
Pitot Heat	OFF
Magneto/Starter Switch	GROUNDING CHECK
Mixture	IDLE Cut- OFF
Alternator Field Switch	OFF
Master Switch	OFF
Magneto/Starter Switch	OFF

-CAUTION-

Allow the engine to idle at 900 RPM for 5 minutes before shutdown in order to cool the turbochargers. Taxi time can be counted as cooling time.



SECURING AIRCRAFT

- Magneto/Starter Switch VERIFY OFF/key removed
- Master Switch VERIFY OFF
- Electrical Switches VERIFY OFF
- Interior Light Switches VERIFY OFF
- Emergency Bus Switch VERIFY OFF
- Parking Brake RELEASE – Install wheel chocks
- Extended Parking Control Wheel Secured
- Cabin Windows and Doors Closed and Locked

**TIE DOWN AIRCRAFT
at wing and tail points**

Refer to **GROUND HANDLING** - POH Section VIII for proper procedure



TABLE OF CONTENTS

TITLE	SECTION
INTRODUCTION	5-2
VARIABLES	5-2
OPERATIONAL PROCEDURES FOR MAXIMUM FUEL EFFICIENCY	
BEST POWER	5-2
BEST ECONOMY	5-3
PERFORMANCE CONSIDERATIONS	5-3
GENERAL	5-3
OXYGEN SYSTEM	5-3
AIRSPEED INDICATION	5-8
REMOVABLE STEPS	5-8
LANDING GEAR DOORS	5-8
RANGE ADJUSTMENT	5-8

- TABLES AND CHARTS -

TEMPERATURE CONVERSION	5-5
CROSSWIND COMPONENT CHART	5-6
AIRSPEED CALIBRATION - PRIMARY STATIC SYS (POWER ON, CLEAN)	5-7
AIRSPEED CALIBRATION - PRIMARY STATIC SYS (POWER OFF, CLEAN)	5-8
AIRSPEED CALIBRATION - PRIMARY STATIC SYS (POWER ON, 10° GR DWN)	5-9
AIRSPEED CALIBRATION - PRIMARY STATIC SYS (POWER OFF, 10° GR DWN) ..	5-10
AIRSPEED CALIBRATION - PRIMARY STATIC SYS (POWER ON, 33° GR DWN) ...	5-11
AIRSPEED CALIBRATION - PRIMARY STATIC SYS (POWER OFF, 33° GR DWN) ..	5-12
AIRSPEED CALIBRATION - ALTERNATE STATIC SYSTEM	5-13
ALTIMETER CORRECTION - PRIMARY STATIC SYSTEM	5-14
ALTIMETER CORRECTION - ALTERNATE STATIC SYSTEM	5-15
STALL SPEED VS ANGLE OF BANK	5-16
TAKEOFF:	
GROUND ROLL	5-17
OVER 50' OBSTACLE	5-18
CLIMB RATE AT Vy	5-19
CLIMB RATE AT 120 KIAS (CRUISE CLIMB)	5-20
TIME - FUEL - DISTANCE (TO CLIMB - AT Vy)	5-21
TIME - FUEL - DISTANCE (TO CLIMB - AT 120 KIAS)	5-22
CRUISE POWER SETTINGS AND FUEL FLOWS	
BEST POWER	5-23
BEST ECONOMY	5-24
SPEED POWER VS ALTITUDE	
BEST POWER	5-25
BEST ECONOMY	5-32
RANGE AND ENDURANCE - (89 GAL - Best Power and Best Economy)	5-39
RANGE AND ENDURANCE - (100 GAL - Best Power and Best Economy)	5-54
TIME - FUEL - DISTANCE to DESCEND (Maintain 500 fpm Rate of Descent)	5-69
TIME- FUEL- DISTANCE to DESCEND (Maintain 1000 fpm Rate of Descent)	5-70
LANDING:	
GROUND ROLL	5-71
OVER 50' OBSTACLE	5-72



INTRODUCTION

The purpose of this section is to present the owner or operator with information needed to facilitate planning of flights with reasonable accuracy.

The Performance Data and charts presented herein are calculated, based on actual flight tests in dry air, with the airplane and engine in good condition and the engine power control system properly adjusted.

The flight test data has been corrected to International Standard Atmosphere conditions and then expanded analytically to cover various airplane gross weights, operating altitudes, and outside air temperatures.

VARIABLES

It is not possible to make allowances in the charts for varying levels of pilot technique, proficiency or environmental conditions. Mechanical or aerodynamic changes are not authorized because they can affect the performance or flight characteristics of the airplane. The effect of such things as soft runways, sloped runways, winds aloft or airplane configuration changes must be evaluated by the pilot. However, the performance on the charts can be duplicated by following the stated procedures in a properly maintained MOONEY M20V.

Examples are given to show how each chart is used. The only charts with no example are those where such an example of use would be repetitive.

To obtain effect of altitude and OAT on aircraft performance:

1. Set altimeter to 29.92 and read "pressure altitude".
2. Using the OAT grid for the applicable chart read the corresponding effect of OAT on performance.

-CAUTION-

Be sure to return to local altimeter setting in calculating aircraft elevation above sea level.

OPERATIONAL PROCEDURES FOR MAXIMUM FUEL EFFICIENCY

Fuel efficiency (best defined as nmi/gal of fuel) is dependent on the proper use of the mixture control. There are two recommended cruise settings for the TSIO-550-G () engine described in the following paragraphs. At all times engine limitations need to be observed.

Best Power – The Best Power setting will develop the maximum horsepower and speed for a particular manifold pressure and RPM setting. Best Power mixture is desirable for minimizing flight time when fuel burn rate or range is not a primary concern. When TIT limitations prevent attaining peak TIT then best power is obtained at 1650°F TIT.

Best Power Procedure – Upon attaining level flight at cruise altitude set the manifold pressure and RPM as desired not exceeding 30.5 inHg. Slowly move the mixture control toward lean while observing TIT indicator and maintaining TIT limits. If manifold pressure changes while leaning readjust throttle and continue leaning until peak TIT is attained. Note peak TIT and slowly richen mixture until TIT indication is 50°F RICH OF PEAK. Re-adjust throttle or RPM as required.



Best Economy – Best Economy mixture is desirable for maximizing range and minimizing fuel cost. Best Economy is operated 50°F lean of peak TIT. The engine may be leaned up to 100°F lean of peak however the fuel economy generally doesn't improve beyond 50°F lean of peak. Lean of peak operation is dependent on all cylinders running at nearly equal EGT. The first cylinder to reach an over lean condition will cause the engine to run rough. If at anytime during lean of peak operation the engine begins to run rough the pilot should immediately richen the mixture. If a smooth running engine cannot be attained at 50°F lean of peak maintenance action will be required to restore balanced fuel flow to the cylinders and the pilot should choose an alternate mixture setting and revise the flight plan accordingly. The pilot must follow the proper order for changing the power settings (noted below and in SECTION IV) when transitioning back to rich operation or a higher power setting.

Best Economy Procedure – Upon attaining level flight at cruise altitude set the manifold pressure and RPM as desired not exceeding 30.5 inHg. Slowly move the mixture control toward lean while observing TIT indicator and maintaining TIT limits. If manifold pressure changes while leaning readjust throttle and continue leaning until peak TIT is attained. Note peak TIT and slowly lean mixture until TIT indication is 50°F LEAN OF PEAK. Re-adjust throttle or RPM as required.

-CAUTION-

Above 30.5 inHg of manifold pressure only full rich mixture is permitted. At altitudes above 22,000 feet, power settings above 2300 rpm must be operated at 1675°F TIT or richer.

-CAUTION-

When changing power, the sequence of control usage is important. Monitor the TIT display to avoid exceeding 1750°F limit. To increase power, first increase the mixture (not necessarily to FULL RICH), then increase RPM with the propeller control and then increase manifold pressure with the throttle control. To decrease power, decrease manifold pressure first with the throttle control and then decrease RPM with the propeller control. When engine temperatures have stabilized, lean mixture to desired TIT.

PERFORMANCE CONSIDERATIONS

GENERAL

The cruise speed tables herein were established on a standard configuration M20V with an air-speed boom installed. The standard configuration includes the airframe, standard paint job, sanded walkway, Acclaim wingtips, flap seals, cowl exit vanes, standard antennae, standard lights, and low drag nose gear doors. The standard configuration does not include De-icing or Air-Conditioning provisions.

OXYGEN SYSTEM (Refer to [Supplemental Information Section IX](#))



TRUE AIRSPEED INDICATION

True airspeed indication is included on the instrument panel as an aid to the pilot. This true airspeed indication is based on the conversion of indicated airspeed (KIAS) with zero instrument error not calibrated airspeed (KCAS). For this reason the true airspeed indication will normally be a few knots low at typical cruise speeds. A true airspeed calibration for the Power On, Clean Configuration based on the primary static system calibration of this manual is given below for convenience. Actual calibration of both the airframe static system and airspeed indicators can vary slightly from aircraft to aircraft.

True airspeed indicator correction table; standard temperature day Power on, clean configuration						
Pressure Altitude, ft						
KIAS	0	5,000	10,000	15,000	20,000	25,000
Increase KTAS by:						
110	1.0	1.1	1.2	1.3	1.4	1.5
120	1.1	1.2	1.3	1.4	1.5	1.7
130	1.3	1.4	1.5	1.6	1.7	1.9
140	1.4	1.5	1.6	1.8	1.9	2.1
150	1.6	1.7	1.8	1.9	2.1	2.3
160	1.7	1.8	2.0	2.1	2.3	2.5
170	1.8	2.0	2.1	2.3	2.5	2.6
180	2.0	2.1	2.3	2.4	2.6	2.8
190	2.1	2.3	2.4	2.6	2.8	3.0
Add 2% of correction for each 10°C above standard temperature						
Subtract 2% of correction for each 10°C below standard temperature						
Example: 160 KIAS, ISA+20°C, 25000' correction = 2.5 + 0.04 * 2.5 = 2.6 KTAS						

REMOVABLE STEPS

The cruise speed tables herein were established with the aircraft step removed. Aircraft equipped with a removable step may have it removed or installed by a mechanic. If the step is installed decrease the true airspeed at normal cruise power setting by approximately 1–2 KTAS.

LANDING GEAR DOORS

When snow and ice are likely to be present on taxi and runway surfaces, inboard landing gear doors should be removed. Accumulation of ice and snow could prevent landing gear operation. If inboard landing gear doors are removed, a decrease in cruise speed and range can be expected and should be considered in preflight planning. To be conservative the following figures should be used:

Decrease of true airspeed at normal cruise power setting by approximately 5 KTAS.

RANGE ADJUSTMENT

An approximate adjustment to range data shown in this manual can be made based on flight time planned with speed adjustment. For example, using the gear door cruise speed decrease for a 5 hour flight will result in a decrease in range of approximately 25 N.M.:

5 HR X 5 KTS = 25 N.M. reduction in range.

-CAUTION-

Zero wind conditions seldom occur. In addition, varying atmospheric conditions, aircraft weight, mechanical condition of the aircraft and piloting techniques all affect the actual flight time and fuel used during a flight.

It is the pilot's responsibility to determine the actual operating conditions and plan the flight accordingly.



TEMPERATURE CONVERSION

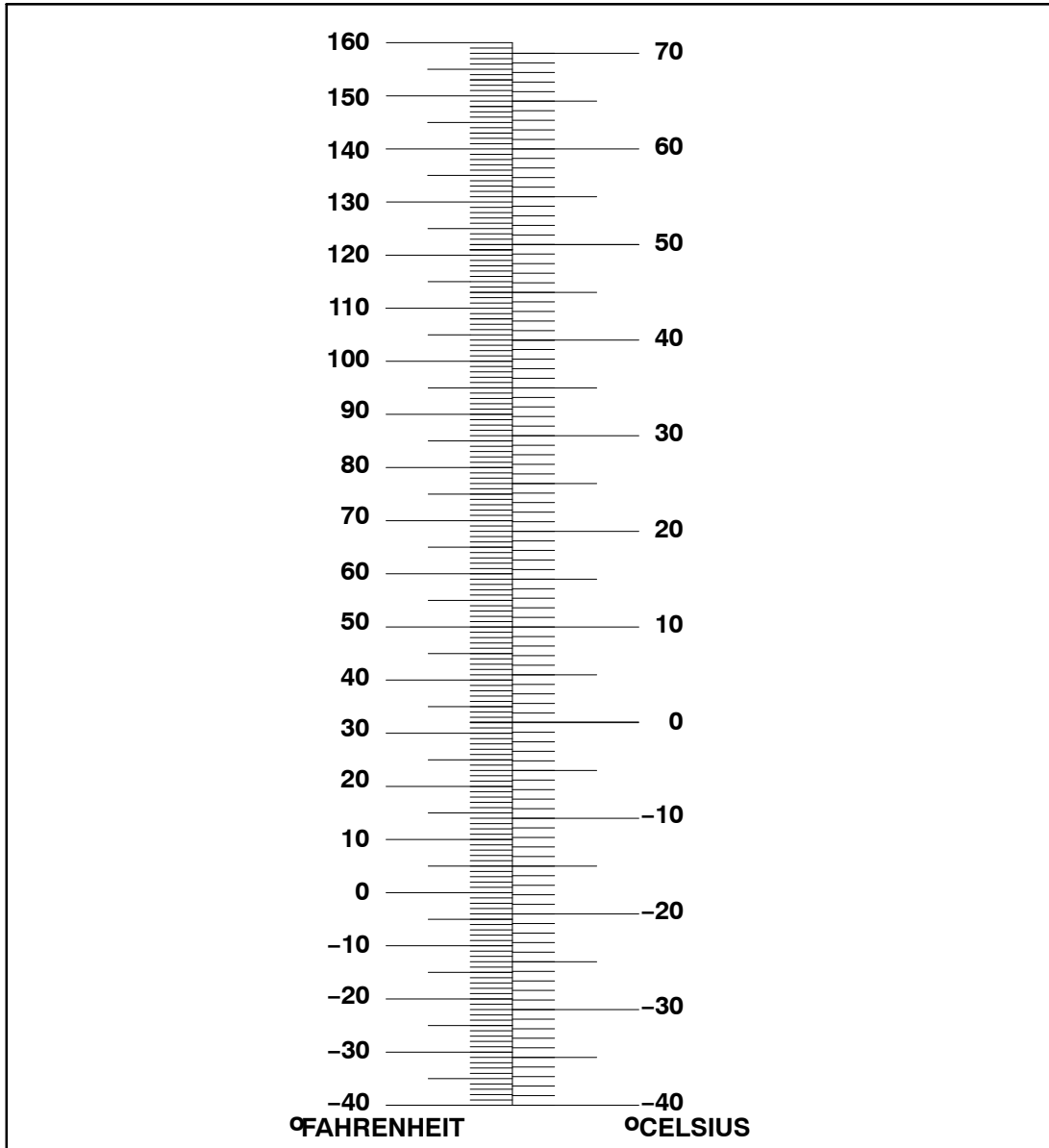

CROSSWIND COMPONENT CHART
DEMONSTRATED CROSS WIND IS 18 KNOTS (THIS IS NOT A LIMITATION)

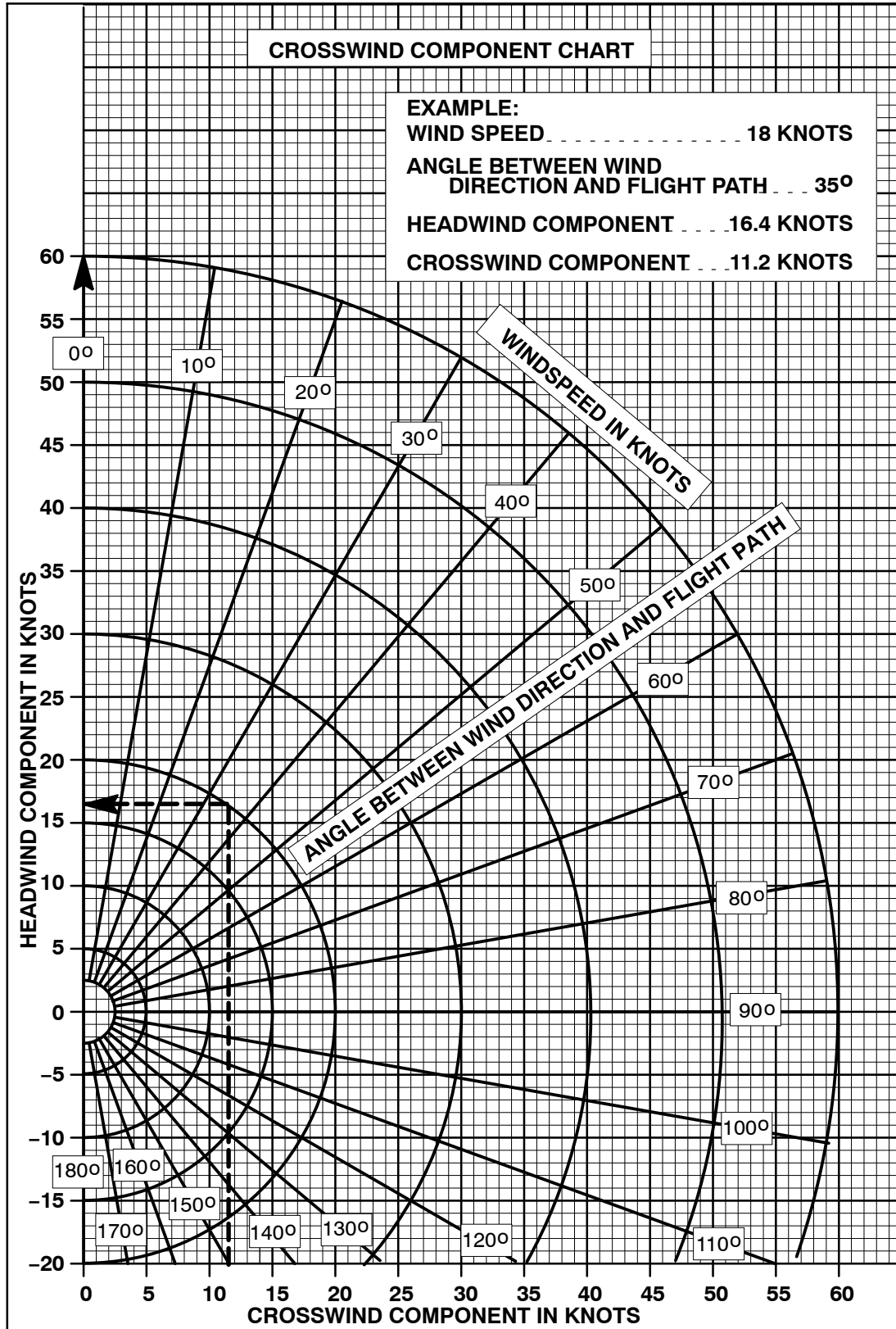

AIRSPEED CALIBRATION – PRIMARY STATIC SYSTEM
POWER ON, CLEAN CONFIGURATION

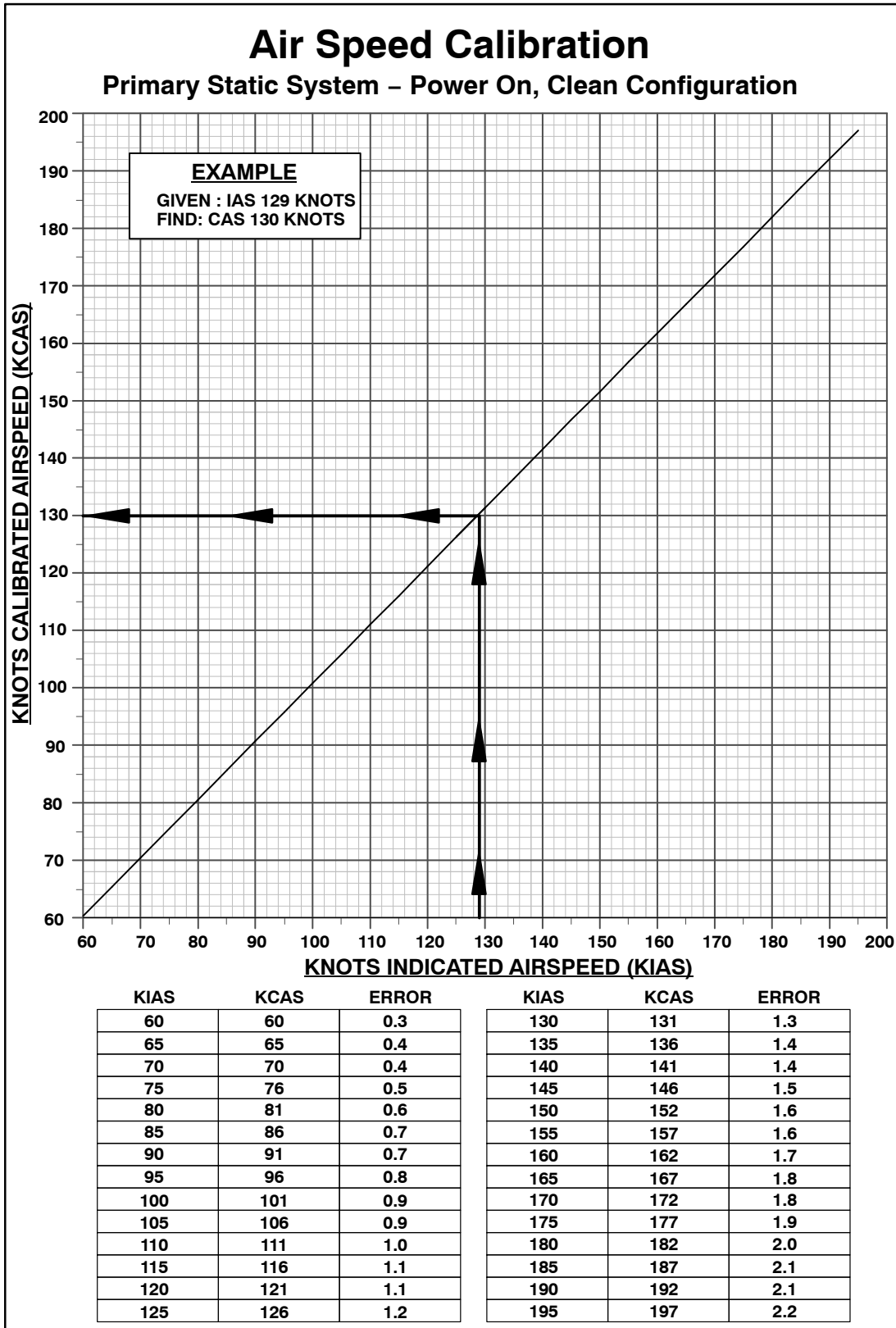

AIRSPEED CALIBRATION – PRIMARY STATIC SYSTEM
POWER OFF, CLEAN CONFIGURATION

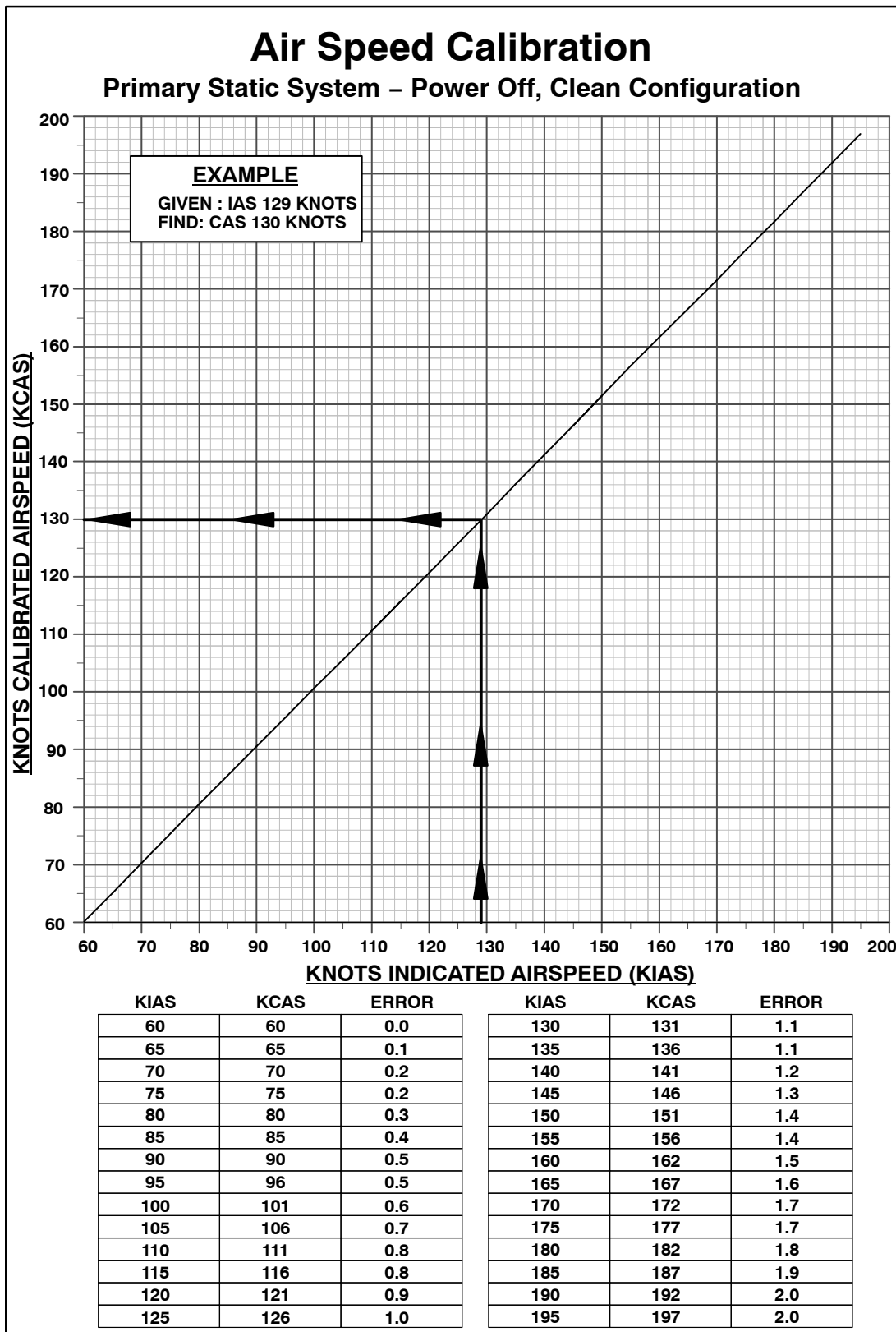

AIRSPEED CALIBRATION – PRIMARY STATIC SYSTEM
POWER ON, 10° FLAP, GEAR DOWN

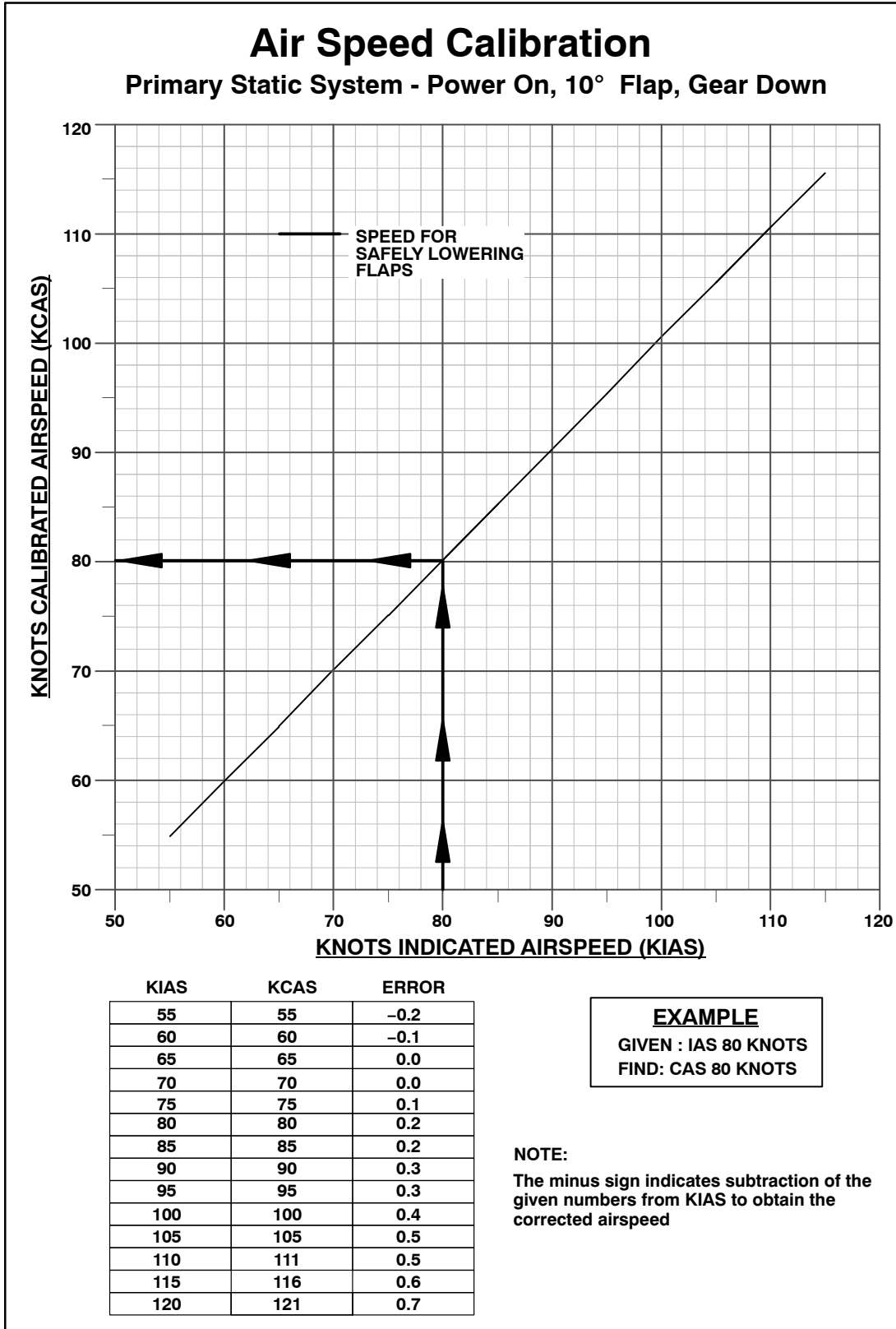

AIRSPEED CALIBRATION – PRIMARY STATIC SYSTEM
POWER OFF, 10° FLAP, GEAR DOWN

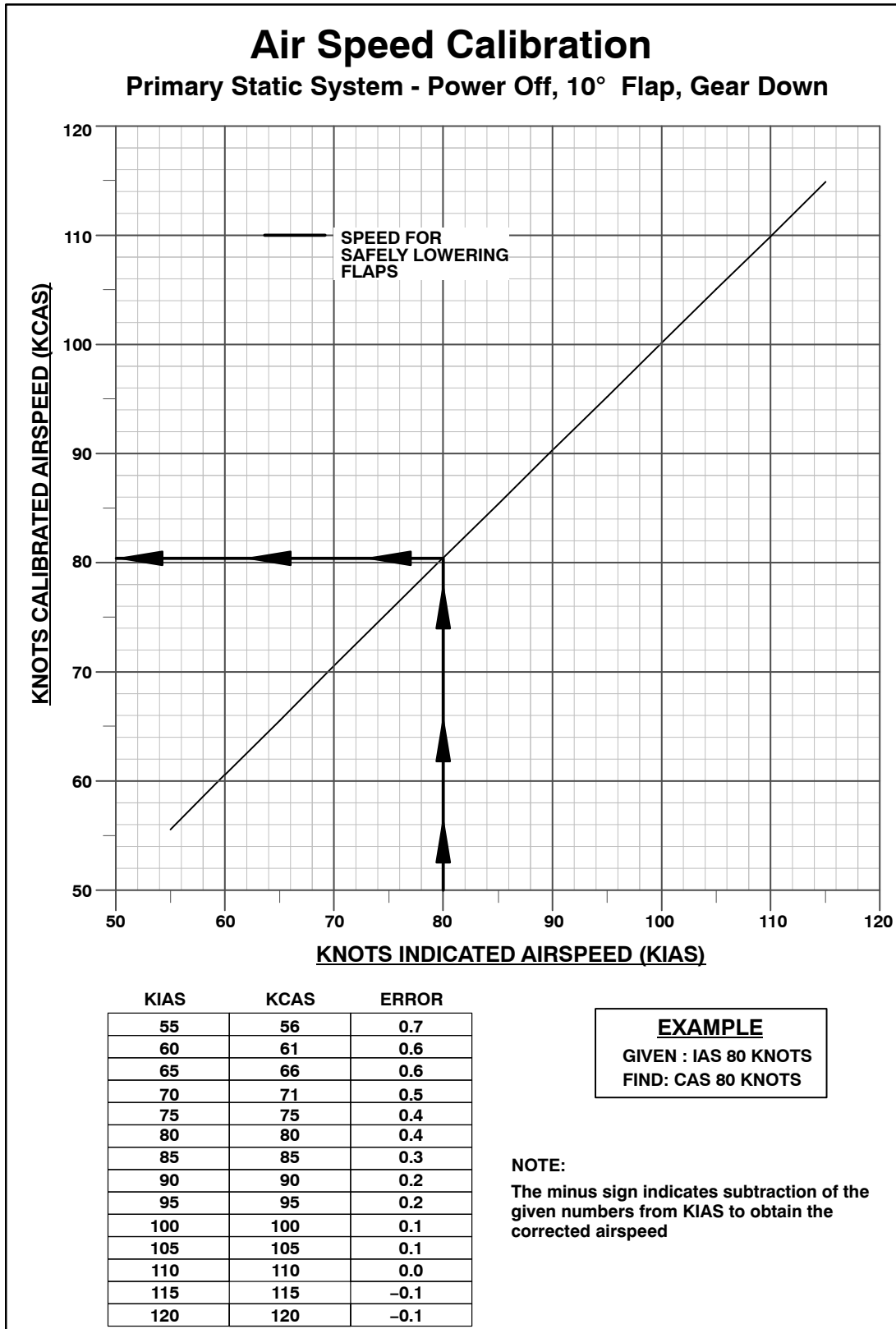

AIRSPEED CALIBRATION – PRIMARY STATIC SYSTEM
POWER ON, 33° FLAP, GEAR DOWN

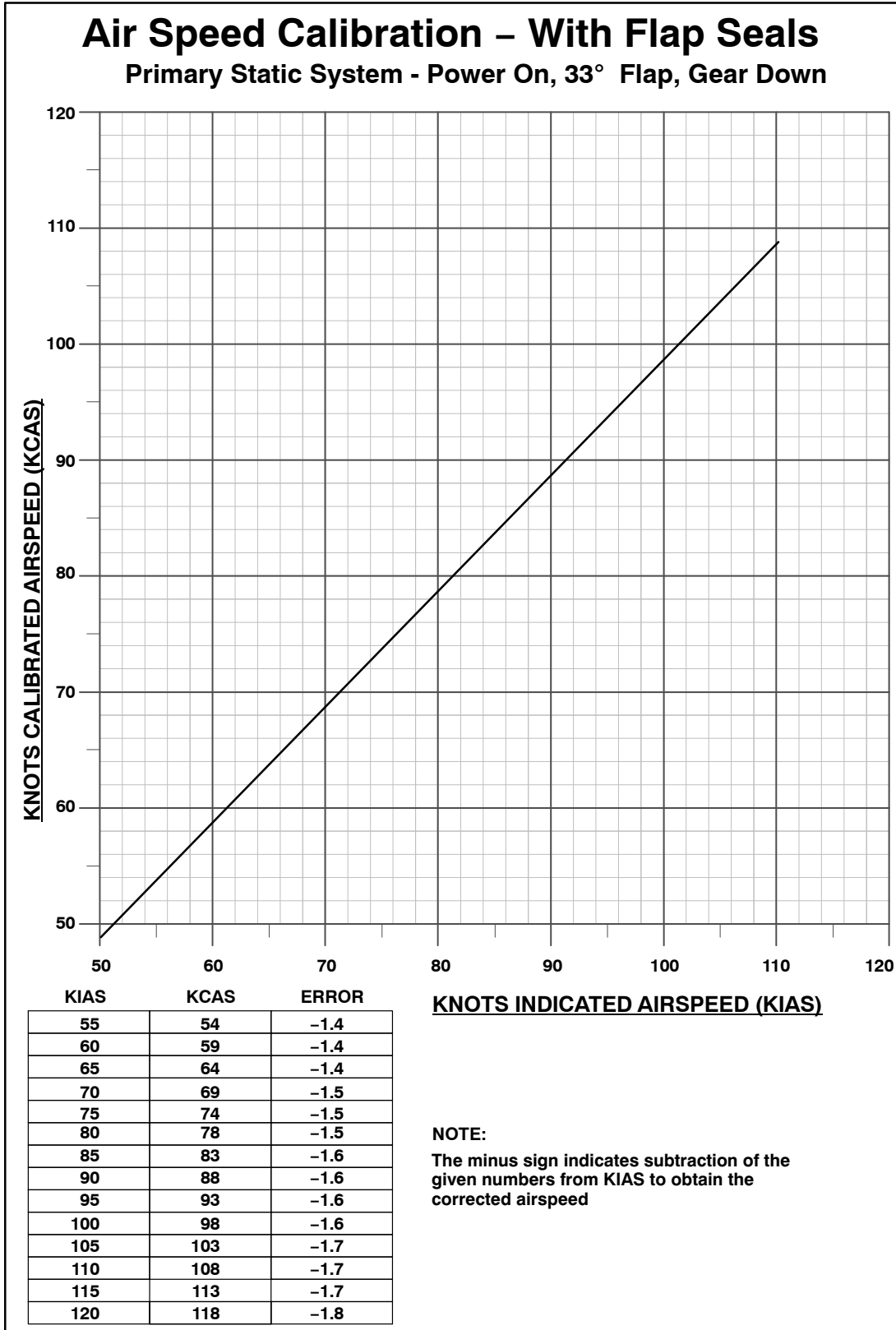

AIRSPPEED CALIBRATION WITH FLAP SEALS- PRIMARY STATIC SYSTEM
POWER OFF, 33° FLAP, GEAR DOWN

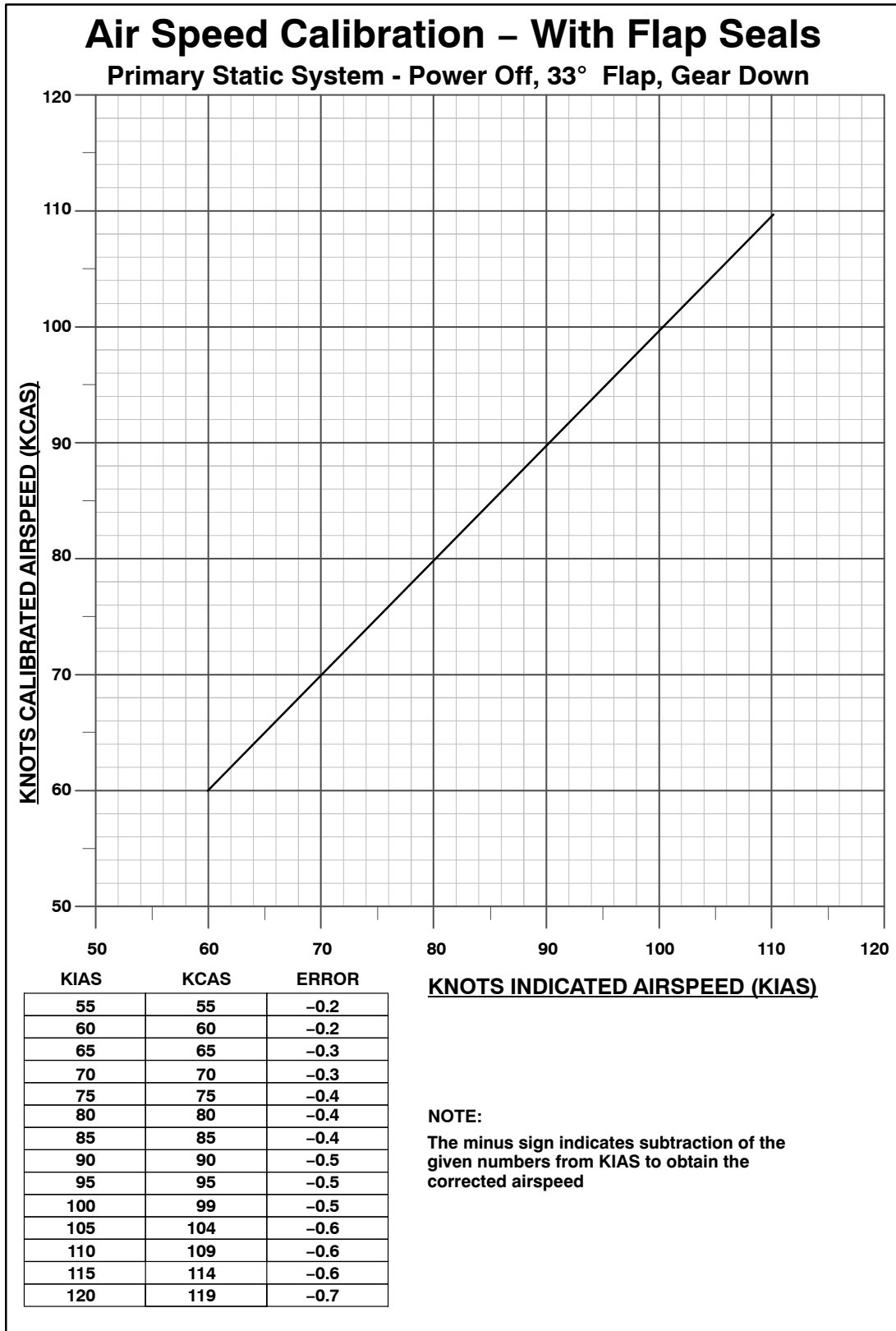

AIRSPEED CALIBRATION – ALTERNATE STATIC SYSTEM

KIAS	GEAR & FLAPS UP KIAS	GEAR & FLAPS DN (10°) KIAS	GEAR & FLAPS DN (33°) KIAS
50	3.0	0.0	-1.0
60	1.5	-1.2	-2.0
70	0.0	-2.2	-3.2
80	-1.8	-3.2	-4.5
90	-2.8	-4.0	-6.0
100	-3.0	-4.7	-7.4
110	-3.0	-5.4	-8.8
120	-3.0	-	-
130	-3.6	-	-
140	-4.5	-	-
150	-5.1	-	-
160	-5.6	-	-
170	-6.1	-	-
180	-6.5	-	-
190	-7.2	-	-
200	-7.9	-	-

NOTE:

The minus sign indicates subtraction of the given numbers from KIAS to obtain the corrected airspeed.

**CONDITIONS: Power-ON, Storm Window & Vents – CLOSED,
Heater & Defroster – ON or OFF**



ALTIMETER CORRECTION – PRIMARY STATIC SYSTEM

---	SEA LEVEL			12,500 FT.			25,000 FT.		
	KIAS	Gear & Flaps UP	Gear Dn/10° Flaps	Gear DN/33° Flaps	Gear & Flaps UP	Gear Dn/10° Flaps	Gear DN/33° Flaps	Gear & Flaps UP	Gear Dn/10° Flaps
50	1	-1	-6	1	-2	-9	2	-3	-15
60	2	0	-7	3	-1	-12	4	-1	-20
70	3	0	-9	4	0	-14	7	1	-24
80	4	1	-11	7	2	-17	11	3	-29
90	6	2	-13	9	4	-20	16	6	-34
100	8	4	-15	13	6	-23	21	10	-39
110	10	5	-17	16	8	-27	27	14	-45
120	12	-	-	20	-	-	34	-	-
130	15	-	-	24	-	-	41	-	-
140	18	-	-	29	-	-	49	-	-
150	22	-	-	35	-	-	58	-	-
160	25	-	-	40	-	-	68	-	-
170	29	-	-	47	-	-	78	-	-
180	33	-	-	53	-	-	90	-	-
190	38	-	-	60	-	-	102	-	-
200	42	-	-	68	-	-	115	-	-

NOTE:

The minus sign indicates subtraction of the given numbers from the indicated pressure altitude to obtain correct altitude, assuming zero instrument error.

EXAMPLE:

KIAS = 110 ALTIMETER CORRECTION: 8 ft.
 FLAPS = 10° INDICATED PRESSURE ALTITUDE: 12,500 ft.
 PRESSURE ALTITUDE; = 12,508 ft.



ALTIMETER CORRECTION – ALTERNATE STATIC SYSTEM

---	SEA LEVEL			12,500 FT.			25,000 FT.		
	KIAS	Gear & Flaps UP	Gear Dn/10° Flaps	Gear DN/33° Flaps	Gear & Flaps UP	Gear Dn/10° Flaps	Gear DN/33° Flaps	Gear & Flaps UP	Gear Dn/10° Flaps
50	13	0	-4	20	0	-7	30	0	-10
60	8	-6	-11	12	-9	-16	18	-14	-24
70	0	-14	-20	0	-20	-29	0	-31	-45
80	-13	-23	-32	-19	-34	-47	-29	-51	-72
90	-23	-32	-48	-33	-47	-71	-50	-72	-108
100	-27	-42	-66	-39	-62	-97	-68	-94	-148
110	-30	-53	-87	-43	-78	-127	-66	-119	-194
120	-32	-	-	-48	-	-	-72	-	-
130	-53	-	-	-77	-	-	-118	-	-
140	-57	-	-	-84	-	-	-127	-	-
150	-69	-	-	-102	-	-	-155	-	-
160	-82	-	-	-128	-	-	-182	-	-
170	-95	-	-	-139	-	-	-211	-	-
180	-107	-	-	-158	-	-	-248	-	-
190	-126	-	-	-185	-	-	-282	-	-
200	-146	-	-	-215	-	-	-327	-	-

NOTE:

The minus sign indicates subtraction of the given numbers from the indicated pressure altitude to obtain correct altitude, assuming zero instrument error. When the alternate static system source is first opened, there will be an immediate change to VS and ALT indications. The amount of indicated change will vary based on the current airspeed. The ALT indication will change to calibrated levels after the pressure stabilizes. (Refer to [Section V](#) for correction charts.) The autopilot will react to these changes if it is engaged in ALT HOLD mode.

CONDITIONS: Power – ON, Vents & Storm Window – CLOSED,
Heater & Defroster – ON or OFF.



STALL SPEED VS. ANGLE OF BANK

<p>ASSOCIATED CONDITIONS: FORWARD C.G. POWER IDLE</p>		EXAMPLE:		3000 LBS (1361 KGS)					
		WEIGHT		DOWN					
<p>NOTE: UP TO 500 FEET ALTITUDE LOSS MAY OCCUR DURING STALLS AT MAXIMUM WEIGHT</p>		LANDING GEAR		10°					
		FLAPS		45°					
		ANGLE OF BANK		74.5 KCAS (74.4 KIAS)					
		STALL SPEED							
GROSS WEIGHT	GEAR AND FLAP POSITION	ANGLE OF BANK							
		0°		30°		45°		60°	
		KCAS	KIAS	KCAS	KIAS	KCAS	KIAS	KCAS	KIAS
3368 LBS (1528 KGS)	GEAR UP, FLAPS 0°	66.9	66.8	71.9	71.7	79.6	79.3	94.6	94.1
	GEAR DOWN, FLAPS 10°	66.4	66.4	71.4	71.3	79.0	78.8	93.9	93.6
	GEAR DOWN FLAPS 33°	60.2	60.5	64.7	65.0	71.6	71.9	85.1	85.6
3000 LBS (1361 KGS)	GEAR UP, FLAPS 0°	63.1	63.1	67.8	67.7	75.1	74.9	89.3	88.8
	GEAR DOWN, FLAPS 10°	62.7	62.7	67.3	67.3	74.5	74.4	88.6	88.4
	GEAR DOWN FLAPS 33°	56.8	57.0	61.1	61.3	67.6	67.9	80.4	80.7
2700 LBS (1225 KGS)	GEAR UP, FLAPS 0°	59.9	59.9	64.4	64.3	71.2	71.1	84.7	84.3
	GEAR DOWN, FLAPS 10°	59.5	59.5	63.9	63.9	70.7	70.7	84.1	83.9
	GEAR DOWN FLAPS 33°	53.9	54.1	57.9	58.2	64.1	64.4	76.2	76.6



TAKEOFF DISTANCE - GROUND ROLL

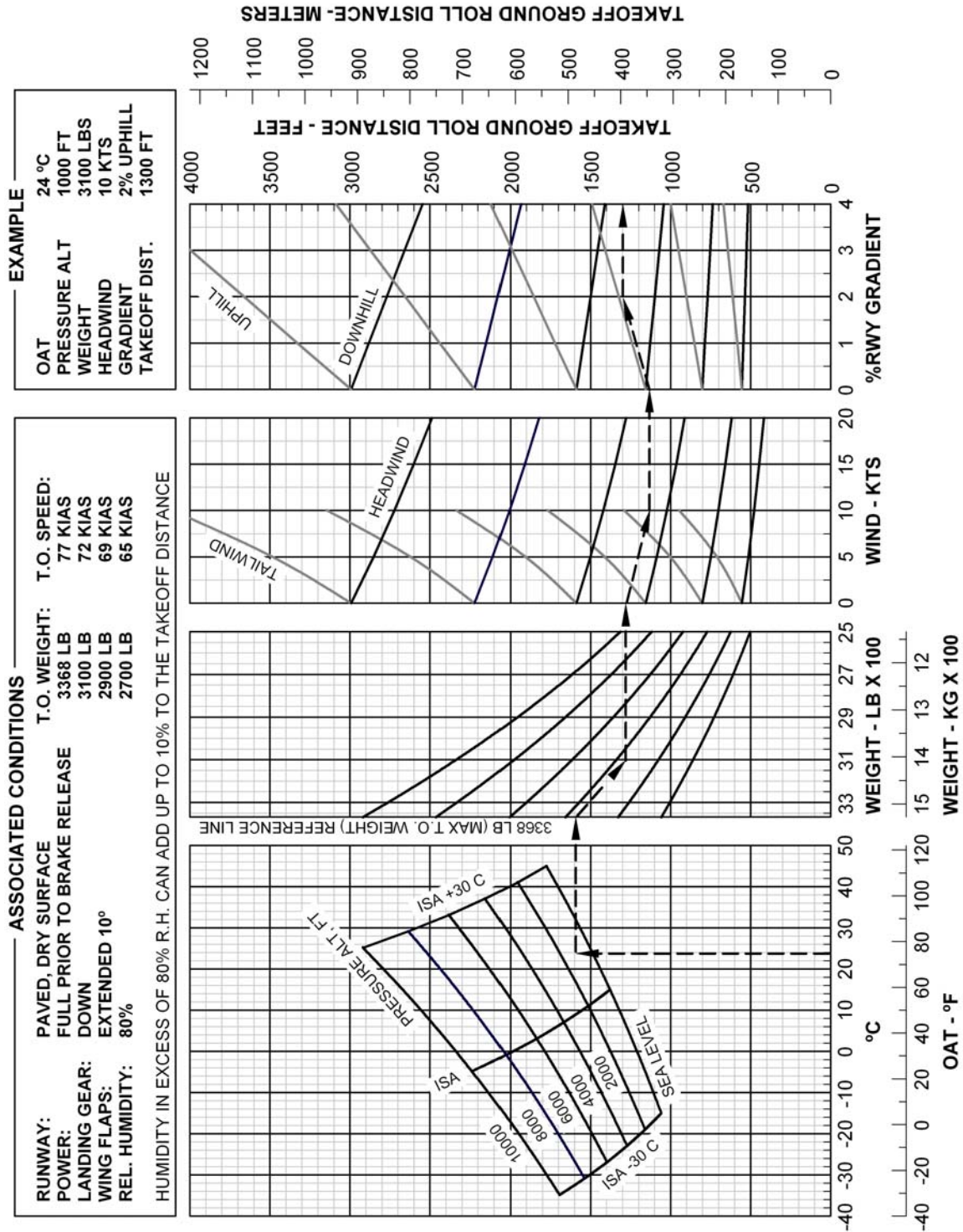

TAKEOFF DISTANCE - OVER 50' (15m) OBSTACLE

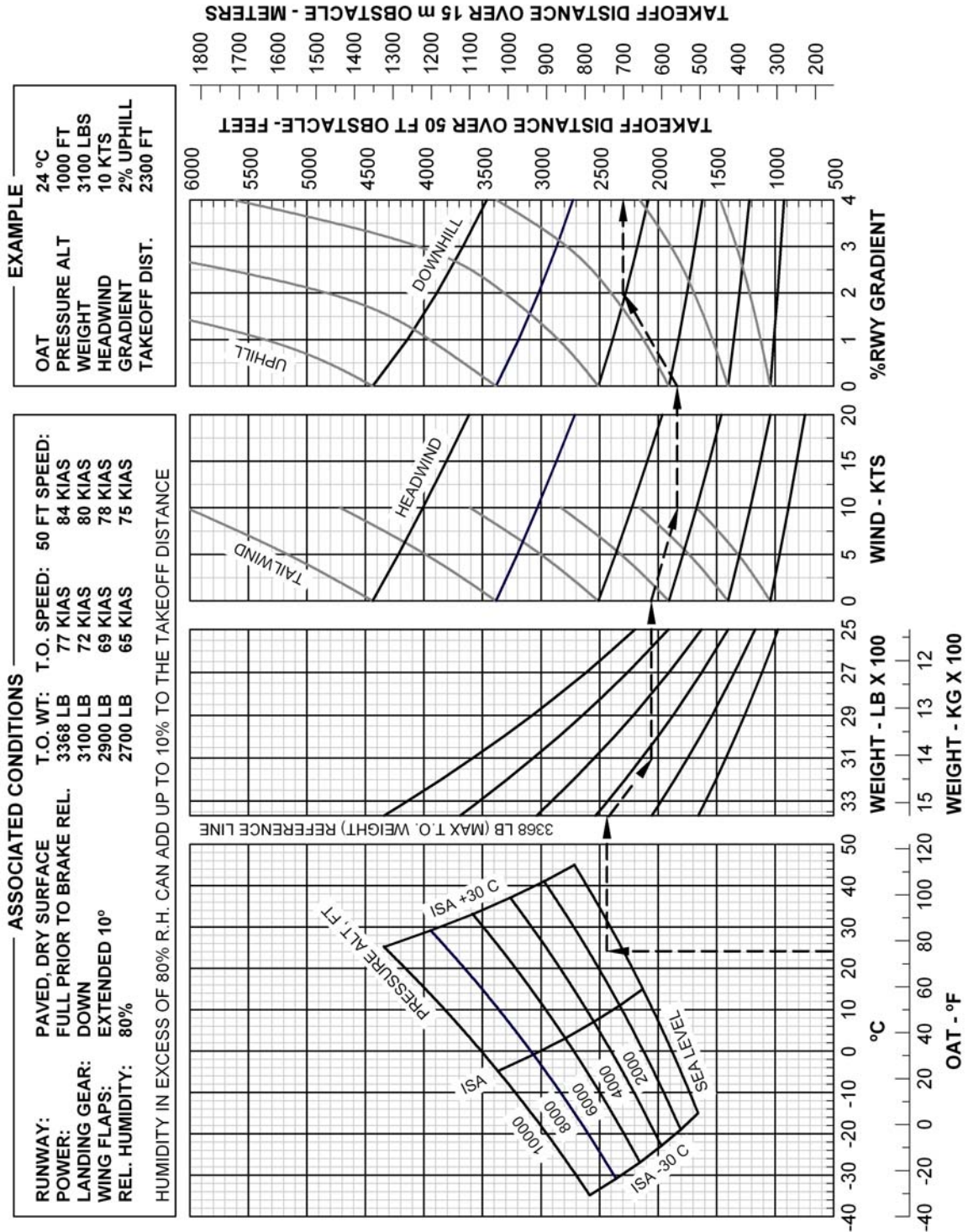

RATE OF CLIMB AT V_y

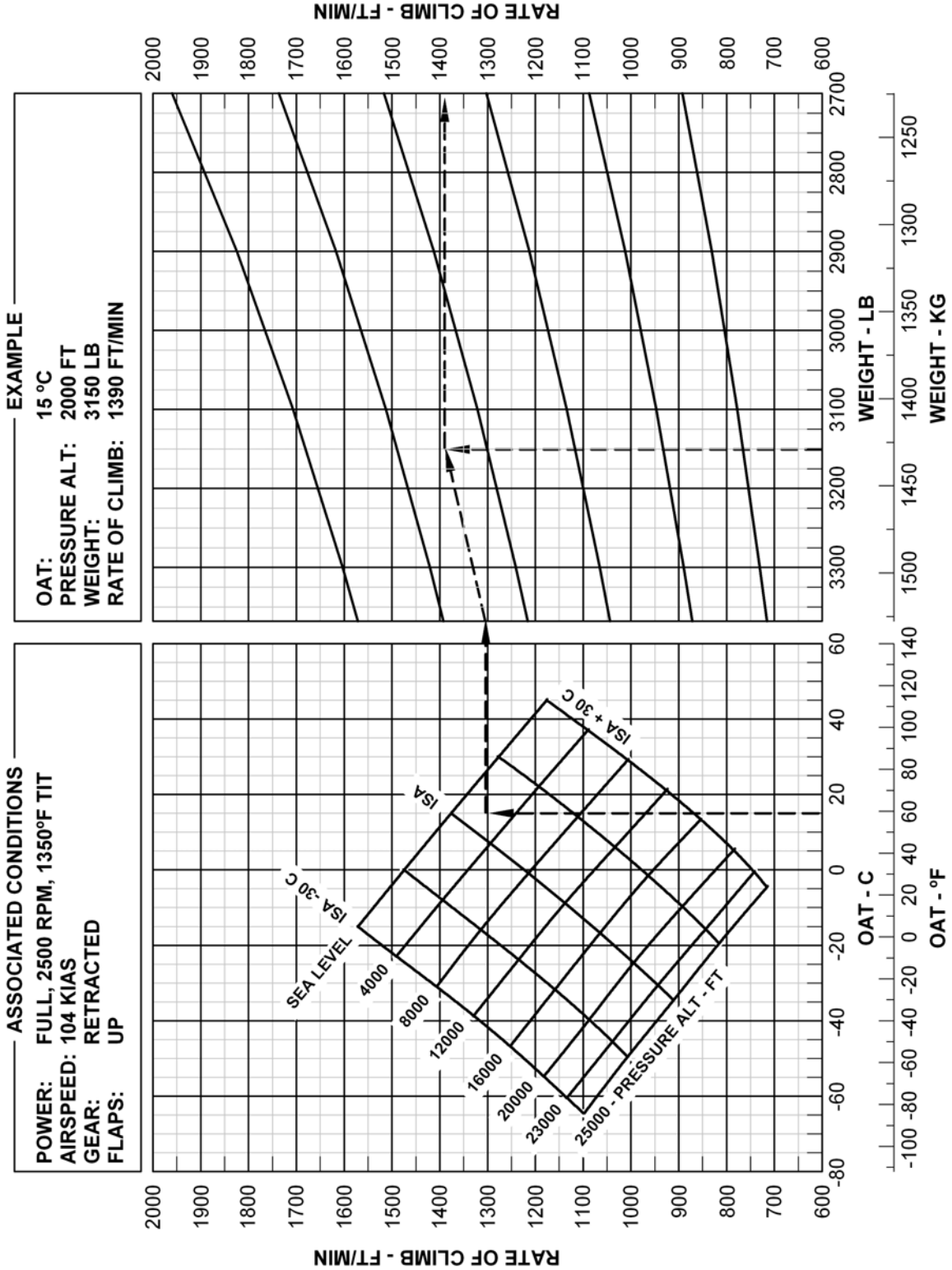

RATE OF CLIMB at 120 KIAS
(CRUISE CLIMB)

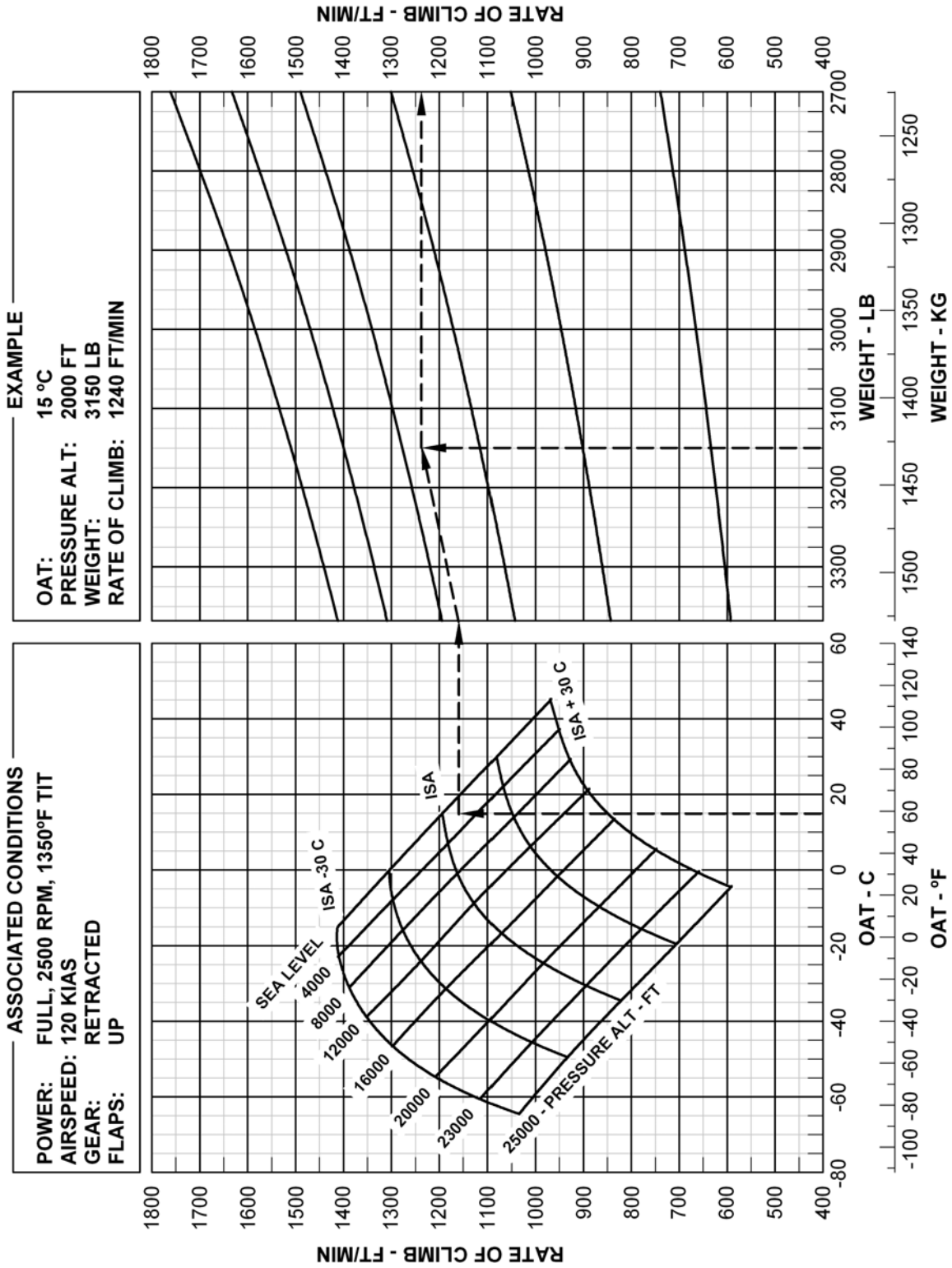

TIME - FUEL - DISTANCE
(to CLIMB at Vy)

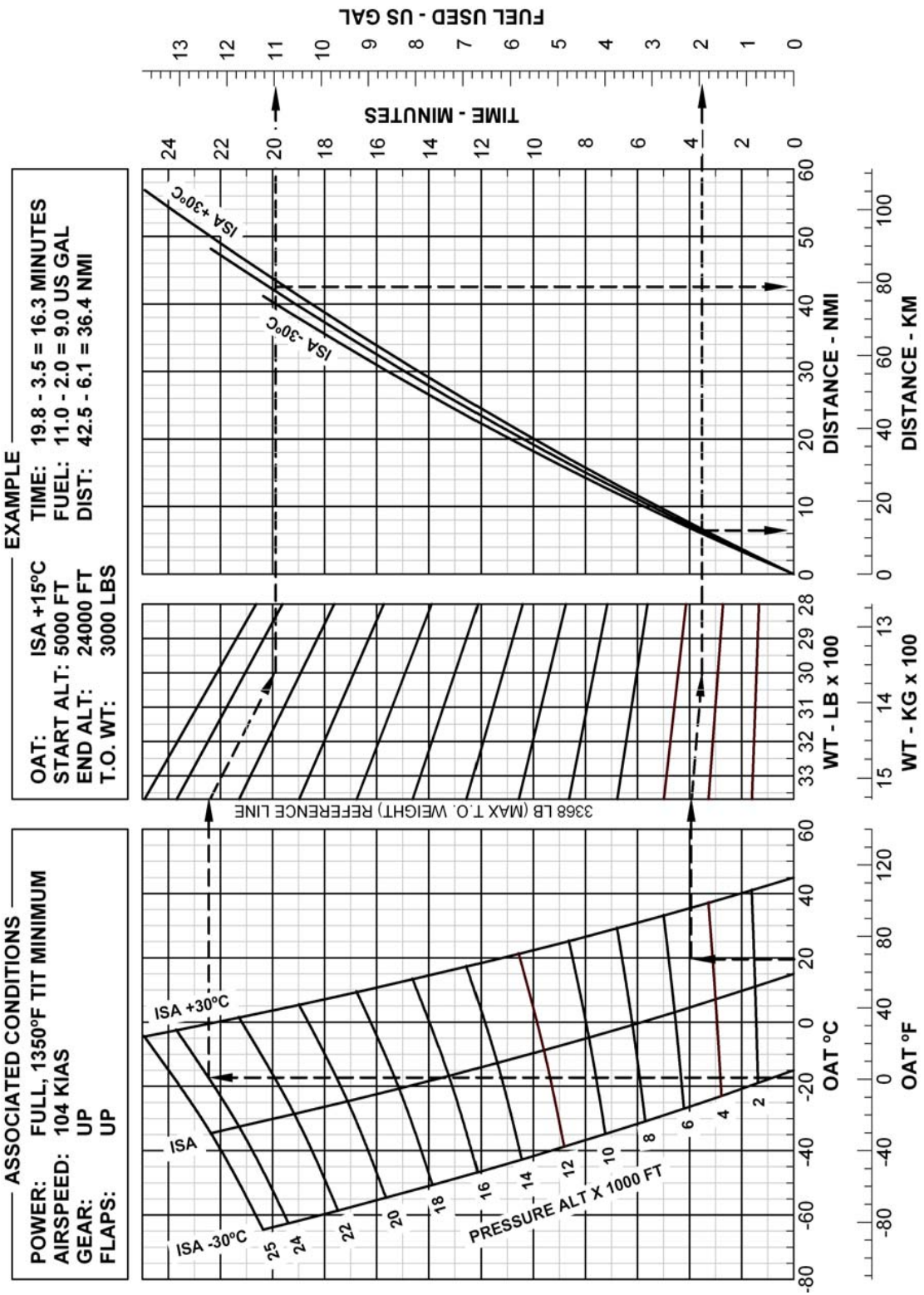

TIME - FUEL - DISTANCE
(to CLIMB at 120 KIAS)

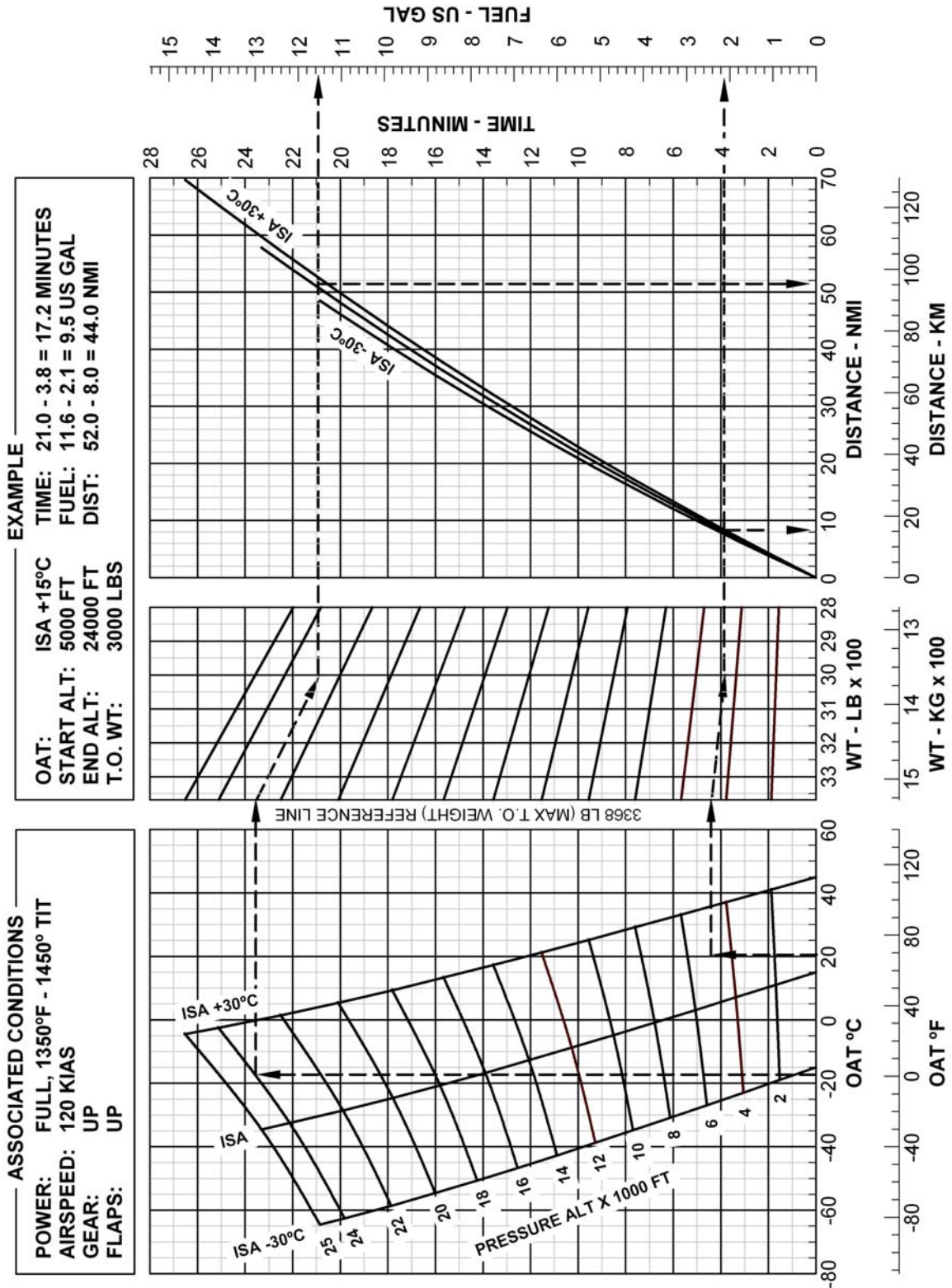

CRUISE POWER SETTINGS & FUEL FLOWS - BEST POWER

BEST POWER 50° Rich of Peak TIT															
Pr. Alt.	Manifold Pressure (inHg):	STD OAT	RPM:				STANDARD DAY CRUISE FUEL FLOW (gal/hr) @ 6.0 lb/gal								
			2500		2400		2300		2200		2100				
			30.5	29.0	26.0	22.0	30.5	27.0	24.0	21.0	28.0	25.0	22.0	19.0	22.0
0	15° C 59° F		21.4	20.6	18.7	16.1	20.4	18.0	15.8	13.4	17.8	15.5	13.1	10.5	11.0
2000	11° C 52° F		21.4	20.5	18.7	16.0	20.4	18.1	16.0	13.7	17.9	15.9	13.9	11.7	12.5
4000	7° C 45° F		21.3	20.4	18.6	15.9	20.3	18.1	16.1	14.0	17.9	16.0	14.0	11.9	12.5
6000	3° C 38° F		21.3	20.4	18.5	15.8	20.3	18.2	16.2	14.2	17.8	16.0	14.0	12.0	12.5
8000	-1° C 30° F		21.2	20.3	18.4	15.8	20.2	18.2	16.3	14.4	17.8	16.0	14.1	12.1	12.5
10000	-5° C 23° F		21.1	20.2	18.3	15.7	20.2	18.2	16.4	14.5	17.8	16.0	14.1	12.1	12.4
12000	-9° C 16° F		21.1	20.1	18.2	15.7	20.2	18.2	16.4	14.5	17.8	16.0	14.1	12.2	12.4
14000	-13° C 9° F		21.0	20.1	18.2	15.6	20.2	18.1	16.3	14.5	17.8	15.9	14.1	12.2	12.4
16000	-17° C 2° F		21.0	20.0	18.1	15.6	20.2	18.1	16.3	14.5	17.8	15.9	14.1	12.2	12.4
18000	-21° C -5° F		21.0	20.0	18.1	15.6	20.2	18.0	16.2	14.5	17.8	15.9	14.1	12.3	12.5
20000	-25° C -12° F		20.9	19.9	18.0	15.6	20.2	18.0	16.2	14.4	17.7	15.9	14.1	12.3	12.6
22000	-29° C -19° F		20.9	19.9	18.0	15.6	20.2	17.9	16.2	14.5	17.7	15.9	14.1	12.4	12.7
24000	-33° C -27° F		20.9	19.9	18.0	15.7	20.1	17.9	16.2	14.5	17.7	15.9	14.2	12.6	12.8
25000	-35° C -30° F		20.9	19.9	18.0	15.7	20.1	17.9	16.2	14.6	17.6	15.9	14.2	12.7	12.8

Note 1: At altitudes above 22,000 feet, power settings above 2300 rpm must be operated at 1675°F TIT or richer.

Note 2: When operating above 30.5 inHg manifold pressure only FULL RICH mixture is permitted.

Note 3: Decrease Fuel Flow 0.5 gal/hr for each 10°C above standard temperature.

Note 4: Increase Fuel Flow 0.5 gal/hr for each 10°C below standard temperature.

Example: for 2500 RPM, 25000 ft Pr. Alt., -25°C OAT, 30.5 inHg MAP the fuel flow is: 21.3 - 0.5 = 20.8 gal/hr

Some (low) power settings may not be attainable due to low cylinder or oil temperatures depending on ambient conditions



CRUISE POWER SETTINGS & FUEL FLOWS - BEST ECONOMY

BEST ECONOMY 50° Lean of Peak TIT														
Pr. Alt.	STD OAT	2500				2400				2300				2200
		30.5	29.0	26.0	22.0	30.5	27.0	24.0	21.0	28.0	25.0	22.0	19.0	21.0
STANDARD DAY CRUISE FUEL FLOW (gal/hr) @ 6.0 lb/gal														
Manifold Pressure (inHg):	RPM:	18.5	17.8	16.2	13.8	17.7	15.6	13.7	11.5	15.5	13.5	11.3	9.7	10.8
0	15° C 59° F	18.5	17.8	16.2	13.8	17.7	15.6	13.7	11.5	15.5	13.5	11.3	9.7	10.8
2000	11° C 52° F	18.4	17.7	16.1	13.8	17.6	15.7	13.8	11.8	15.6	13.9	12.0	10.0	10.9
4000	7° C 45° F	18.4	17.6	16.1	13.7	17.6	15.7	14.0	12.1	15.5	13.9	12.1	10.2	10.9
6000	3° C 38° F	18.3	17.5	16.0	13.6	17.5	15.7	14.1	12.3	15.5	13.9	12.2	10.3	10.9
8000	-1° C 30° F	18.2	17.5	15.9	13.6	17.5	15.7	14.1	12.4	15.5	13.9	12.2	10.4	10.8
10000	-5° C 23° F	18.1	17.4	15.8	13.5	17.4	15.7	14.2	12.5	15.5	13.9	12.2	10.4	10.8
12000	-9° C 16° F	18.1	17.3	15.7	13.5	17.4	15.7	14.2	12.5	15.5	13.9	12.2	10.5	10.8
14000	-13° C 9° F	18.1	17.3	15.7	13.5	17.4	15.7	14.1	12.5	15.5	13.9	12.2	10.5	10.8
16000	-17° C 2° F	18.1	17.3	15.6	13.5	17.4	15.6	14.1	12.5	15.5	13.9	12.2	10.5	10.8
18000	-21° C -5° F	18.0	17.2	15.6	13.5	17.4	15.6	14.1	12.5	15.5	13.9	12.2	10.6	10.9
20000	-25° C -12° F	18.1	17.2	15.6	13.5	17.5	15.6	14.0	12.5	15.5	13.8	12.3	10.6	11.0
22000	-29° C -19° F	18.1	17.2	15.6	13.5	17.5	15.6	14.0	12.5	15.4	13.8	12.3	10.7	11.1
24000	-33° C -27° F	18.1	17.2	15.6	13.5	17.5	15.6	14.0	12.6	15.4	13.8	12.3	10.9	11.1
25000	-35° C -30° F	18.1	17.2	15.6	13.5	17.5	15.6	14.1	12.7	15.4	13.8	12.4	11.0	11.2

Note 1: At altitudes above 22,000 feet, power settings above 2300 rpm must be operated at 1675° F TIT or richer.

Note 2: When operating above 30.5 inHg manifold pressure only FULL RICH mixture is permitted.

Note 3: Decrease Fuel Flow 0.5 gal/hr for each 10°C above standard temperature.

Note 4: Increase Fuel Flow 0.5 gal/hr for each 10°C below standard temperature.

Example: for 2500 RPM, 20000 ft Pr. Alt., -15°C OAT, 30.5 inHg MAP the fuel flow is: 18.4 - 0.5 = 17.9 gal/hr

Filled Speed & Fuel Flow table entries indicate conditions that may not be attainable without exceeding engine limitation Note 1 on Power Chart



SPEED and POWER SETTINGS vs ALTITUDE – (BEST POWER)

Conditions:

Example:

Mixture: Best Power (50° F Rich of Peak TIT)	Pressure Altitude: 16000 ft
Cruise Weight: 3100 LB	Propeller Speed: 2400 RPM
Altimeter: Set to 29.92	Manifold Pressure: 30.5 in HG
Configuration: Clean	Outside Air Temp: -16°C
	True Airspeed: 220 KTAS
	Fuel Flow: 20.3 GPH

25000 Ft. Pressure Altitude							
ΔISA: (OAT)		-30 -54	(-65)°C (-81)°F	0 0	(-34)°C (-30)°F	30 54	(-4)°C (24)°F
RPM	MAP	KTAS	GPH	KTAS	GPH	KTAS	GPH
2500	30.5	241	22.6	242	21.1	240	19.5
2500	29.0	237	21.5	238	20.1	236	18.5
2500	26.0	228	19.4	229	18.1	227	16.8
2500	22.0	215	16.9	216	15.8	213	14.6
2400	30.5	237	21.8	239	20.3	237	18.8
2400	27.0	228	19.4	229	18.1	227	16.7
2400	24.0	219	17.5	220	16.4	218	15.2
2400	21.0	210	15.8	209	14.8	207	13.7
2300	28.0	226	19.1	227	17.8	225	16.5
2300	25.0	218	17.2	218	16.0	215	14.8
2300	22.0	208	15.4	208	14.4	205	13.3
2300	19.0	197	13.7	196	12.8	192	11.9
2200	21.0	199	13.9	198	13.0	195	12.0

24000 Ft. Pressure Altitude							
ΔISA: (OAT)		-30 -54	(-63)°C (-81)°F	0 0	(-32)°C (-27)°F	30 54	(-2)°C (27)°F
RPM	MAP	KTAS	GPH	KTAS	GPH	KTAS	GPH
2500	30.5	239	22.6	240	21.1	238	19.5
2500	29.0	235	21.5	236	20.1	234	18.6
2500	26.0	226	19.4	227	18.2	225	16.8
2500	22.0	213	16.9	214	15.8	212	14.6
2400	30.5	235	21.8	237	20.3	235	18.8
2400	27.0	226	19.4	227	18.1	225	16.7
2400	24.0	217	17.5	218	16.4	215	15.1
2400	21.0	207	15.7	207	14.7	205	13.6
2300	28.0	225	19.1	226	17.8	224	16.5
2300	25.0	216	17.2	216	16.1	214	14.8
2300	22.0	206	15.4	206	14.4	203	13.3
2300	19.0	195	13.6	194	12.7	191	11.8
2200	21.0	197	13.8	197	12.9	193	12.0

Some (low) power settings may not be attainable due to low cylinder or oil temperatures depending on ambient conditions



SPEED and POWER SETTINGS vs ALTITUDE – (BEST POWER)

22000 Ft. Pressure Altitude							
ΔISA: (OAT)		-30 -54	(-59) ^{°C} (-73) ^{°F}	0 0	(-28) ^{°C} (-19) ^{°F}	30 54	(2) ^{°C} (35) ^{°F}
RPM	MAP	KTAS	GPH	KTAS	GPH	KTAS	GPH
2500	30.5	235	22.6	236	21.1	235	19.5
2500	29.0	231	21.5	232	20.1	231	18.6
2500	26.0	222	19.5	223	18.2	221	16.8
2500	22.0	209	16.9	210	15.8	208	14.6
2400	30.5	232	21.8	233	20.4	231	18.8
2400	27.0	222	19.4	223	18.1	221	16.8
2400	24.0	213	17.5	214	16.3	211	15.1
2400	21.0	203	15.6	203	14.6	201	13.5
2300	28.0	221	19.2	222	17.9	220	16.6
2300	25.0	212	17.2	213	16.1	211	14.9
2300	22.0	202	15.3	202	14.3	199	13.2
2300	19.0	191	13.5	190	12.6	187	11.7
2200	21.0	193	13.8	193	12.9	190	11.9

20000 Ft. Pressure Altitude							
ΔISA: (OAT)		-30 -54	(-55) ^{°C} (-66) ^{°F}	0 0	(-24) ^{°C} (-12) ^{°F}	30 54	(6) ^{°C} (42) ^{°F}
RPM	MAP	KTAS	GPH	KTAS	GPH	KTAS	GPH
2500	30.5	230	22.6	232	21.1	231	19.6
2500	29.0	226	21.6	228	20.1	226	18.6
2500	26.0	218	19.5	219	18.2	217	16.9
2500	22.0	205	16.9	206	15.8	204	14.6
2400	30.5	227	21.8	228	20.4	227	18.8
2400	27.0	218	19.4	219	18.2	217	16.8
2400	24.0	209	17.5	210	16.4	208	15.1
2400	21.0	199	15.6	200	14.6	197	13.5
2300	28.0	217	19.2	218	17.9	216	16.6
2300	25.0	208	17.2	209	16.1	207	14.9
2300	22.0	198	15.3	198	14.3	196	13.2
2300	19.0	187	13.4	186	12.5	183	11.6
2200	21.0	189	13.7	189	12.8	186	11.8

Some (low) power settings may not be attainable due to low cylinder or oil temperatures depending on ambient conditions



SPEED and POWER SETTINGS vs ALTITUDE – (BEST POWER)

18000 Ft. Pressure Altitude							
ΔISA: (OAT)		-30 -54	(-51)°C (-59)°F	0 0	(-20)°C (-5)°F	30 54	(10)°C (49)°F
RPM	MAP	KTAS	GPH	KTAS	GPH	KTAS	GPH
2500	30.5	226	22.6	228	21.2	226	19.6
2500	29.0	222	21.6	224	20.2	222	18.7
2500	26.0	214	19.5	215	18.3	213	16.9
2500	22.0	202	16.9	202	15.8	200	14.6
2400	30.5	223	21.8	225	20.4	223	18.8
2400	27.0	214	19.5	215	18.2	213	16.8
2400	24.0	206	17.6	206	16.4	204	15.2
2400	21.0	196	15.7	196	14.6	193	13.5
2300	28.0	214	19.2	214	17.9	212	16.6
2300	25.0	204	17.2	205	16.1	203	14.9
2300	22.0	195	15.3	194	14.3	192	13.2
2300	19.0	183	13.3	183	12.5	180	11.5
2200	21.0	186	13.6	185	12.7	182	11.7

16000 Ft. Pressure Altitude							
ΔISA: (OAT)		-30 -54	(-47)°C (-52)°F	0 0	(-16)°C (2)°F	30 54	(14)°C (56)°F
RPM	MAP	KTAS	GPH	KTAS	GPH	KTAS	GPH
2500	30.5	223	22.6	223	21.2	222	19.6
2500	29.0	219	21.6	219	20.2	218	18.7
2500	26.0	210	19.6	211	18.3	209	16.9
2500	22.0	198	16.9	198	15.8	196	14.6
2400	30.5	219	21.8	220	20.3	218	18.8
2400	27.0	210	19.5	211	18.2	209	16.9
2400	24.0	201	17.6	202	16.5	200	15.2
2400	21.0	192	15.7	192	14.7	190	13.6
2300	28.0	209	19.2	210	18.0	208	16.6
2300	25.0	200	17.2	200	16.1	198	14.9
2300	22.0	190	15.3	190	14.3	188	13.2
2300	19.0	179	13.3	179	12.4	176	11.5
2200	21.0	181	13.5	181	12.6	178	11.7

Some (low) power settings may not be attainable due to low cylinder or oil temperatures depending on ambient conditions



SPEED and POWER SETTINGS vs ALTITUDE – (BEST POWER)

14000 Ft. Pressure Altitude							
Δ ISA: (OAT)		-30 -54	(-43) ^{°C} (-45) ^{°F}	0 0	(-12) ^{°C} (9) ^{°F}	30 54	(18) ^{°C} (63) ^{°F}
RPM	MAP	KTAS	GPH	KTAS	GPH	KTAS	GPH
2500	30.5	218	22.7	219	21.2	217	19.6
2500	29.0	214	21.7	215	20.3	213	18.8
2500	26.0	206	19.6	206	18.4	204	17.0
2500	22.0	193	16.9	193	15.8	191	14.6
2400	30.5	215	21.8	216	20.4	214	18.8
2400	27.0	206	19.6	206	18.3	205	16.9
2400	24.0	198	17.7	197	16.5	196	15.3
2400	21.0	188	15.7	188	14.7	186	13.6
2300	28.0	205	19.2	205	18.0	203	16.6
2300	25.0	196	17.2	196	16.1	194	14.9
2300	22.0	186	15.3	186	14.3	184	13.2
2300	19.0	175	13.2	175	12.4	172	11.5
2200	21.0	177	13.5	177	12.6	174	11.7

12000 Ft. Pressure Altitude							
Δ ISA: (OAT)		-30 -54	(-39) ^{°C} (-38) ^{°F}	0 0	(-8) ^{°C} (16) ^{°F}	30 54	(22) ^{°C} (70) ^{°F}
RPM	MAP	KTAS	GPH	KTAS	GPH	KTAS	GPH
2500	30.5	214	22.7	214	21.2	213	19.7
2500	29.0	210	21.7	210	20.3	209	18.8
2500	26.0	202	19.7	202	18.4	200	17.1
2500	22.0	189	17.0	189	15.9	187	14.7
2400	30.5	211	21.8	211	20.4	209	18.9
2400	27.0	202	19.6	202	18.3	200	17.0
2400	24.0	193	17.7	193	16.5	192	15.3
2400	21.0	184	15.7	183	14.7	181	13.6
2300	28.0	201	19.2	201	18.0	199	16.6
2300	25.0	192	17.3	192	16.1	190	14.9
2300	22.0	182	15.3	182	14.3	180	13.2
2300	19.0	171	13.2	171	12.4	168	11.4
2200	21.0	174	13.5	173	12.6	170	11.7

Some (low) power settings may not be attainable due to low cylinder or oil temperatures depending on ambient conditions



SPEED and POWER SETTINGS vs ALTITUDE – (BEST POWER)

10000 Ft. Pressure Altitude							
ΔISA: (OAT)		-30 -54	(-35)°C (-31)°F	0 0	(-4)°C (23)°F	30 54	(26)°C (77)°F
RPM	MAP	KTAS	GPH	KTAS	GPH	KTAS	GPH
2500	30.5	209	22.8	210	21.3	208	19.7
2500	29.0	206	21.8	206	20.4	204	18.9
2500	26.0	197	19.8	198	18.5	196	17.1
2500	22.0	185	17.0	185	15.9	183	14.7
2400	30.5	206	21.8	207	20.4	205	18.9
2400	27.0	197	19.6	197	18.4	196	17.0
2400	24.0	189	17.7	189	16.5	187	15.3
2400	21.0	179	15.7	179	14.7	177	13.6
2300	28.0	196	19.2	196	18.0	195	16.6
2300	25.0	188	17.3	188	16.2	186	15.0
2300	22.0	178	15.3	178	14.3	175	13.2
2300	19.0	167	13.2	166	12.3	164	11.4
2200	21.0	169	13.5	169	12.6	166	11.7

8000 Ft. Pressure Altitude							
ΔISA: (OAT)		-30 -54	(-31)°C (-24)°F	0 0	(0)°C (30)°F	30 54	(30)°C (84)°F
RPM	MAP	KTAS	GPH	KTAS	GPH	KTAS	GPH
2500	30.5	205	22.8	205	21.4	204	19.8
2500	29.0	201	21.9	202	20.5	200	19.0
2500	26.0	193	19.9	193	18.6	191	17.2
2500	22.0	180	17.1	180	16.0	178	14.8
2400	30.5	202	21.8	202	20.4	200	18.9
2400	27.0	193	19.6	193	18.4	191	17.0
2400	24.0	184	17.6	184	16.5	182	15.3
2400	21.0	175	15.6	174	14.6	171	13.5
2300	28.0	192	19.2	192	18.0	190	16.7
2300	25.0	183	17.3	183	16.2	181	15.0
2300	22.0	174	15.2	173	14.3	171	13.2
2300	19.0	162	13.1	161	12.3	159	11.4
2200	21.0	166	13.5	165	12.7	163	11.7

Some (low) power settings may not be attainable due to low cylinder or oil temperatures depending on ambient conditions



SPEED and POWER SETTINGS vs ALTITUDE – (BEST POWER)

6000 Ft. Pressure Altitude							
Δ ISA: (OAT)		-30 -54	(-27) ^{°C} (-16) ^{°F}	0 0	(3) ^{°C} (33) ^{°F}	30 54	(33) ^{°C} (92) ^{°F}
RPM	MAP	KTAS	GPH	KTAS	GPH	KTAS	GPH
2500	30.5	201	22.9	201	21.4	199	19.9
2500	29.0	197	22.0	197	20.6	195	19.0
2500	26.0	189	20.0	189	18.7	187	17.3
2500	22.0	175	17.1	175	16.0	173	14.8
2400	30.5	197	21.9	197	20.5	196	19.0
2400	27.0	188	19.6	188	18.4	186	17.0
2400	24.0	179	17.6	179	16.4	177	15.2
2400	21.0	169	15.4	168	14.4	166	13.4
2300	28.0	187	19.2	187	18.0	186	16.7
2300	25.0	179	17.3	178	16.2	177	15.0
2300	22.0	169	15.2	168	14.2	166	13.2
2300	19.0	157	13.0	156	12.2	154	11.3
2200	21.0	161	13.6	161	12.7	158	11.8

4000 Ft. Pressure Altitude							
Δ ISA: (OAT)		-30 -54	(-23) ^{°C} (-9) ^{°F}	0 0	(7) ^{°C} (45) ^{°F}	30 54	(37) ^{°C} (99) ^{°F}
RPM	MAP	KTAS	GPH	KTAS	GPH	KTAS	GPH
2500	30.5	196	23.0	196	21.5	194	19.9
2500	29.0	192	22.0	192	20.6	190	19.1
2500	26.0	184	20.1	184	18.8	182	17.4
2500	22.0	170	17.2	170	16.1	168	14.9
2400	30.5	193	21.9	193	20.5	191	19.0
2400	27.0	184	19.6	183	18.3	181	17.0
2400	24.0	174	17.5	173	16.3	171	15.1
2400	21.0	163	15.2	162	14.2	160	13.2
2300	28.0	183	19.3	183	18.0	181	16.7
2300	25.0	174	17.3	174	16.2	172	15.0
2300	22.0	164	15.1	163	14.2	161	13.1
2300	19.0	151	12.9	151	12.1	148	11.2
2200	21.0	157	13.6	156	12.7	154	11.8

Some (low) power settings may not be attainable due to low cylinder or oil temperatures depending on ambient conditions



SPEED and POWER SETTINGS vs ALTITUDE – (BEST POWER)

2000 Ft. Pressure Altitude							
ΔISA: (OAT)		-30 -54	(-19)°C (-2)°F	0 0	(11)°C (52)°F	30 54	(41)°C (106)°F
RPM	MAP	KTAS	GPH	KTAS	GPH	KTAS	GPH
2500	30.5	191	23.0	191	21.6	190	20.0
2500	29.0	187	22.1	187	20.7	186	19.2
2500	26.0	179	20.1	179	18.9	177	17.5
2500	22.0	165	17.3	165	16.2	163	15.0
2400	30.5	188	22.0	188	20.6	186	19.0
2400	27.0	179	19.5	178	18.3	176	17.0
2400	24.0	169	17.3	167	16.2	165	15.0
2400	21.0	157	14.9	156	14.0	153	13.0
2300	28.0	178	19.3	178	18.1	176	16.7
2300	25.0	169	17.2	169	16.1	167	14.9
2300	22.0	158	15.0	157	14.1	155	13.0
2300	19.0	145	12.7	145	11.9	142	11.0
2200	21.0	152	13.6	151	12.7	149	11.8

0 Ft. Pressure Altitude							
ΔISA: (OAT)		-30 -54	(-15)°C (5)°F	0 0	(15)°C (59)°F	30 54	(45)°C (113)°F
RPM	MAP	KTAS	GPH	KTAS	GPH	KTAS	GPH
2500	30.5	186	23.1	186	21.6	184	20.0
2500	29.0	182	22.2	182	20.7	180	19.2
2500	26.0	173	20.2	173	18.9	171	17.5
2500	22.0	160	17.4	160	16.3	158	15.1
2400	30.5	184	22.0	183	20.6	182	19.1
2400	27.0	174	19.5	173	18.2	171	16.9
2400	24.0	163	17.1	161	16.0	160	14.9
2400	21.0	151	14.6	149	13.7	146	12.7
2300	28.0	174	19.3	173	18.1	172	16.7
2300	25.0	164	17.1	163	16.1	161	14.9
2300	22.0	152	14.9	152	13.9	150	12.9
2300	19.0	138	12.4	137	11.6	135	10.8
2200	21.0	147	13.5	146	12.6	144	11.7

Some (low) power settings may not be attainable due to low cylinder or oil temperatures depending on ambient conditions



SPEED and POWER SETTINGS vs ALTITUDE – (BEST ECONOMY)

Conditions:

Example:

Mixture: Best Economy (50° F Lean of Peak TIT)	Pressure Altitude: 12000 ft
Cruise Weight: 3100 LB	Propeller Speed: 2300 RPM
Altimeter: Set to 29.92	Manifold Pressure: 28.0 in HG
Configuration: Clean	Outside Air Temp: -8°C
	True Airspeed: 196 KTAS
	Fuel Flow: 15.6 GPH

25000 Ft. Pressure Altitude							
ΔISA: (OAT)		-30 -54	(-59)°C (-84)°F	0 0	(-28)°C (-30)°F	30 54	(2)°C (24)°F
RPM	MAP	KTAS	GPH	KTAS	GPH	KTAS	GPH
2500	30.5	235	19.4	236	18.3	234	17.0
2500	29.0	231	18.4	232	17.4	229	16.2
2500	26.0	222	16.7	222	15.7	219	14.6
2500	22.0	208	14.6	208	13.7	204	12.7
2400	30.5	232	18.8	233	17.7	230	16.5
2400	27.0	222	16.7	223	15.7	220	14.7
2400	24.0	213	15.1	213	14.2	209	13.2
2400	21.0	203	13.6	202	12.8	197	11.9
2300	28.0	221	16.5	221	15.6	218	14.5
2300	25.0	212	14.9	212	14.0	208	13.0
2300	22.0	201	13.3	200	12.5	196	11.6
2300	19.0	189	11.8	188	11.1	182	10.3
2200	21.0	192	12.0	190	11.3	185	10.5
24000 Ft. Pressure Altitude							
ΔISA: (OAT)		-30 -54	(-55)°C (-81)°F	0 0	(-24)°C (-27)°F	30 54	(6)°C (27)°F
RPM	MAP	KTAS	GPH	KTAS	GPH	KTAS	GPH
2500	30.5	234	19.4	234	18.3	232	17.0
2500	29.0	229	18.4	230	17.4	228	16.2
2500	26.0	220	16.7	221	15.7	217	14.6
2500	22.0	207	14.5	206	13.7	203	12.7
2400	30.5	231	18.8	231	17.7	228	16.5
2400	27.0	220	16.7	221	15.7	218	14.6
2400	24.0	211	15.1	211	14.2	207	13.2
2400	21.0	200	13.5	200	12.7	196	11.8
2300	28.0	220	16.6	219	15.6	216	14.5
2300	25.0	210	14.9	210	14.0	206	13.0
2300	22.0	200	13.3	198	12.5	194	11.6
2300	19.0	187	11.7	185	11.0	180	10.2
2200	21.0	191	12.0	189	11.3	184	10.5

Some (low) power settings may not be attainable due to low cylinder or oil temperatures depending on ambient conditions

Filled Speed & Fuel Flow table entries indicate conditions that may not be attainable without exceeding engine limitation Note 1 on Power Chart



SPEED and POWER SETTINGS vs ALTITUDE – (BEST ECONOMY)

22000 Ft. Pressure Altitude							
ΔISA: (OAT)		-30 -54	(-51)°C (-73)°F	0 0	(-20)°C (-19)°F	30 54	(10)°C (35)°F
RPM	MAP	KTAS	GPH	KTAS	GPH	KTAS	GPH
2500	30.5	230	19.4	231	18.2	228	17.0
2500	29.0	225	18.4	226	17.4	224	16.2
2500	26.0	216	16.7	217	15.7	214	14.7
2500	22.0	203	14.5	203	13.6	199	12.7
2400	30.5	227	18.7	227	17.6	225	16.5
2400	27.0	217	16.7	217	15.7	214	14.7
2400	24.0	208	15.1	207	14.2	204	13.2
2400	21.0	197	13.5	196	12.6	192	11.8
2300	28.0	216	16.6	216	15.6	213	14.5
2300	25.0	207	14.9	206	14.0	203	13.0
2300	22.0	196	13.2	195	12.4	191	11.6
2300	19.0	184	11.6	182	10.9	177	10.1
2200	21.0	187	11.9	186	11.2	181	10.4

20000 Ft. Pressure Altitude							
ΔISA: (OAT)		-30 -54	(-47)°C (-66)°F	0 0	(-16)°C (-12)°F	30 54	(14)°C (42)°F
RPM	MAP	KTAS	GPH	KTAS	GPH	KTAS	GPH
2500	30.5	226	19.3	227	18.2	224	17.0
2500	29.0	222	18.4	222	17.4	220	16.2
2500	26.0	213	16.7	213	15.8	210	14.7
2500	22.0	199	14.5	199	13.6	196	12.7
2400	30.5	223	18.7	224	17.6	221	16.4
2400	27.0	213	16.7	213	15.7	210	14.7
2400	24.0	204	15.1	203	14.2	200	13.2
2400	21.0	193	13.4	192	12.6	188	11.7
2300	28.0	213	16.6	213	15.6	210	14.6
2300	25.0	203	14.9	202	14.0	199	13.0
2300	22.0	192	13.2	192	12.4	188	11.5
2300	19.0	180	11.5	178	10.8	173	10.0
2200	21.0	184	11.9	182	11.1	178	10.3

Some (low) power settings may not be attainable due to low cylinder or oil temperatures depending on ambient conditions



SPEED and POWER SETTINGS vs ALTITUDE – (BEST ECONOMY)

18000 Ft. Pressure Altitude							
Δ ISA: (OAT)		-30 -54	(-51) ^{°C} (-59) ^{°F}	0 0	(-20) ^{°C} (-5) ^{°F}	30 54	(10) ^{°C} (49) ^{°F}
RPM	MAP	KTAS	GPH	KTAS	GPH	KTAS	GPH
2500	30.5	222	19.3	222	18.2	220	17.0
2500	29.0	217	18.4	218	17.4	216	16.2
2500	26.0	209	16.7	209	15.8	206	14.7
2500	22.0	196	14.5	195	13.6	192	12.7
2400	30.5	219	18.7	219	17.6	217	16.4
2400	27.0	209	16.7	209	15.8	206	14.7
2400	24.0	200	15.1	200	14.2	196	13.2
2400	21.0	190	13.5	189	12.6	185	11.8
2300	28.0	209	16.6	209	15.6	206	14.6
2300	25.0	199	14.9	199	14.0	196	13.0
2300	22.0	188	13.2	187	12.4	184	11.5
2300	19.0	176	11.4	175	10.7	170	10.0
2200	21.0	179	11.8	178	11.1	174	10.3

16000 Ft. Pressure Altitude							
Δ ISA: (OAT)		-30 -54	(-47) ^{°C} (-52) ^{°F}	0 0	(-16) ^{°C} (2) ^{°F}	30 54	(14) ^{°C} (56) ^{°F}
RPM	MAP	KTAS	GPH	KTAS	GPH	KTAS	GPH
2500	30.5	218	19.3	218	18.2	216	17.0
2500	29.0	214	18.5	214	17.4	212	16.3
2500	26.0	205	16.8	205	15.8	202	14.7
2500	22.0	192	14.5	191	13.6	188	12.7
2400	30.5	215	18.6	215	17.6	213	16.4
2400	27.0	205	16.8	205	15.8	203	14.7
2400	24.0	196	15.1	196	14.3	193	13.3
2400	21.0	186	13.5	185	12.7	181	11.8
2300	28.0	205	16.6	204	15.6	202	14.6
2300	25.0	195	14.9	195	14.0	192	13.1
2300	22.0	185	13.2	184	12.4	180	11.5
2300	19.0	173	11.4	171	10.7	167	9.9
2200	21.0	176	11.7	174	11.0	170	10.2

Some (low) power settings may not be attainable due to low cylinder or oil temperatures depending on ambient conditions



SPEED and POWER SETTINGS vs ALTITUDE – (BEST ECONOMY)

14000 Ft. Pressure Altitude							
ΔISA: (OAT)		-30 -54	(-43)°C (-45)°F	0 0	(-12)°C (9)°F	30 54	(18)°C (63)°F
RPM	MAP	KTAS	GPH	KTAS	GPH	KTAS	GPH
2500	30.5	214	19.3	214	18.2	212	17.0
2500	29.0	210	18.5	210	17.4	207	16.3
2500	26.0	201	16.8	201	15.9	198	14.8
2500	22.0	188	14.5	187	13.6	184	12.7
2400	30.5	211	18.6	211	17.6	208	16.4
2400	27.0	201	16.8	201	15.8	198	14.8
2400	24.0	192	15.2	192	14.3	189	13.3
2400	21.0	182	13.5	181	12.7	178	11.8
2300	28.0	200	16.6	200	15.6	198	14.6
2300	25.0	191	14.9	191	14.0	188	13.1
2300	22.0	181	13.2	180	12.4	176	11.5
2300	19.0	169	11.4	167	10.7	163	9.9
2200	21.0	172	11.7	170	11.0	166	10.2

12000 Ft. Pressure Altitude							
ΔISA: (OAT)		-30 -54	(-39)°C (-38)°F	0 0	(-8)°C (16)°F	30 54	(22)°C (70)°F
RPM	MAP	KTAS	GPH	KTAS	GPH	KTAS	GPH
2500	30.5	210	19.3	210	18.2	207	17.1
2500	29.0	206	18.5	205	17.5	203	16.3
2500	26.0	197	16.9	196	15.9	194	14.8
2500	22.0	183	14.5	182	13.7	179	12.7
2400	30.5	207	18.6	206	17.6	204	16.4
2400	27.0	197	16.8	197	15.9	194	14.8
2400	24.0	188	15.2	187	14.3	185	13.3
2400	21.0	178	13.5	177	12.7	173	11.8
2300	28.0	196	16.6	196	15.6	194	14.6
2300	25.0	187	14.9	186	14.0	184	13.1
2300	22.0	177	13.2	176	12.4	172	11.5
2300	19.0	164	11.3	163	10.6	159	9.9
2200	21.0	168	11.6	166	10.9	163	10.2

Some (low) power settings may not be attainable due to low cylinder or oil temperatures depending on ambient conditions



SPEED and POWER SETTINGS vs ALTITUDE – (BEST ECONOMY)

10000 Ft. Pressure Altitude							
Δ ISA: (OAT)		-30 -54	(-35) ^{°C} (-31) ^{°F}	0 0	(-4) ^{°C} (23) ^{°F}	30 54	(26) ^{°C} (77) ^{°F}
RPM	MAP	KTAS	GPH	KTAS	GPH	KTAS	GPH
2500	30.5	205	19.4	205	18.3	203	17.1
2500	29.0	201	18.6	201	17.5	199	16.4
2500	26.0	192	16.9	192	16.0	189	14.9
2500	22.0	179	14.6	178	13.7	175	12.8
2400	30.5	202	18.6	202	17.6	200	16.4
2400	27.0	193	16.8	193	15.9	190	14.8
2400	24.0	184	15.2	183	14.3	180	13.3
2400	21.0	174	13.5	172	12.7	169	11.8
2300	28.0	192	16.6	192	15.6	189	14.6
2300	25.0	183	14.9	182	14.1	179	13.1
2300	22.0	173	13.2	172	12.4	168	11.5
2300	19.0	160	11.3	158	10.6	154	9.9
2200	21.0	164	11.7	163	11.0	159	10.2

8000 Ft. Pressure Altitude							
Δ ISA: (OAT)		-30 -54	(-31) ^{°C} (-24) ^{°F}	0 0	(0) ^{°C} (30) ^{°F}	30 54	(30) ^{°C} (84) ^{°F}
RPM	MAP	KTAS	GPH	KTAS	GPH	KTAS	GPH
2500	30.5	201	19.4	201	18.4	199	17.2
2500	29.0	197	18.7	197	17.6	194	16.5
2500	26.0	188	17.0	188	16.1	185	15.0
2500	22.0	174	14.6	173	13.8	170	12.8
2400	30.5	198	18.7	197	17.6	195	16.5
2400	27.0	188	16.9	188	15.9	185	14.8
2400	24.0	179	15.2	178	14.3	175	13.3
2400	21.0	169	13.4	166	12.6	163	11.7
2300	28.0	188	16.6	187	15.6	185	14.6
2300	25.0	178	14.9	178	14.1	175	13.1
2300	22.0	168	13.2	167	12.4	164	11.5
2300	19.0	155	11.2	153	10.6	150	9.8
2200	21.0	160	11.7	159	11.0	155	10.2

Some (low) power settings may not be attainable due to low cylinder or oil temperatures depending on ambient conditions



SPEED and POWER SETTINGS vs ALTITUDE – (BEST ECONOMY)

6000 Ft. Pressure Altitude							
ΔISA: (OAT)		-30 -54	(-27)°C (-16)°F	0 0	(3)°C (38)°F	30 54	(33)°C (92)°F
RPM	MAP	KTAS	GPH	KTAS	GPH	KTAS	GPH
2500	30.5	196	19.5	196	18.4	194	17.2
2500	29.0	192	18.7	192	17.7	190	16.5
2500	26.0	183	17.1	183	16.1	180	15.1
2500	22.0	169	14.7	168	13.8	165	12.9
2400	30.5	193	18.7	193	17.7	191	16.5
2400	27.0	184	16.9	183	15.9	180	14.8
2400	24.0	174	15.1	173	14.2	170	13.3
2400	21.0	163	13.2	161	12.4	158	11.6
2300	28.0	183	16.6	183	15.7	180	14.6
2300	25.0	174	14.9	173	14.1	171	13.1
2300	22.0	163	13.1	162	12.3	159	11.5
2300	19.0	150	11.2	148	10.5	144	9.7
2200	21.0	156	11.7	154	11.0	151	10.3

4000 Ft. Pressure Altitude							
ΔISA: (OAT)		-30 -54	(-23)°C (-9)°F	0 0	(7)°C (45)°F	30 54	(37)°C (99)°F
RPM	MAP	KTAS	GPH	KTAS	GPH	KTAS	GPH
2500	30.5	192	19.6	191	18.5	189	17.3
2500	29.0	188	18.8	187	17.8	185	16.6
2500	26.0	179	17.2	178	16.2	175	15.1
2500	22.0	164	14.8	163	13.9	160	12.9
2400	30.5	189	18.8	188	17.7	186	16.6
2400	27.0	179	16.9	178	15.9	175	14.8
2400	24.0	169	15.0	167	14.2	164	13.2
2400	21.0	157	13.0	155	12.3	151	11.4
2300	28.0	179	16.6	178	15.7	176	14.6
2300	25.0	169	14.9	168	14.1	165	13.1
2300	22.0	158	13.1	156	12.3	153	11.4
2300	19.0	144	11.0	143	10.4	138	9.6
2200	21.0	151	11.8	150	11.1	146	10.3

Some (low) power settings may not be attainable due to low cylinder or oil temperatures depending on ambient conditions



SPEED and POWER SETTINGS vs ALTITUDE – (BEST ECONOMY)

2000 Ft. Pressure Altitude							
Δ ISA: (OAT)		-30 -54	(-19) [°] C (-2) [°] F	0 0	(11) [°] C (52) [°] F	30 54	(41) [°] C (106) [°] F
RPM	MAP	KTAS	GPH	KTAS	GPH	KTAS	GPH
2500	30.5	187	19.6	187	18.6	184	17.4
2500	29.0	183	18.9	182	17.9	180	16.7
2500	26.0	173	17.3	173	16.3	170	15.2
2500	22.0	159	14.8	158	14.0	155	13.0
2400	30.5	185	18.8	184	17.8	181	16.6
2400	27.0	174	16.8	173	15.9	170	14.8
2400	24.0	164	14.9	161	14.0	158	13.1
2400	21.0	151	12.8	148	12.0	144	11.2
2300	28.0	174	16.7	173	15.7	171	14.7
2300	25.0	164	14.9	163	14.0	160	13.1
2300	22.0	152	13.0	151	12.2	148	11.3
2300	19.0	138	10.8	136	10.2	131	9.5
2200	21.0	146	11.8	145	11.0	141	10.3

0 Ft. Pressure Altitude							
Δ ISA: (OAT)		-30 -54	(-15) [°] C (5) [°] F	0 0	(15) [°] C (59) [°] F	30 54	(45) [°] C (113) [°] F
RPM	MAP	KTAS	GPH	KTAS	GPH	KTAS	GPH
2500	30.5	182	19.7	181	18.6	179	17.4
2500	29.0	178	19.0	177	17.9	174	16.7
2500	26.0	168	17.4	168	16.4	165	15.3
2500	22.0	154	14.9	153	14.0	149	13.1
2400	30.5	180	18.9	179	17.8	176	16.7
2400	27.0	169	16.8	167	15.8	164	14.8
2400	24.0	157	14.8	155	13.9	152	12.9
2400	21.0	144	12.5	140	11.8	137	10.9
2300	28.0	169	16.7	168	15.7	166	14.7
2300	25.0	158	14.8	157	14.0	155	13.0
2300	22.0	147	12.8	145	12.0	142	11.2
2300	19.0	130	10.5	128	9.9	123	9.2
2200	21.0	141	11.6	139	11.0	136	10.2

Some (low) power settings may not be attainable due to low cylinder or oil temperatures depending on ambient conditions



RANGE AND ENDURANCE - (89 GAL - Best Power and Best Economy)

Associated Conditions for Range & Endurance Tables:

- Warmup, Taxi, Takeoff Fuel = 2 gallons
- Cruise Climb per Section V
- 500 fpm Descent per Section V
- 89 gallons of Useable Fuel
- Zero Wind
- Clean Configuration
- 45 minute reserve at Cruise Power Setting
- 3368 lb Ramp Weight
- Takeoff & Land at Sea Level

Example and Directions:

Lookup range and time according to desired power setting and ambient conditions. When ambient conditions fall between those shown use most conservative number (shorter range and longer time)

For 30.5 MAP, 2500 RPM, ISA +20, 14000 ft P. Alt, Best Power read: 704 NMI 3.43 Hours

If useable fuel is less than 89 gallons lookup fuel flow and speed corresponding to power setting in Section V cruise tables

Figure range reduction and subtract from range; figure time reduction and subtract from time:

For 10 gal less (79 gal useable):
 New zero wind range = $(\frac{217 \text{ kts}}{704 \text{ nmi}} - \frac{20.1 \text{ gph}}{108 \text{ nmi}}) \times 10 \text{ gal} = \frac{108 \text{ nmi}}{596 \text{ nmi}}$
Final time estimate = $\frac{3.43 \text{ hrs}}{217 \text{ kts}} = \frac{2.93 \text{ hours}}{217 \text{ kts}}$

Conservatively estimate wind enroute (e.g. maximum headwind, minimum tailwind) subtract [headwind x time] from range or add [tailwind x time] to range

For 20 knots maximum headwind enroute:
Final range estimate = $20 \text{ kts} \times 2.9 \text{ hours} = 59 \text{ nmi}$
Final range estimate = $596 \text{ nmi} - 59 \text{ nmi} = 537 \text{ nmi}$

Adjust power or altitude as required to make sure range estimate exceeds range requirement

Filled Range & Endurance table entries indicate conditions that may not be attainable without exceeding engine limitation
Note 1 on Power Chart

Some (low) power settings may not be attainable due to low cylinder or oil temperatures depending on ambient conditions



RANGE AND ENDURANCE - (89 GAL - Cruise MAP = 30.5 inHG / Cruise RPM = 2500)

Mixture = Best Power		Cruise MAP = 30.5 inHG Cruise RPM = 2500									
Press Alt Ft	STD OAT °C	ISA - 30°C		ISA - 15°C		ISA +0°C		ISA +15°C		ISA +30°C	
		NMI	HRS	NMI	HRS	NMI	HRS	NMI	HRS	NMI	HRS
0	15	566	3.05	589	3.17	613	3.31	639	3.46	666	3.63
4000	7	592	3.08	615	3.19	639	3.31	664	3.45	690	3.60
8000	-1	617	3.11	639	3.21	662	3.32	686	3.44	711	3.58
12000	-9	638	3.15	660	3.23	682	3.33	704	3.43	727	3.55
16000	-17	656	3.17	677	3.24	698	3.32	718	3.41	737	3.50
18000	-21	664	3.18	685	3.25	704	3.32	723	3.39	740	3.47
20000	-25	671	3.19	691	3.25	709	3.31	726	3.38	742	3.45
22000	-29	678	3.19	695	3.25	713	3.30	729	3.36	743	3.41
24000	-33	685	3.20	702	3.25	717	3.29	730	3.34	742	3.38
25000	-35	688	3.20	704	3.25	718	3.29	731	3.33	741	3.37

Mixture = Best Economy		Cruise MAP = 30.5 inHG Cruise RPM = 2500									
Press Alt Ft	STD OAT °C	ISA - 30°C		ISA - 15°C		ISA +0°C		ISA +15°C		ISA +30°C	
		NMI	HRS	NMI	HRS	NMI	HRS	NMI	HRS	NMI	HRS
0	15	669	3.70	691	3.82	714	3.96	738	4.11	763	4.29
4000	7	700	3.71	722	3.82	744	3.94	767	4.08	791	4.23
8000	-1	728	3.73	749	3.82	770	3.93	791	4.05	813	4.18
12000	-9	749	3.73	769	3.81	788	3.90	807	4.00	826	4.11
16000	-17	765	3.72	783	3.79	801	3.86	818	3.94	834	4.02
18000	-21	771	3.71	789	3.77	805	3.83	820	3.90	834	3.97
20000	-25	776	3.70	793	3.75	808	3.80	821	3.86	833	3.92
22000	-29	779	3.68	795	3.73	809	3.77	821	3.82	830	3.86
24000	-33	783	3.67	797	3.70	810	3.74	819	3.78	826	3.81
25000	-35	784	3.66	798	3.69	809	3.72	818	3.75	823	3.78

Some (low) power settings may not be attainable due to low cylinder or oil temperatures depending on ambient conditions



RANGE AND ENDURANCE - (89 GAL - Cruise MAP = 29 inHG / Cruise RPM = 2500)

Cruise MAP = 29 inHG Cruise RPM = 2500											
Mixture = Best Power		ISA -30°C		ISA -15°C		ISA +0°C		ISA +15°C		ISA +30°C	
Press Alt Ft	STD OAT °C	NMI	HRS	NMI	HRS	NMI	HRS	NMI	HRS	NMI	HRS
0	15	582	3.21	606	3.34	631	3.48	657	3.64	685	3.82
4000	7	611	3.24	634	3.35	659	3.48	684	3.62	711	3.78
8000	-1	637	3.27	660	3.37	684	3.49	708	3.61	733	3.75
12000	-9	660	3.30	682	3.39	705	3.49	727	3.60	750	3.72
16000	-17	680	3.32	701	3.40	721	3.48	742	3.57	761	3.67
18000	-21	688	3.33	709	3.40	729	3.47	747	3.55	765	3.64
20000	-25	696	3.33	716	3.40	734	3.46	752	3.53	768	3.60
22000	-29	703	3.34	721	3.39	739	3.45	755	3.51	769	3.57
24000	-33	710	3.34	727	3.39	743	3.44	757	3.49	768	3.53
25000	-35	713	3.35	730	3.39	744	3.43	757	3.48	767	3.51

Cruise MAP = 29 inHG Cruise RPM = 2500											
Mixture = Best Economy		ISA -30°C		ISA -15°C		ISA +0°C		ISA +15°C		ISA +30°C	
Press Alt Ft	STD OAT °C	NMI	HRS	NMI	HRS	NMI	HRS	NMI	HRS	NMI	HRS
0	15	684	3.87	707	4.00	730	4.15	754	4.31	779	4.49
4000	7	718	3.88	740	4.00	763	4.13	786	4.27	810	4.43
8000	-1	747	3.90	768	4.00	790	4.11	812	4.23	834	4.37
12000	-9	771	3.90	791	3.99	811	4.08	831	4.19	851	4.30
16000	-17	789	3.89	808	3.96	826	4.04	843	4.12	859	4.21
18000	-21	796	3.88	813	3.94	830	4.01	846	4.08	860	4.16
20000	-25	801	3.86	818	3.92	834	3.98	847	4.04	859	4.10
22000	-29	806	3.85	822	3.90	836	3.94	848	3.99	857	4.04
24000	-33	810	3.83	824	3.87	837	3.91	847	3.95	853	3.98
25000	-35	811	3.82	825	3.86	837	3.89	846	3.92	851	3.95

Some (low) power settings may not be attainable due to low cylinder or oil temperatures depending on ambient conditions



RANGE AND ENDURANCE - (89 GAL - Cruise MAP = 26 inHG / Cruise RPM = 2500)

Cruise MAP = 26 inHG Cruise RPM = 2500											
Mixture = Best Power						Mixture = Best Economy					
Press Alt Ft	STD OAT °C	ISA -30°C NMI	ISA -30°C HRS	ISA -15°C NMI	ISA -15°C HRS	ISA +0°C NMI	ISA +0°C HRS	ISA +15°C NMI	ISA +15°C HRS	ISA +30°C NMI	ISA +30°C HRS
0	15	620	3.60	645	3.74	671	3.90	698	4.07	726	4.26
4000	7	654	3.62	679	3.75	704	3.89	731	4.04	758	4.22
8000	-1	684	3.64	708	3.76	733	3.88	758	4.02	784	4.17
12000	-9	710	3.66	734	3.76	757	3.87	780	3.99	803	4.12
16000	-17	731	3.67	753	3.75	774	3.84	795	3.94	815	4.04
18000	-21	740	3.67	761	3.75	781	3.83	800	3.91	819	4.00
20000	-25	747	3.67	768	3.74	786	3.81	804	3.88	820	3.96
22000	-29	755	3.66	774	3.72	792	3.78	807	3.85	820	3.91
24000	-33	761	3.66	779	3.71	795	3.76	808	3.81	819	3.85
25000	-35	764	3.65	781	3.70	796	3.75	809	3.79	818	3.83

Cruise MAP = 26 inHG Cruise RPM = 2500											
Press Alt Ft	STD OAT °C	ISA -30°C NMI	ISA -30°C HRS	ISA -15°C NMI	ISA -15°C HRS	ISA +0°C NMI	ISA +0°C HRS	ISA +15°C NMI	ISA +15°C HRS	ISA +30°C NMI	ISA +30°C HRS
0	15	721	4.31	745	4.46	769	4.62	794	4.80	820	5.00
4000	7	760	4.31	783	4.44	807	4.59	830	4.75	855	4.92
8000	-1	794	4.32	817	4.43	839	4.56	862	4.69	884	4.85
12000	-9	821	4.31	842	4.41	863	4.51	883	4.63	903	4.76
16000	-17	841	4.29	861	4.37	880	4.45	897	4.54	913	4.64
18000	-21	849	4.27	868	4.34	885	4.41	901	4.49	914	4.58
20000	-25	855	4.25	873	4.31	889	4.37	903	4.44	915	4.51
22000	-29	860	4.22	877	4.27	891	4.33	902	4.38	911	4.43
24000	-33	864	4.19	879	4.24	891	4.28	900	4.32	906	4.35
25000	-35	866	4.18	880	4.22	891	4.25	899	4.29	903	4.31

Some (low) power settings may not be attainable due to low cylinder or oil temperatures depending on ambient conditions



RANGE AND ENDURANCE - (89 GAL - Cruise MAP = 22 inHG / Cruise RPM = 2500)

Mixture = Best Power		Cruise MAP = 22 inHG Cruise RPM = 2500											
Press Alt Ft	STD OAT °C	ISA -30°C		ISA -15°C		ISA +0°C		ISA +15°C		ISA +30°C			
		NMI	HRS	NMI	HRS	NMI	HRS	NMI	HRS	NMI	HRS		
0	15	688	4.32	715	4.49	742	4.67	770	4.87	799	5.10		
4000	7	727	4.33	753	4.47	780	4.64	808	4.82	836	5.02		
8000	-1	762	4.32	788	4.45	814	4.60	840	4.76	867	4.93		
12000	-9	790	4.30	815	4.42	839	4.54	864	4.68	888	4.82		
16000	-17	810	4.26	834	4.36	856	4.46	877	4.57	897	4.69		
18000	-21	817	4.24	841	4.33	861	4.42	881	4.51	899	4.61		
20000	-25	823	4.21	845	4.29	864	4.37	881	4.45	896	4.53		
22000	-29	829	4.18	849	4.24	866	4.31	882	4.38	895	4.45		
24000	-33	832	4.14	851	4.20	866	4.26	879	4.31	889	4.36		
25000	-35	834	4.13	851	4.18	865	4.22	877	4.27	885	4.31		

Mixture = Best Economy		Cruise MAP = 22 inHG Cruise RPM = 2500											
Press Alt Ft	STD OAT °C	ISA -30°C		ISA -15°C		ISA +0°C		ISA +15°C		ISA +30°C			
		NMI	HRS	NMI	HRS	NMI	HRS	NMI	HRS	NMI	HRS		
0	15	788	5.17	813	5.34	838	5.53	863	5.75	888	6.00		
4000	7	835	5.14	860	5.30	885	5.47	910	5.66	935	5.88		
8000	-1	873	5.11	897	5.24	920	5.39	944	5.56	967	5.74		
12000	-9	905	5.06	927	5.17	949	5.30	970	5.44	990	5.59		
16000	-17	926	4.98	946	5.07	965	5.18	983	5.29	998	5.40		
18000	-21	932	4.93	952	5.02	969	5.11	985	5.20	997	5.30		
20000	-25	936	4.88	956	4.95	971	5.03	984	5.11	994	5.19		
22000	-29	940	4.83	956	4.89	969	4.95	980	5.01	988	5.07		
24000	-33	941	4.77	955	4.82	967	4.86	975	4.91	978	4.95		
25000	-35	940	4.74	954	4.78	965	4.82	971	4.85	973	4.88		

Some (low) power settings may not be attainable due to low cylinder or oil temperatures depending on ambient conditions



RANGE AND ENDURANCE - (89 GAL - Cruise MAP = 30.5 inHG / Cruise RPM = 2400)

Cruise MAP = 30.5 inHG Cruise RPM = 2400											
Mixture = Best Power						Mixture = Best Economy					
Press Alt Ft	STD OAT °C	ISA -30°C NMI	ISA -30°C HRS	ISA -15°C NMI	ISA -15°C HRS	ISA +0°C NMI	ISA +0°C HRS	ISA +15°C NMI	ISA +15°C HRS	ISA +30°C NMI	ISA +30°C HRS
0	15	592	3.24	616	3.37	641	3.51	668	3.67	696	3.85
4000	7	617	3.26	641	3.38	666	3.50	692	3.65	719	3.80
8000	-1	640	3.28	663	3.38	687	3.50	711	3.62	736	3.76
12000	-9	660	3.29	682	3.38	704	3.48	727	3.59	750	3.70
16000	-17	677	3.30	698	3.38	718	3.46	739	3.55	759	3.64
18000	-21	684	3.30	705	3.37	725	3.44	743	3.52	761	3.61
20000	-25	690	3.30	710	3.36	728	3.43	745	3.50	761	3.57
22000	-29	696	3.30	714	3.36	731	3.41	747	3.47	761	3.53
24000	-33	703	3.30	719	3.35	735	3.40	749	3.45	760	3.49
25000	-35	705	3.31	721	3.35	736	3.39	749	3.43	759	3.47

Cruise MAP = 30.5 inHG Cruise RPM = 2400											
Press Alt Ft	STD OAT °C	ISA -30°C NMI	ISA -30°C HRS	ISA -15°C NMI	ISA -15°C HRS	ISA +0°C NMI	ISA +0°C HRS	ISA +15°C NMI	ISA +15°C HRS	ISA +30°C NMI	ISA +30°C HRS
0	15	696	3.90	719	4.03	742	4.17	767	4.33	793	4.52
4000	7	725	3.90	748	4.02	770	4.14	794	4.29	818	4.45
8000	-1	751	3.90	772	4.00	793	4.11	815	4.23	838	4.37
12000	-9	770	3.88	791	3.97	811	4.06	830	4.16	850	4.28
16000	-17	785	3.85	804	3.92	822	4.00	838	4.08	854	4.17
18000	-21	790	3.84	808	3.90	824	3.97	840	4.04	854	4.11
20000	-25	794	3.82	811	3.87	827	3.93	841	3.99	852	4.05
22000	-29	797	3.80	813	3.84	827	3.89	838	3.94	848	3.98
24000	-33	800	3.78	813	3.81	826	3.85	835	3.89	842	3.92
25000	-35	801	3.76	813	3.80	825	3.83	834	3.86	839	3.89

Some (low) power settings may not be attainable due to low cylinder or oil temperatures depending on ambient conditions



RANGE AND ENDURANCE - (89 GAL - Cruise MAP = 27 inHG / Cruise RPM = 2400)

Mixture = Best Power		Cruise MAP = 27 inHG Cruise RPM = 2400											
Press Alt Ft	STD OAT °C	ISA -30°C		ISA -15°C		ISA +0°C		ISA +15°C		ISA +30°C			
		NMI	HRS	NMI	HRS	NMI	HRS	NMI	HRS	NMI	HRS		
0	15	647	3.77	673	3.92	699	4.08	727	4.26	756	4.46		
4000	7	671	3.72	696	3.85	722	3.99	749	4.15	777	4.33		
8000	-1	693	3.69	718	3.81	743	3.93	768	4.07	794	4.23		
12000	-9	714	3.68	737	3.78	761	3.89	784	4.01	807	4.14		
16000	-17	733	3.68	755	3.77	776	3.86	797	3.95	818	4.06		
18000	-21	743	3.68	764	3.76	784	3.84	803	3.93	821	4.02		
20000	-25	751	3.68	771	3.75	790	3.82	807	3.90	823	3.97		
22000	-29	757	3.68	777	3.74	795	3.80	810	3.86	824	3.92		
24000	-33	762	3.67	781	3.72	796	3.77	810	3.82	820	3.87		
25000	-35	766	3.66	782	3.71	796	3.75	809	3.79	818	3.83		

Mixture = Best Economy		Cruise MAP = 27 inHG Cruise RPM = 2400											
Press Alt Ft	STD OAT °C	ISA -30°C		ISA -15°C		ISA +0°C		ISA +15°C		ISA +30°C			
		NMI	HRS	NMI	HRS	NMI	HRS	NMI	HRS	NMI	HRS		
0	15	748	4.49	773	4.64	797	4.81	823	5.00	850	5.21		
4000	7	778	4.41	802	4.55	826	4.69	850	4.86	875	5.04		
8000	-1	803	4.36	825	4.47	848	4.60	871	4.74	894	4.89		
12000	-9	825	4.32	846	4.42	867	4.52	887	4.64	908	4.77		
16000	-17	843	4.29	863	4.37	881	4.45	899	4.54	916	4.64		
18000	-21	850	4.27	869	4.34	886	4.42	902	4.49	916	4.58		
20000	-25	857	4.25	874	4.31	890	4.37	904	4.44	915	4.51		
22000	-29	862	4.22	878	4.28	892	4.33	904	4.38	912	4.43		
24000	-33	864	4.19	880	4.23	892	4.28	901	4.32	907	4.35		
25000	-35	865	4.17	880	4.21	891	4.25	899	4.28	903	4.30		

Some (low) power settings may not be attainable due to low cylinder or oil temperatures depending on ambient conditions



RANGE AND ENDURANCE - (89 GAL - Cruise MAP = 24 inHG / Cruise RPM = 2400)

Cruise MAP = 24 inHG Cruise RPM = 2400													
Mixture = Best Power		ISA -30°C		ISA -15°C		ISA +0°C		ISA +15°C		ISA +30°C			
Press Alt Ft	STD OAT °C	NMI	HRS	NMI	HRS	NMI	HRS	NMI	HRS	NMI	HRS	NMI	HRS
0	15	707	4.40	734	4.57	762	4.75	791	4.96	822	5.19		
4000	7	729	4.25	755	4.40	782	4.56	810	4.74	839	4.94		
8000	-1	749	4.16	774	4.29	800	4.43	826	4.58	853	4.75		
12000	-9	770	4.11	794	4.22	818	4.34	842	4.47	866	4.61		
16000	-17	789	4.09	812	4.18	834	4.28	855	4.38	876	4.50		
18000	-21	799	4.08	820	4.16	841	4.25	860	4.34	879	4.44		
20000	-25	806	4.07	827	4.14	846	4.22	863	4.30	879	4.38		
22000	-29	813	4.05	832	4.11	850	4.18	865	4.25	878	4.31		
24000	-33	817	4.02	835	4.08	850	4.13	863	4.18	873	4.23		
25000	-35	817	4.00	835	4.05	849	4.10	861	4.14	869	4.18		

Cruise MAP = 24 inHG Cruise RPM = 2400													
Mixture = Best Economy		ISA -30°C		ISA -15°C		ISA +0°C		ISA +15°C		ISA +30°C			
Press Alt Ft	STD OAT °C	NMI	HRS	NMI	HRS	NMI	HRS	NMI	HRS	NMI	HRS	NMI	HRS
0	15	812	5.23	838	5.41	864	5.61	890	5.83	917	6.07		
4000	7	835	5.03	860	5.18	885	5.35	910	5.54	936	5.75		
8000	-1	860	4.89	884	5.02	908	5.17	931	5.33	954	5.50		
12000	-9	881	4.81	904	4.92	925	5.04	946	5.17	967	5.31		
16000	-17	901	4.75	921	4.84	940	4.94	958	5.04	975	5.15		
18000	-21	909	4.73	928	4.81	946	4.89	962	4.98	975	5.07		
20000	-25	916	4.70	934	4.76	950	4.84	964	4.91	975	4.99		
22000	-29	920	4.66	936	4.71	950	4.77	961	4.83	969	4.89		
24000	-33	921	4.60	936	4.65	948	4.70	956	4.74	961	4.77		
25000	-35	921	4.57	934	4.61	945	4.65	952	4.68	954	4.71		

Some (low) power settings may not be attainable due to low cylinder or oil temperatures depending on ambient conditions



RANGE AND ENDURANCE - (89 GAL - Cruise MAP = 21 inHG / Cruise RPM = 2400)

Cruise MAP = 21 inHG Cruise RPM = 2400											
Mixture = Best Power						Cruise MAP = 21 inHG Cruise RPM = 2400					
Press Alt Ft	STD OAT °C	ISA -30°C		ISA -15°C		ISA +0°C		ISA +15°C		ISA +30°C	
		NMI	HRS	NMI	HRS	NMI	HRS	NMI	HRS	NMI	HRS
0	15	783	5.31	812	5.50	841	5.72	870	5.96	901	6.23
4000	7	799	4.98	827	5.15	855	5.34	884	5.54	914	5.77
8000	-1	816	4.77	843	4.92	870	5.08	897	5.25	924	5.44
12000	-9	834	4.66	860	4.78	885	4.91	909	5.06	934	5.22
16000	-17	854	4.59	877	4.70	900	4.81	921	4.92	942	5.05
18000	-21	862	4.57	884	4.66	904	4.76	924	4.86	942	4.97
20000	-25	868	4.54	889	4.62	909	4.70	926	4.79	941	4.88
22000	-29	873	4.50	892	4.57	910	4.64	925	4.71	937	4.78
24000	-33	872	4.43	890	4.49	905	4.55	918	4.60	926	4.65
25000	-35	870	4.39	887	4.44	901	4.49	912	4.54	919	4.58

Cruise MAP = 21 inHG Cruise RPM = 2400											
Mixture = Best Economy						Cruise MAP = 21 inHG Cruise RPM = 2400					
Press Alt Ft	STD OAT °C	ISA -30°C		ISA -15°C		ISA +0°C		ISA +15°C		ISA +30°C	
		NMI	HRS	NMI	HRS	NMI	HRS	NMI	HRS	NMI	HRS
0	15	891	6.35	917	6.56	943	6.80	968	7.06	990	7.36
4000	7	913	5.91	939	6.09	965	6.29	990	6.51	1015	6.76
8000	-1	930	5.63	954	5.78	979	5.94	1002	6.13	1026	6.33
12000	-9	951	5.46	975	5.58	997	5.72	1018	5.87	1037	6.03
16000	-17	969	5.35	990	5.45	1010	5.56	1027	5.68	1042	5.80
18000	-21	977	5.30	997	5.39	1015	5.49	1030	5.59	1042	5.70
20000	-25	983	5.25	1001	5.33	1016	5.41	1029	5.50	1038	5.58
22000	-29	984	5.18	999	5.25	1013	5.32	1023	5.38	1029	5.44
24000	-33	982	5.09	996	5.14	1008	5.19	1015	5.24	1017	5.28
25000	-35	978	5.03	991	5.08	1001	5.12	1007	5.15	1007	5.18

Some (low) power settings may not be attainable due to low cylinder or oil temperatures depending on ambient conditions



RANGE AND ENDURANCE - (89 GAL - Cruise MAP = 28 inHG / Cruise RPM = 2300)

Cruise MAP = 28 inHG Cruise RPM = 2300											
Mixture = Best Power						Mixture = Best Economy					
Press Alt Ft	STD OAT °C	ISA -30°C NMI	ISA -30°C HRS	ISA -15°C NMI	ISA -15°C HRS	ISA +0°C NMI	ISA +0°C HRS	ISA +15°C NMI	ISA +15°C HRS	ISA +30°C NMI	ISA +30°C HRS
0	15	658	3.81	684	3.96	710	4.12	739	4.30	768	4.50
4000	7	683	3.79	708	3.92	735	4.07	762	4.23	790	4.41
8000	-1	706	3.78	730	3.90	756	4.02	781	4.17	807	4.32
12000	-9	726	3.76	750	3.87	773	3.98	797	4.10	821	4.23
16000	-17	744	3.74	766	3.83	787	3.92	808	4.02	828	4.13
18000	-21	751	3.73	773	3.81	793	3.89	812	3.98	831	4.07
20000	-25	758	3.73	778	3.79	796	3.87	814	3.94	830	4.02
22000	-29	764	3.72	782	3.78	800	3.84	816	3.90	829	3.97
24000	-33	770	3.72	788	3.77	804	3.82	818	3.87	829	3.91
25000	-35	773	3.72	791	3.76	806	3.81	818	3.85	827	3.89

Cruise MAP = 28 inHG Cruise RPM = 2300											
Press Alt Ft	STD OAT °C	ISA -30°C NMI	ISA -30°C HRS	ISA -15°C NMI	ISA -15°C HRS	ISA +0°C NMI	ISA +0°C HRS	ISA +15°C NMI	ISA +15°C HRS	ISA +30°C NMI	ISA +30°C HRS
0	15	760	4.52	784	4.67	810	4.84	836	5.02	863	5.24
4000	7	790	4.48	813	4.61	838	4.76	863	4.92	889	5.11
8000	-1	816	4.44	839	4.56	862	4.68	885	4.83	909	4.98
12000	-9	836	4.40	858	4.49	879	4.60	900	4.72	920	4.85
16000	-17	851	4.34	871	4.42	890	4.51	907	4.60	923	4.70
18000	-21	857	4.31	876	4.38	893	4.46	909	4.54	923	4.62
20000	-25	862	4.28	880	4.34	896	4.41	910	4.48	921	4.54
22000	-29	867	4.25	882	4.31	896	4.36	908	4.41	917	4.47
24000	-33	870	4.23	884	4.27	896	4.32	905	4.35	911	4.39
25000	-35	871	4.22	885	4.26	896	4.29	904	4.33	908	4.35

Some (low) power settings may not be attainable due to low cylinder or oil temperatures depending on ambient conditions



RANGE AND ENDURANCE - (89 GAL - Cruise MAP = 25 inHG / Cruise RPM = 2300)

Cruise MAP = 25 inHG Cruise RPM = 2300											
Mixture = Best Power		ISA -30°C		ISA -15°C		ISA +0°C		ISA +15°C		ISA +30°C	
Press Alt Ft	STD OAT °C	NMI	HRS	NMI	HRS	NMI	HRS	NMI	HRS	NMI	HRS
0	15	714	4.39	741	4.56	769	4.74	799	4.95	829	5.18
4000	7	740	4.30	767	4.45	794	4.61	822	4.79	852	5.00
8000	-1	764	4.25	789	4.38	816	4.53	842	4.68	869	4.86
12000	-9	784	4.22	809	4.33	834	4.45	858	4.58	882	4.73
16000	-17	803	4.18	825	4.27	848	4.37	869	4.48	890	4.60
18000	-21	810	4.16	832	4.24	853	4.33	873	4.43	891	4.53
20000	-25	818	4.14	838	4.21	857	4.29	875	4.37	891	4.45
22000	-29	823	4.11	843	4.18	861	4.25	876	4.31	889	4.38
24000	-33	828	4.09	846	4.15	861	4.20	874	4.25	884	4.30
25000	-35	830	4.08	846	4.13	861	4.18	872	4.22	880	4.26

Cruise MAP = 25 inHG Cruise RPM = 2300											
Mixture = Best Economy		ISA -30°C		ISA -15°C		ISA +0°C		ISA +15°C		ISA +30°C	
Press Alt Ft	STD OAT °C	NMI	HRS	NMI	HRS	NMI	HRS	NMI	HRS	NMI	HRS
0	15	816	5.19	842	5.36	869	5.56	896	5.77	924	6.02
4000	7	847	5.06	872	5.22	898	5.39	924	5.57	950	5.78
8000	-1	874	4.98	898	5.11	922	5.26	946	5.42	970	5.60
12000	-9	897	4.91	919	5.02	941	5.14	963	5.28	983	5.42
16000	-17	914	4.84	935	4.93	954	5.03	972	5.13	988	5.24
18000	-21	920	4.80	939	4.88	957	4.96	973	5.05	987	5.15
20000	-25	924	4.75	942	4.82	958	4.90	972	4.97	983	5.05
22000	-29	929	4.71	945	4.77	959	4.83	970	4.89	978	4.94
24000	-33	931	4.66	946	4.71	958	4.76	966	4.80	971	4.84
25000	-35	932	4.64	946	4.68	957	4.72	964	4.75	966	4.78

Some (low) power settings may not be attainable due to low cylinder or oil temperatures depending on ambient conditions



RANGE AND ENDURANCE - (89 GAL - Cruise MAP = 22 inHG / Cruise RPM = 2300)

Cruise MAP = 22 inHG Cruise RPM = 2300											
Mixture = Best Power		ISA -30°C		ISA -15°C		ISA +0°C		ISA +15°C		ISA +30°C	
Press Alt Ft	STD OAT °C	NMI	HRS	NMI	HRS	NMI	HRS	NMI	HRS	NMI	HRS
0	15	787	5.20	815	5.40	845	5.61	875	5.85	907	6.11
4000	7	809	5.00	838	5.17	866	5.36	895	5.56	925	5.79
8000	-1	834	4.88	861	5.03	888	5.19	916	5.37	944	5.57
12000	-9	855	4.80	881	4.93	906	5.07	931	5.21	956	5.38
16000	-17	872	4.73	895	4.83	918	4.94	940	5.06	960	5.19
18000	-21	879	4.68	902	4.78	923	4.88	943	4.98	961	5.09
20000	-25	884	4.64	905	4.72	924	4.81	941	4.90	956	4.99
22000	-29	886	4.59	906	4.66	923	4.73	938	4.80	950	4.87
24000	-33	888	4.53	906	4.59	921	4.65	933	4.70	941	4.75
25000	-35	887	4.50	904	4.55	919	4.60	929	4.65	936	4.69

Cruise MAP = 22 inHG Cruise RPM = 2300											
Mixture = Best Economy		ISA -30°C		ISA -15°C		ISA +0°C		ISA +15°C		ISA +30°C	
Press Alt Ft	STD OAT °C	NMI	HRS	NMI	HRS	NMI	HRS	NMI	HRS	NMI	HRS
0	15	895	6.17	922	6.37	948	6.60	975	6.86	1001	7.15
4000	7	920	5.89	946	6.07	973	6.27	999	6.49	1026	6.73
8000	-1	948	5.72	974	5.88	998	6.05	1023	6.23	1046	6.44
12000	-9	971	5.60	995	5.73	1017	5.87	1038	6.02	1059	6.19
16000	-17	989	5.48	1010	5.58	1029	5.70	1047	5.82	1062	5.94
18000	-21	992	5.41	1012	5.51	1029	5.60	1045	5.71	1058	5.81
20000	-25	996	5.34	1015	5.42	1030	5.51	1043	5.59	1052	5.68
22000	-29	997	5.27	1013	5.33	1027	5.40	1037	5.47	1043	5.53
24000	-33	995	5.18	1009	5.23	1020	5.28	1027	5.33	1029	5.37
25000	-35	993	5.13	1006	5.18	1016	5.22	1021	5.26	1021	5.29

Some (low) power settings may not be attainable due to low cylinder or oil temperatures depending on ambient conditions



RANGE AND ENDURANCE - (89 GAL - Cruise MAP = 19 inHG / Cruise RPM = 2300)

Cruise MAP = 19 inHG Cruise RPM = 2300											
Mixture = Best Power		ISA -30°C		ISA -15°C		ISA +0°C		ISA +15°C		ISA +30°C	
Press Alt Ft	STD OAT °C	NMI	HRS	NMI	HRS	NMI	HRS	NMI	HRS	NMI	HRS
0	15	876	6.41	906	6.64	936	6.90	966	7.18	997	7.50
4000	7	898	6.00	928	6.19	957	6.41	988	6.65	1018	6.92
8000	-1	920	5.76	948	5.93	977	6.11	1004	6.32	1032	6.55
12000	-9	942	5.59	969	5.74	995	5.90	1020	6.07	1044	6.25
16000	-17	955	5.45	980	5.57	1003	5.70	1024	5.83	1043	5.98
18000	-21	960	5.37	983	5.48	1004	5.59	1023	5.71	1039	5.83
20000	-25	960	5.28	981	5.37	1000	5.47	1016	5.57	1030	5.67
22000	-29	958	5.18	978	5.26	995	5.34	1009	5.42	1018	5.49
24000	-33	953	5.06	970	5.13	984	5.19	995	5.25	1001	5.30
25000	-35	948	5.00	964	5.06	977	5.11	986	5.16	990	5.20

Cruise MAP = 19 inHG Cruise RPM = 2300											
Mixture = Best Economy		ISA -30°C		ISA -15°C		ISA +0°C		ISA +15°C		ISA +30°C	
Press Alt Ft	STD OAT °C	NMI	HRS	NMI	HRS	NMI	HRS	NMI	HRS	NMI	HRS
0	15	987	7.69	1012	7.95	1036	8.24	1058	8.56	1077	8.91
4000	7	1016	7.12	1043	7.34	1069	7.58	1093	7.84	1115	8.14
8000	-1	1042	6.79	1068	6.97	1093	7.18	1117	7.40	1139	7.64
12000	-9	1065	6.56	1089	6.71	1111	6.88	1131	7.06	1149	7.26
16000	-17	1079	6.36	1100	6.48	1119	6.61	1135	6.75	1148	6.90
18000	-21	1081	6.25	1100	6.35	1117	6.47	1130	6.59	1140	6.71
20000	-25	1080	6.12	1098	6.22	1112	6.31	1122	6.41	1127	6.51
22000	-29	1076	5.99	1091	6.06	1102	6.14	1109	6.21	1111	6.29
24000	-33	1065	5.83	1079	5.89	1088	5.95	1092	6.00	1089	6.04
25000	-35	1059	5.74	1072	5.80	1080	5.84	1082	5.88	1077	5.91

Some (low) power settings may not be attainable due to low cylinder or oil temperatures depending on ambient conditions



RANGE AND ENDURANCE - (89 GAL - Cruise MAP = 21 inHG / Cruise RPM = 2200)

Cruise MAP = 21 inHG Cruise RPM = 2200											
Mixture = Best Power		ISA -30°C		ISA -15°C		ISA +0°C		ISA +15°C		ISA +30°C	
Press Alt Ft	STD OAT °C	NMI	HRS	NMI	HRS	NMI	HRS	NMI	HRS	NMI	HRS
0	15	846	5.81	876	6.02	907	6.26	938	6.52	971	6.81
4000	7	876	5.64	906	5.82	936	6.03	966	6.26	996	6.51
8000	-1	910	5.57	938	5.73	966	5.91	995	6.11	1023	6.33
12000	-9	935	5.48	962	5.63	988	5.78	1013	5.95	1038	6.13
16000	-17	948	5.35	972	5.47	996	5.60	1017	5.73	1037	5.87
18000	-21	952	5.27	975	5.37	996	5.48	1015	5.60	1033	5.72
20000	-25	951	5.17	972	5.26	992	5.36	1008	5.46	1022	5.55
22000	-29	949	5.08	969	5.16	986	5.24	1000	5.31	1010	5.39
24000	-33	948	4.99	966	5.06	981	5.12	992	5.18	998	5.23
25000	-35	947	4.95	964	5.01	978	5.07	987	5.11	991	5.15

Cruise MAP = 21 inHG Cruise RPM = 2200											
Mixture = Best Economy		ISA -30°C		ISA -15°C		ISA +0°C		ISA +15°C		ISA +30°C	
Press Alt Ft	STD OAT °C	NMI	HRS	NMI	HRS	NMI	HRS	NMI	HRS	NMI	HRS
0	15	957	6.85	985	7.08	1012	7.34	1040	7.63	1065	7.95
4000	7	989	6.61	1016	6.81	1044	7.03	1071	7.28	1097	7.55
8000	-1	1027	6.50	1053	6.67	1079	6.86	1103	7.07	1126	7.31
12000	-9	1054	6.37	1078	6.52	1101	6.68	1123	6.86	1142	7.05
16000	-17	1068	6.19	1089	6.31	1108	6.43	1125	6.57	1138	6.71
18000	-21	1067	6.07	1086	6.17	1104	6.28	1118	6.40	1129	6.52
20000	-25	1066	5.94	1084	6.03	1099	6.12	1111	6.22	1118	6.31
22000	-29	1062	5.82	1078	5.89	1090	5.96	1099	6.04	1102	6.11
24000	-33	1056	5.70	1070	5.76	1080	5.81	1085	5.86	1084	5.91
25000	-35	1054	5.65	1066	5.70	1075	5.74	1078	5.78	1074	5.81

Some (low) power settings may not be attainable due to low cylinder or oil temperatures depending on ambient conditions



RANGE AND ENDURANCE - (89 GAL - Cruise MAP = 21 inHG / Cruise RPM = 2100)

Cruise MAP = 21 inHG Cruise RPM = 2100											
Mixture = Best Power		ISA -30°C		ISA -15°C		ISA +0°C		ISA +15°C		ISA +30°C	
Press Alt Ft	STD OAT °C	NMI	HRS	NMI	HRS	NMI	HRS	NMI	HRS	NMI	HRS
0	15	877	6.10	908	6.32	939	6.56	972	6.84	1005	7.14
4000	7	919	6.03	949	6.22	979	6.44	1010	6.69	1041	6.96
8000	-1	963	6.06	992	6.24	1021	6.44	1050	6.65	1079	6.89
12000	-9	995	6.02	1023	6.17	1049	6.34	1075	6.52	1099	6.72
16000	-17	1005	5.83	1031	5.96	1054	6.10	1076	6.24	1095	6.39
18000	-21	1003	5.70	1026	5.82	1048	5.93	1067	6.06	1083	6.19
20000	-25	999	5.57	1020	5.66	1039	5.76	1055	5.87	1068	5.97
22000	-29	994	5.44	1014	5.52	1030	5.60	1044	5.68	1053	5.76
24000	-33	992	5.34	1010	5.40	1023	5.47	1033	5.53	1038	5.58
25000	-35	992	5.30	1008	5.36	1020	5.42	1027	5.47	1029	5.51

Cruise MAP = 21 inHG Cruise RPM = 2100											
Mixture = Best Economy		ISA -30°C		ISA -15°C		ISA +0°C		ISA +15°C		ISA +30°C	
Press Alt Ft	STD OAT °C	NMI	HRS	NMI	HRS	NMI	HRS	NMI	HRS	NMI	HRS
0	15	987	7.12	1015	7.36	1044	7.62	1073	7.92	1101	8.25
4000	7	1031	7.01	1059	7.22	1087	7.45	1114	7.71	1140	8.00
8000	-1	1082	7.02	1109	7.21	1135	7.42	1159	7.65	1181	7.90
12000	-9	1114	6.95	1138	7.11	1161	7.28	1182	7.48	1201	7.68
16000	-17	1122	6.70	1144	6.83	1163	6.97	1179	7.12	1192	7.28
18000	-21	1119	6.54	1139	6.65	1156	6.77	1170	6.89	1179	7.02
20000	-25	1112	6.36	1130	6.45	1144	6.55	1155	6.65	1161	6.75
22000	-29	1104	6.19	1119	6.27	1131	6.35	1138	6.43	1139	6.50
24000	-33	1098	6.06	1111	6.12	1120	6.18	1123	6.23	1119	6.28
25000	-35	1097	6.01	1109	6.07	1116	6.12	1117	6.16	1110	6.19

Some (low) power settings may not be attainable due to low cylinder or oil temperatures depending on ambient conditions



RANGE AND ENDURANCE - (100 GAL - Best Power and Best Economy)

Associated Conditions for Range & Endurance Tables:

- Warmup, Taxi, Takeoff Fuel = 2 gallons
- Cruise Climb per Section V
- 500 fpm Descent per Section V
- 100 gallons of Useable Fuel
- Zero Wind
- Clean Configuration
- 45 minute reserve at Cruise Power Setting
- 3368 lb Ramp Weight
- Takeoff & Land at Sea Level

Example and Directions:

Lookup range and time according to desired power setting and ambient conditions.
When ambient conditions fall between those shown use most conservative number (shorter range and longer time)
For 30.5 MAP, 2500 RPM, ISA +20, 14000 ft P. Alt, Best Power read: 817 NMI 4.09 Hours

If useable fuel is less than 89 gallons lookup fuel flow and speed corresponding to power setting in Section V cruise tables

Figure range reduction and subtract from range; figure time reduction and subtract from time:

For 10 gal less (90 gal useable): (217 kts/ 20.1 gph) x 10 gal = 108 nmi
 New zero wind range = 817 nmi - 108 nmi = 709 nmi
Final time estimate = 4.09 hrs - (108 nmi / 217 kts) = 3.59 hours

Conservatively estimate wind enroute (e.g. maximum headwind, minimum tailwind) subtract [headwind x time] from range or add [tailwind x time] to range

For 20 knots maximum headwind enroute: 20 kts x 3.59 hours = 72 nmi
Final range estimate = 709 nmi - 72 nmi = 637 nmi

Adjust power or altitude as required to make sure range estimate exceeds range requirement

Filled Range & Endurance table entries indicate conditions that may not be attainable without exceeding engine limitation
Note 1 on Power Chart

Some (low) power settings may not be attainable due to low cylinder or oil temperatures depending on ambient conditions



RANGE AND ENDURANCE - (100 GAL - Cruise MAP = 30.5 inHG / Cruise RPM = 2500)

Cruise MAP = 30.5 inHG Cruise RPM = 2500											
Mixture = Best Power						Cruise MAP = 30.5 inHG Cruise RPM = 2500					
Press Alt Ft	STD OAT °C	ISA -30°C NMI	ISA -30°C HRS	ISA -15°C NMI	ISA -15°C HRS	ISA +0°C NMI	ISA +0°C HRS	ISA +15°C NMI	ISA +15°C HRS	ISA +30°C NMI	ISA +30°C HRS
0	15	655	3.53	681	3.67	708	3.82	737	3.99	768	4.19
4000	7	685	3.56	711	3.68	738	3.82	767	3.98	797	4.15
8000	-1	714	3.59	740	3.71	766	3.83	794	3.97	823	4.13
12000	-9	739	3.62	765	3.72	790	3.84	817	3.96	843	4.09
16000	-17	761	3.64	786	3.73	810	3.83	834	3.93	857	4.05
18000	-21	770	3.65	795	3.73	818	3.82	841	3.92	863	4.02
20000	-25	779	3.65	802	3.73	825	3.81	846	3.90	866	3.99
22000	-29	787	3.66	809	3.73	831	3.80	850	3.88	869	3.95
24000	-33	796	3.66	817	3.73	835	3.79	853	3.85	869	3.92
25000	-35	799	3.67	820	3.73	838	3.79	855	3.84	869	3.90

Cruise MAP = 30.5 inHG Cruise RPM = 2500											
Mixture = Best Economy						Cruise MAP = 30.5 inHG Cruise RPM = 2500					
Press Alt Ft	STD OAT °C	ISA -30°C NMI	ISA -30°C HRS	ISA -15°C NMI	ISA -15°C HRS	ISA +0°C NMI	ISA +0°C HRS	ISA +15°C NMI	ISA +15°C HRS	ISA +30°C NMI	ISA +30°C HRS
0	15	771	4.26	796	4.40	822	4.55	848	4.73	876	4.92
4000	7	808	4.27	832	4.40	857	4.53	883	4.69	910	4.86
8000	-1	840	4.29	864	4.40	888	4.52	913	4.66	938	4.81
12000	-9	865	4.29	888	4.39	911	4.49	934	4.61	957	4.74
16000	-17	885	4.27	907	4.36	928	4.45	949	4.55	968	4.65
18000	-21	893	4.26	914	4.34	934	4.42	953	4.51	971	4.60
20000	-25	899	4.24	920	4.31	939	4.38	956	4.46	972	4.54
22000	-29	905	4.23	924	4.29	942	4.35	957	4.41	971	4.48
24000	-33	909	4.21	927	4.26	944	4.32	958	4.37	969	4.42
25000	-35	911	4.20	929	4.25	944	4.30	956	4.35	966	4.39

Some (low) power settings may not be attainable due to low cylinder or oil temperatures depending on ambient conditions



RANGE AND ENDURANCE - (100 GAL - Cruise MAP = 29 inHG / Cruise RPM = 2500)

Cruise MAP = 29 inHG Cruise RPM = 2500											
Mixture = Best Power						Cruise MAP = 29 inHG Cruise RPM = 2500					
Press Alt Ft	STD OAT °C	ISA -30°C		ISA -15°C		ISA +0°C		ISA +15°C		ISA +30°C	
		NMI	HRS	NMI	HRS	NMI	HRS	NMI	HRS	NMI	HRS
0	15	673	3.71	700	3.86	728	4.02	757	4.19	788	4.39
4000	7	706	3.74	733	3.87	760	4.01	789	4.17	820	4.35
8000	-1	737	3.77	764	3.89	791	4.02	819	4.16	848	4.33
12000	-9	764	3.80	790	3.90	816	4.02	842	4.15	869	4.29
16000	-17	787	3.82	812	3.91	837	4.01	861	4.12	885	4.24
18000	-21	797	3.82	822	3.91	846	4.00	869	4.10	891	4.20
20000	-25	807	3.83	831	3.91	854	3.99	875	4.08	895	4.17
22000	-29	816	3.83	838	3.90	860	3.98	880	4.05	899	4.13
24000	-33	825	3.83	846	3.90	866	3.96	884	4.03	900	4.10
25000	-35	829	3.84	850	3.90	868	3.96	885	4.02	899	4.08

Cruise MAP = 29 inHG Cruise RPM = 2500											
Mixture = Best Economy						Cruise MAP = 29 inHG Cruise RPM = 2500					
Press Alt Ft	STD OAT °C	ISA -30°C		ISA -15°C		ISA +0°C		ISA +15°C		ISA +30°C	
		NMI	HRS	NMI	HRS	NMI	HRS	NMI	HRS	NMI	HRS
0	15	788	4.46	813	4.60	839	4.76	866	4.95	893	5.15
4000	7	827	4.47	852	4.60	878	4.74	904	4.91	932	5.09
8000	-1	861	4.48	886	4.60	911	4.73	936	4.87	961	5.03
12000	-9	890	4.48	914	4.59	937	4.70	961	4.82	984	4.96
16000	-17	913	4.47	935	4.56	957	4.65	978	4.76	997	4.87
18000	-21	921	4.46	942	4.54	963	4.62	982	4.71	1000	4.81
20000	-25	928	4.44	949	4.51	968	4.59	986	4.67	1001	4.75
22000	-29	935	4.42	955	4.48	973	4.55	988	4.62	1001	4.69
24000	-33	940	4.40	959	4.46	975	4.51	989	4.57	999	4.62
25000	-35	943	4.39	960	4.44	976	4.49	989	4.54	998	4.59

Some (low) power settings may not be attainable due to low cylinder or oil temperatures depending on ambient conditions



RANGE AND ENDURANCE - (100 GAL - Cruise MAP = 26 inHG / Cruise RPM = 2500)

Mixture = Best Power											
Cruise MAP = 26 inHG Cruise RPM = 2500											
Press Alt Ft	STD OAT °C	ISA -30°C		ISA -15°C		ISA +0°C		ISA +15°C		ISA +30°C	
		NMI	HRS	NMI	HRS	NMI	HRS	NMI	HRS	NMI	HRS
0	15	715	4.15	743	4.31	772	4.48	802	4.68	834	4.90
4000	7	755	4.17	783	4.31	811	4.47	841	4.65	872	4.85
8000	-1	789	4.19	817	4.32	845	4.47	874	4.63	904	4.80
12000	-9	820	4.21	847	4.33	875	4.46	902	4.60	930	4.75
16000	-17	845	4.22	871	4.32	897	4.43	922	4.55	946	4.67
18000	-21	857	4.21	881	4.31	906	4.41	929	4.52	952	4.63
20000	-25	866	4.21	890	4.30	913	4.39	935	4.48	956	4.58
22000	-29	875	4.20	899	4.28	920	4.36	940	4.45	958	4.53
24000	-33	883	4.20	906	4.27	926	4.34	944	4.41	959	4.48
25000	-35	887	4.19	909	4.26	928	4.32	945	4.39	959	4.45

Mixture = Best Economy											
Cruise MAP = 26 inHG Cruise RPM = 2500											
Press Alt Ft	STD OAT °C	ISA -30°C		ISA -15°C		ISA +0°C		ISA +15°C		ISA +30°C	
		NMI	HRS	NMI	HRS	NMI	HRS	NMI	HRS	NMI	HRS
0	15	828	4.95	855	5.11	883	5.30	911	5.50	940	5.73
4000	7	874	4.95	900	5.10	927	5.26	954	5.45	981	5.65
8000	-1	914	4.96	940	5.09	966	5.24	992	5.40	1018	5.58
12000	-9	946	4.95	971	5.07	996	5.19	1020	5.33	1043	5.48
16000	-17	971	4.92	995	5.02	1017	5.13	1039	5.24	1059	5.37
18000	-21	982	4.90	1004	4.99	1025	5.09	1045	5.19	1062	5.30
20000	-25	990	4.88	1012	4.96	1032	5.04	1050	5.13	1065	5.23
22000	-29	997	4.85	1017	4.92	1035	5.00	1051	5.07	1064	5.15
24000	-33	1003	4.82	1022	4.88	1038	4.95	1051	5.01	1061	5.07
25000	-35	1005	4.81	1024	4.86	1039	4.92	1050	4.97	1058	5.02

Some (low) power settings may not be attainable due to low cylinder or oil temperatures depending on ambient conditions



RANGE AND ENDURANCE - (100 GAL - Cruise MAP = 22 inHG / Cruise RPM = 2500)

Cruise MAP = 22 inHG Cruise RPM = 2500											
Mixture = Best Power						Cruise MAP = 22 inHG Cruise RPM = 2500					
Press Alt Ft	STD OAT °C	ISA -30°C		ISA -15°C		ISA +0°C		ISA +15°C		ISA +30°C	
		NMI	HRS	NMI	HRS	NMI	HRS	NMI	HRS	NMI	HRS
0	15	790	4.96	821	5.15	851	5.35	883	5.58	915	5.84
4000	7	835	4.97	865	5.14	896	5.32	927	5.53	960	5.76
8000	-1	877	4.96	907	5.11	936	5.28	967	5.47	998	5.67
12000	-9	911	4.94	939	5.07	968	5.22	996	5.38	1025	5.56
16000	-17	935	4.90	963	5.02	989	5.14	1015	5.28	1040	5.42
18000	-21	944	4.87	972	4.98	997	5.09	1021	5.21	1044	5.34
20000	-25	952	4.84	978	4.94	1001	5.04	1023	5.15	1043	5.26
22000	-29	959	4.80	984	4.89	1006	4.98	1026	5.07	1044	5.17
24000	-33	964	4.77	987	4.84	1007	4.92	1025	5.00	1039	5.07
25000	-35	966	4.75	988	4.82	1007	4.89	1023	4.96	1036	5.02

Cruise MAP = 22 inHG Cruise RPM = 2500											
Mixture = Best Economy						Cruise MAP = 22 inHG Cruise RPM = 2500					
Press Alt Ft	STD OAT °C	ISA -30°C		ISA -15°C		ISA +0°C		ISA +15°C		ISA +30°C	
		NMI	HRS	NMI	HRS	NMI	HRS	NMI	HRS	NMI	HRS
0	15	902	5.91	930	6.11	958	6.33	986	6.57	1014	6.85
4000	7	956	5.89	985	6.07	1014	6.26	1042	6.48	1070	6.73
8000	-1	1002	5.86	1029	6.01	1056	6.19	1084	6.38	1110	6.60
12000	-9	1040	5.80	1067	5.94	1093	6.09	1117	6.26	1141	6.44
16000	-17	1067	5.72	1091	5.84	1114	5.96	1136	6.10	1156	6.24
18000	-21	1076	5.67	1099	5.78	1121	5.89	1140	6.01	1157	6.14
20000	-25	1081	5.62	1106	5.71	1126	5.81	1143	5.91	1157	6.02
22000	-29	1087	5.55	1108	5.64	1125	5.72	1140	5.81	1152	5.90
24000	-33	1090	5.49	1109	5.56	1124	5.63	1136	5.70	1144	5.77
25000	-35	1090	5.46	1109	5.52	1123	5.58	1134	5.65	1140	5.70

Some (low) power settings may not be attainable due to low cylinder or oil temperatures depending on ambient conditions



RANGE AND ENDURANCE - (100 GAL - Cruise MAP = 30.5 inHG / Cruise RPM = 2400)

Mixture = Best Power											
Cruise MAP = 30.5 inHG Cruise RPM = 2400											
Press Alt Ft	STD OAT °C	ISA -30°C		ISA -15°C		ISA +0°C		ISA +15°C		ISA +30°C	
		NMI	HRS	NMI	HRS	NMI	HRS	NMI	HRS	NMI	HRS
0	15	684	3.75	711	3.89	739	4.05	769	4.23	801	4.43
4000	7	714	3.76	741	3.89	769	4.04	798	4.20	829	4.38
8000	-1	740	3.78	767	3.90	794	4.03	822	4.17	851	4.33
12000	-9	764	3.79	789	3.89	816	4.01	842	4.14	869	4.28
16000	-17	785	3.79	809	3.88	834	3.98	858	4.09	882	4.21
18000	-21	793	3.79	818	3.87	841	3.97	865	4.06	887	4.17
20000	-25	801	3.79	824	3.87	846	3.95	868	4.04	888	4.13
22000	-29	808	3.79	830	3.86	851	3.93	871	4.01	890	4.09
24000	-33	816	3.79	836	3.85	856	3.92	875	3.98	891	4.05
25000	-35	820	3.79	839	3.85	859	3.91	876	3.97	890	4.03

Mixture = Best Economy											
Cruise MAP = 30.5 inHG Cruise RPM = 2400											
Press Alt Ft	STD OAT °C	ISA -30°C		ISA -15°C		ISA +0°C		ISA +15°C		ISA +30°C	
		NMI	HRS	NMI	HRS	NMI	HRS	NMI	HRS	NMI	HRS
0	15	801	4.49	826	4.63	853	4.80	880	4.98	909	5.18
4000	7	835	4.49	861	4.62	887	4.76	913	4.93	941	5.11
8000	-1	866	4.48	890	4.60	915	4.73	940	4.87	966	5.03
12000	-9	890	4.46	913	4.56	937	4.68	960	4.80	984	4.93
16000	-17	908	4.43	930	4.51	952	4.61	972	4.71	992	4.82
18000	-21	915	4.41	936	4.48	956	4.57	976	4.66	994	4.76
20000	-25	920	4.38	941	4.45	961	4.53	978	4.61	994	4.69
22000	-29	924	4.36	944	4.42	962	4.49	977	4.55	991	4.62
24000	-33	929	4.34	946	4.39	962	4.44	976	4.50	986	4.55
25000	-35	931	4.32	947	4.37	962	4.42	975	4.47	984	4.52

Some (low) power settings may not be attainable due to low cylinder or oil temperatures depending on ambient conditions



RANGE AND ENDURANCE - (100 GAL - Cruise MAP = 27 inHG / Cruise RPM = 2400)

Cruise MAP = 27 inHG Cruise RPM = 2400											
Mixture = Best Power						Cruise MAP = 27 inHG Cruise RPM = 2400					
Press Alt Ft	STD OAT °C	ISA -30°C NMI	ISA -30°C HRS	ISA -15°C NMI	ISA -15°C HRS	ISA +0°C NMI	ISA +0°C HRS	ISA +15°C NMI	ISA +15°C HRS	ISA +30°C NMI	ISA +30°C HRS
0	15	746	4.34	774	4.51	804	4.69	835	4.89	868	5.12
4000	7	774	4.28	802	4.43	831	4.59	862	4.77	894	4.98
8000	-1	800	4.25	828	4.38	857	4.53	886	4.69	916	4.87
12000	-9	824	4.23	852	4.35	879	4.48	906	4.62	934	4.77
16000	-17	848	4.23	874	4.33	899	4.44	924	4.56	949	4.69
18000	-21	859	4.23	885	4.32	909	4.43	933	4.53	955	4.65
20000	-25	870	4.23	894	4.31	917	4.40	939	4.50	959	4.60
22000	-29	878	4.22	902	4.30	924	4.38	944	4.46	962	4.55
24000	-33	884	4.21	908	4.28	927	4.35	945	4.42	960	4.49
25000	-35	889	4.20	909	4.27	928	4.33	945	4.39	959	4.46

Cruise MAP = 27 inHG Cruise RPM = 2400											
Mixture = Best Economy						Cruise MAP = 27 inHG Cruise RPM = 2400					
Press Alt Ft	STD OAT °C	ISA -30°C NMI	ISA -30°C HRS	ISA -15°C NMI	ISA -15°C HRS	ISA +0°C NMI	ISA +0°C HRS	ISA +15°C NMI	ISA +15°C HRS	ISA +30°C NMI	ISA +30°C HRS
0	15	859	5.15	886	5.32	914	5.51	942	5.73	973	5.96
4000	7	894	5.07	921	5.22	948	5.38	976	5.57	1005	5.78
8000	-1	924	5.01	950	5.14	976	5.29	1002	5.45	1029	5.63
12000	-9	951	4.96	975	5.08	1000	5.20	1024	5.34	1048	5.50
16000	-17	974	4.93	997	5.02	1020	5.13	1041	5.24	1062	5.37
18000	-21	983	4.91	1005	4.99	1026	5.09	1046	5.19	1065	5.30
20000	-25	992	4.88	1013	4.96	1033	5.05	1050	5.14	1066	5.23
22000	-29	999	4.86	1019	4.93	1037	5.00	1052	5.07	1065	5.15
24000	-33	1003	4.82	1022	4.88	1039	4.94	1052	5.00	1062	5.06
25000	-35	1004	4.80	1023	4.86	1039	4.91	1051	4.96	1059	5.02

Some (low) power settings may not be attainable due to low cylinder or oil temperatures depending on ambient conditions



RANGE AND ENDURANCE - (100 GAL - Cruise MAP = 24 inHG / Cruise RPM = 2400)

Cruise MAP = 24 inHG Cruise RPM = 2400											
Mixture = Best Power						Cruise MAP = 24 inHG Cruise RPM = 2400					
Press Alt Ft	STD OAT °C	ISA -30°C		ISA -15°C		ISA +0°C		ISA +15°C		ISA +30°C	
		NMI	HRS	NMI	HRS	NMI	HRS	NMI	HRS	NMI	HRS
0	15	812	5.05	842	5.24	874	5.45	906	5.68	940	5.94
4000	7	838	4.88	868	5.05	898	5.23	930	5.44	963	5.66
8000	-1	862	4.78	891	4.92	921	5.09	951	5.26	982	5.46
12000	-9	887	4.72	916	4.85	944	4.99	972	5.15	1001	5.31
16000	-17	911	4.69	938	4.81	964	4.93	990	5.06	1015	5.20
18000	-21	923	4.69	949	4.79	974	4.90	998	5.02	1021	5.14
20000	-25	932	4.67	957	4.77	981	4.87	1003	4.97	1024	5.08
22000	-29	941	4.65	965	4.74	987	4.83	1007	4.92	1024	5.01
24000	-33	947	4.62	969	4.70	989	4.77	1007	4.85	1022	4.92
25000	-35	948	4.60	970	4.67	989	4.74	1006	4.80	1019	4.87

Cruise MAP = 24 inHG Cruise RPM = 2400											
Mixture = Best Economy						Cruise MAP = 24 inHG Cruise RPM = 2400					
Press Alt Ft	STD OAT °C	ISA -30°C		ISA -15°C		ISA +0°C		ISA +15°C		ISA +30°C	
		NMI	HRS	NMI	HRS	NMI	HRS	NMI	HRS	NMI	HRS
0	15	930	5.99	958	6.19	988	6.41	1017	6.66	1047	6.94
4000	7	958	5.77	986	5.94	1014	6.13	1043	6.34	1072	6.58
8000	-1	988	5.61	1016	5.76	1043	5.93	1070	6.12	1097	6.32
12000	-9	1014	5.52	1041	5.65	1066	5.79	1091	5.95	1115	6.12
16000	-17	1039	5.46	1063	5.57	1086	5.69	1108	5.82	1129	5.96
18000	-21	1049	5.43	1073	5.53	1095	5.64	1114	5.75	1132	5.87
20000	-25	1059	5.40	1081	5.49	1101	5.58	1119	5.68	1135	5.79
22000	-29	1065	5.36	1085	5.44	1103	5.52	1119	5.60	1131	5.69
24000	-33	1067	5.30	1087	5.37	1103	5.44	1115	5.50	1124	5.57
25000	-35	1068	5.26	1086	5.32	1101	5.38	1112	5.44	1118	5.50

Some (low) power settings may not be attainable due to low cylinder or oil temperatures depending on ambient conditions



RANGE AND ENDURANCE - (100 GAL - Cruise MAP = 21 inHG / Cruise RPM = 2400)

Cruise MAP = 21 inHG Cruise RPM = 2400											
Mixture = Best Power						Cruise MAP = 21 inHG Cruise RPM = 2400					
Press Alt Ft	STD OAT °C	ISA -30°C NMI	ISA -30°C HRS	ISA -15°C NMI	ISA -15°C HRS	ISA +0°C NMI	ISA +0°C HRS	ISA +15°C NMI	ISA +15°C HRS	ISA +30°C NMI	ISA +30°C HRS
0	15	897	6.07	929	6.30	961	6.54	994	6.81	1028	7.12
4000	7	916	5.71	948	5.90	980	6.11	1013	6.35	1047	6.61
8000	-1	938	5.48	968	5.64	999	5.83	1031	6.03	1062	6.25
12000	-9	960	5.34	990	5.49	1019	5.65	1048	5.82	1077	6.01
16000	-17	984	5.28	1012	5.40	1039	5.54	1065	5.68	1090	5.83
18000	-21	994	5.25	1021	5.36	1046	5.49	1070	5.62	1093	5.75
20000	-25	1003	5.22	1029	5.32	1053	5.43	1075	5.54	1094	5.66
22000	-29	1010	5.17	1034	5.26	1056	5.36	1075	5.46	1092	5.56
24000	-33	1010	5.10	1032	5.18	1052	5.26	1069	5.34	1083	5.42
25000	-35	1008	5.05	1029	5.13	1048	5.20	1064	5.27	1076	5.34

Cruise MAP = 21 inHG Cruise RPM = 2400											
Mixture = Best Economy						Cruise MAP = 21 inHG Cruise RPM = 2400					
Press Alt Ft	STD OAT °C	ISA -30°C NMI	ISA -30°C HRS	ISA -15°C NMI	ISA -15°C HRS	ISA +0°C NMI	ISA +0°C HRS	ISA +15°C NMI	ISA +15°C HRS	ISA +30°C NMI	ISA +30°C HRS
0	15	1017	7.24	1047	7.49	1076	7.75	1103	8.05	1128	8.39
4000	7	1044	6.76	1074	6.97	1103	7.19	1132	7.45	1160	7.73
8000	-1	1066	6.45	1094	6.62	1122	6.82	1150	7.03	1177	7.26
12000	-9	1093	6.26	1120	6.41	1147	6.57	1172	6.75	1195	6.95
16000	-17	1117	6.15	1142	6.27	1165	6.41	1186	6.55	1205	6.71
18000	-21	1127	6.10	1151	6.21	1173	6.33	1192	6.46	1208	6.60
20000	-25	1135	6.04	1157	6.14	1177	6.25	1194	6.36	1207	6.48
22000	-29	1137	5.97	1157	6.06	1175	6.15	1190	6.25	1200	6.34
24000	-33	1137	5.87	1156	5.94	1171	6.02	1183	6.09	1189	6.17
25000	-35	1133	5.80	1151	5.87	1165	5.94	1175	6.00	1179	6.06

Some (low) power settings may not be attainable due to low cylinder or oil temperatures depending on ambient conditions



RANGE AND ENDURANCE - (100 GAL - Cruise MAP = 28 inHG / Cruise RPM = 2300)

Cruise MAP = 28 inHG Cruise RPM = 2300													
Mixture = Best Power		ISA -30°C		ISA -15°C		ISA +0°C		ISA +15°C		ISA +30°C			
Press Alt Ft	STD OAT °C	NMI	HRS	NMI	HRS	NMI	HRS	NMI	HRS	NMI	HRS	NMI	HRS
0	15	757	4.39	786	4.55	817	4.74	848	4.94	882	5.17		
4000	7	787	4.36	816	4.51	846	4.68	876	4.86	909	5.07		
8000	-1	814	4.34	842	4.48	871	4.63	901	4.79	931	4.97		
12000	-9	839	4.33	866	4.45	893	4.58	921	4.72	949	4.88		
16000	-17	860	4.30	886	4.41	912	4.52	937	4.64	961	4.77		
18000	-21	869	4.29	895	4.39	919	4.49	943	4.60	966	4.71		
20000	-25	878	4.28	902	4.37	925	4.46	946	4.55	967	4.66		
22000	-29	885	4.27	908	4.35	930	4.43	950	4.51	968	4.60		
24000	-33	893	4.27	916	4.34	936	4.41	955	4.48	970	4.55		
25000	-35	897	4.27	919	4.33	939	4.40	956	4.46	970	4.52		

Cruise MAP = 28 inHG Cruise RPM = 2300													
Mixture = Best Economy		ISA -30°C		ISA -15°C		ISA +0°C		ISA +15°C		ISA +30°C			
Press Alt Ft	STD OAT °C	NMI	HRS	NMI	HRS	NMI	HRS	NMI	HRS	NMI	HRS	NMI	HRS
0	15	872	5.18	899	5.35	928	5.54	957	5.75	988	5.99		
4000	7	907	5.14	934	5.29	962	5.46	990	5.65	1020	5.86		
8000	-1	939	5.10	965	5.23	991	5.38	1018	5.55	1046	5.73		
12000	-9	964	5.05	989	5.16	1014	5.29	1039	5.43	1063	5.59		
16000	-17	983	4.99	1007	5.09	1029	5.19	1051	5.31	1071	5.43		
18000	-21	991	4.95	1014	5.04	1035	5.14	1055	5.24	1073	5.35		
20000	-25	998	4.92	1020	5.00	1040	5.09	1058	5.18	1073	5.27		
22000	-29	1004	4.89	1024	4.96	1042	5.04	1058	5.11	1071	5.19		
24000	-33	1009	4.87	1027	4.93	1043	4.99	1057	5.05	1066	5.11		
25000	-35	1011	4.85	1029	4.91	1045	4.97	1057	5.02	1064	5.07		

Some (low) power settings may not be attainable due to low cylinder or oil temperatures depending on ambient conditions



RANGE AND ENDURANCE - (100 GAL - Cruise MAP = 25 inHG / Cruise RPM = 2300)

Cruise MAP = 25 inHG Cruise RPM = 2300													
Mixture = Best Power		ISA -30°C		ISA -15°C		ISA +0°C		ISA +15°C		ISA +30°C			
Press Alt Ft	STD OAT °C	NMI	HRS	NMI	HRS	NMI	HRS	NMI	HRS	NMI	HRS	NMI	HRS
0	15	820	5.04	851	5.23	882	5.43	915	5.67	949	5.92		
4000	7	851	4.94	881	5.11	912	5.30	944	5.50	978	5.73		
8000	-1	879	4.88	908	5.04	939	5.20	969	5.38	1001	5.58		
12000	-9	904	4.84	933	4.98	961	5.12	990	5.28	1018	5.45		
16000	-17	927	4.80	954	4.91	980	5.04	1006	5.17	1031	5.31		
18000	-21	937	4.78	963	4.88	988	4.99	1012	5.11	1035	5.24		
20000	-25	946	4.75	970	4.85	994	4.95	1016	5.05	1037	5.17		
22000	-29	953	4.73	977	4.81	1000	4.90	1020	4.99	1038	5.09		
24000	-33	960	4.70	982	4.78	1002	4.85	1019	4.93	1034	5.01		
25000	-35	962	4.69	983	4.76	1002	4.83	1018	4.90	1031	4.96		

Cruise MAP = 25 inHG Cruise RPM = 2300													
Mixture = Best Economy		ISA -30°C		ISA -15°C		ISA +0°C		ISA +15°C		ISA +30°C			
Press Alt Ft	STD OAT °C	NMI	HRS	NMI	HRS	NMI	HRS	NMI	HRS	NMI	HRS	NMI	HRS
0	15	934	5.94	964	6.14	993	6.35	1024	6.60	1056	6.87		
4000	7	971	5.80	1000	5.98	1029	6.17	1058	6.38	1088	6.62		
8000	-1	1004	5.71	1031	5.87	1059	6.04	1087	6.22	1114	6.43		
12000	-9	1032	5.64	1058	5.77	1084	5.91	1109	6.07	1134	6.25		
16000	-17	1054	5.56	1078	5.67	1102	5.79	1124	5.92	1144	6.06		
18000	-21	1062	5.51	1085	5.61	1107	5.72	1127	5.84	1145	5.96		
20000	-25	1068	5.47	1091	5.56	1111	5.65	1129	5.75	1144	5.86		
22000	-29	1075	5.42	1095	5.50	1114	5.58	1129	5.67	1141	5.75		
24000	-33	1079	5.37	1098	5.44	1115	5.51	1127	5.58	1136	5.64		
25000	-35	1081	5.35	1100	5.41	1115	5.47	1126	5.53	1132	5.58		

Some (low) power settings may not be attainable due to low cylinder or oil temperatures depending on ambient conditions



RANGE AND ENDURANCE - (100 GAL - Cruise MAP = 22 inHG / Cruise RPM = 2300)

Cruise MAP = 22 inHG Cruise RPM = 2300											
Mixture = Best Power		ISA -30°C		ISA -15°C		ISA +0°C		ISA +15°C		ISA +30°C	
Press Alt Ft	STD OAT °C	NMI	HRS	NMI	HRS	NMI	HRS	NMI	HRS	NMI	HRS
0	15	901	5.96	933	6.17	966	6.41	1000	6.68	1036	6.98
4000	7	928	5.73	960	5.92	993	6.14	1026	6.37	1059	6.63
8000	-1	958	5.60	989	5.77	1020	5.96	1052	6.16	1085	6.39
12000	-9	984	5.51	1014	5.66	1044	5.82	1073	6.00	1102	6.20
16000	-17	1005	5.43	1033	5.56	1060	5.69	1087	5.84	1111	6.00
18000	-21	1015	5.38	1042	5.50	1068	5.63	1092	5.76	1115	5.90
20000	-25	1021	5.33	1046	5.44	1070	5.55	1092	5.67	1112	5.79
22000	-29	1025	5.28	1049	5.37	1071	5.47	1091	5.57	1108	5.67
24000	-33	1028	5.21	1051	5.30	1071	5.38	1088	5.46	1101	5.54
25000	-35	1028	5.18	1050	5.25	1069	5.33	1084	5.40	1096	5.47

Cruise MAP = 22 inHG Cruise RPM = 2300											
Mixture = Best Economy		ISA -30°C		ISA -15°C		ISA +0°C		ISA +15°C		ISA +30°C	
Press Alt Ft	STD OAT °C	NMI	HRS	NMI	HRS	NMI	HRS	NMI	HRS	NMI	HRS
0	15	1022	7.04	1052	7.28	1082	7.53	1112	7.82	1140	8.15
4000	7	1052	6.74	1082	6.94	1112	7.17	1143	7.42	1173	7.70
8000	-1	1087	6.56	1116	6.73	1145	6.93	1173	7.15	1200	7.39
12000	-9	1116	6.42	1143	6.58	1170	6.74	1195	6.93	1220	7.13
16000	-17	1139	6.29	1164	6.42	1187	6.56	1209	6.71	1228	6.87
18000	-21	1144	6.22	1168	6.34	1190	6.47	1210	6.60	1227	6.74
20000	-25	1150	6.15	1173	6.25	1193	6.36	1210	6.48	1223	6.59
22000	-29	1153	6.07	1173	6.15	1191	6.25	1206	6.34	1216	6.44
24000	-33	1152	5.97	1171	6.05	1186	6.13	1197	6.20	1203	6.27
25000	-35	1150	5.92	1168	5.99	1182	6.06	1192	6.12	1195	6.19

Some (low) power settings may not be attainable due to low cylinder or oil temperatures depending on ambient conditions



RANGE AND ENDURANCE - (100 GAL - Cruise MAP = 19 inHG / Cruise RPM = 2300)

Cruise MAP = 19 inHG Cruise RPM = 2300											
Mixture = Best Power						Mixture = Best Economy					
Press Alt Ft	STD OAT °C	ISA -30°C		ISA -15°C		ISA +0°C		ISA +15°C		ISA +30°C	
		NMI	HRS	NMI	HRS	NMI	HRS	NMI	HRS	NMI	HRS
0	15	1000	7.31	1034	7.58	1067	7.86	1101	8.19	1135	8.55
4000	7	1027	6.86	1061	7.08	1095	7.33	1129	7.61	1163	7.91
8000	-1	1054	6.59	1087	6.79	1119	7.01	1152	7.25	1184	7.51
12000	-9	1082	6.42	1113	6.59	1144	6.77	1173	6.98	1202	7.20
16000	-17	1100	6.26	1129	6.41	1156	6.56	1182	6.73	1206	6.91
18000	-21	1106	6.17	1134	6.31	1159	6.45	1183	6.60	1204	6.76
20000	-25	1108	6.08	1133	6.20	1157	6.32	1178	6.45	1196	6.59
22000	-29	1107	5.97	1131	6.07	1153	6.18	1172	6.29	1187	6.40
24000	-33	1102	5.84	1124	5.93	1143	6.02	1159	6.11	1170	6.19
25000	-35	1097	5.76	1119	5.85	1136	5.93	1150	6.01	1159	6.08

Cruise MAP = 19 inHG Cruise RPM = 2300											
Mixture = Best Power						Mixture = Best Economy					
Press Alt Ft	STD OAT °C	ISA -30°C		ISA -15°C		ISA +0°C		ISA +15°C		ISA +30°C	
		NMI	HRS	NMI	HRS	NMI	HRS	NMI	HRS	NMI	HRS
0	15	1124	8.76	1152	9.05	1179	9.37	1204	9.73	1225	10.14
4000	7	1160	8.13	1191	8.38	1220	8.65	1247	8.95	1272	9.29
8000	-1	1192	7.77	1222	7.98	1251	8.21	1279	8.47	1304	8.76
12000	-9	1221	7.52	1250	7.70	1276	7.90	1300	8.12	1322	8.35
16000	-17	1241	7.30	1267	7.45	1290	7.62	1310	7.79	1326	7.98
18000	-21	1245	7.18	1269	7.32	1289	7.46	1307	7.62	1321	7.78
20000	-25	1246	7.05	1268	7.17	1286	7.30	1300	7.43	1309	7.57
22000	-29	1242	6.90	1262	7.01	1278	7.11	1289	7.22	1294	7.33
24000	-33	1232	6.73	1250	6.82	1264	6.90	1272	6.99	1273	7.07
25000	-35	1227	6.63	1244	6.71	1256	6.79	1262	6.86	1260	6.93

Some (low) power settings may not be attainable due to low cylinder or oil temperatures depending on ambient conditions



RANGE AND ENDURANCE - (100 GAL - Cruise MAP = 21 inHG / Cruise RPM = 2200)

Cruise MAP = 21 inHG Cruise RPM = 2200											
Mixture = Best Power		ISA -30°C		ISA -15°C		ISA +0°C		ISA +15°C		ISA +30°C	
Press Alt Ft	STD OAT °C	NMI	HRS	NMI	HRS	NMI	HRS	NMI	HRS	NMI	HRS
0	15	967	6.64	1000	6.88	1035	7.15	1071	7.44	1107	7.77
4000	7	1003	6.45	1037	6.66	1070	6.90	1105	7.16	1139	7.45
8000	-1	1043	6.38	1076	6.57	1108	6.78	1141	7.01	1174	7.27
12000	-9	1074	6.29	1105	6.46	1136	6.64	1166	6.84	1195	7.06
16000	-17	1091	6.15	1120	6.29	1148	6.45	1175	6.61	1199	6.79
18000	-21	1097	6.05	1125	6.18	1151	6.32	1175	6.47	1197	6.63
20000	-25	1098	5.95	1124	6.07	1148	6.19	1169	6.32	1188	6.45
22000	-29	1097	5.85	1122	5.95	1143	6.06	1162	6.17	1178	6.28
24000	-33	1098	5.75	1120	5.84	1139	5.93	1155	6.02	1166	6.11
25000	-35	1097	5.71	1119	5.79	1137	5.87	1151	5.95	1160	6.03

Cruise MAP = 21 inHG Cruise RPM = 2200											
Mixture = Best Economy		ISA -30°C		ISA -15°C		ISA +0°C		ISA +15°C		ISA +30°C	
Press Alt Ft	STD OAT °C	NMI	HRS	NMI	HRS	NMI	HRS	NMI	HRS	NMI	HRS
0	15	1091	7.82	1122	8.08	1153	8.36	1184	8.68	1212	9.05
4000	7	1129	7.55	1161	7.78	1192	8.03	1223	8.31	1253	8.63
8000	-1	1176	7.43	1206	7.64	1235	7.86	1263	8.11	1290	8.38
12000	-9	1210	7.31	1238	7.48	1265	7.67	1291	7.88	1314	8.11
16000	-17	1228	7.11	1254	7.25	1277	7.41	1298	7.58	1316	7.76
18000	-21	1229	6.98	1253	7.11	1275	7.25	1293	7.40	1309	7.56
20000	-25	1230	6.84	1253	6.96	1272	7.08	1288	7.21	1299	7.34
22000	-29	1227	6.70	1247	6.80	1264	6.91	1277	7.01	1284	7.12
24000	-33	1223	6.58	1241	6.66	1255	6.75	1264	6.83	1267	6.91
25000	-35	1221	6.52	1238	6.60	1250	6.67	1257	6.74	1257	6.81

Some (low) power settings may not be attainable due to low cylinder or oil temperatures depending on ambient conditions



RANGE AND ENDURANCE - (100 GAL - Cruise MAP = 21 inHG / Cruise RPM = 2100)

Cruise MAP = 21 inHG Cruise RPM = 2100											
Mixture = Best Power		ISA -30°C		ISA -15°C		ISA +0°C		ISA +15°C		ISA +30°C	
Press Alt Ft	STD OAT °C	NMI	HRS	NMI	HRS	NMI	HRS	NMI	HRS	NMI	HRS
0	15	1002	6.96	1036	7.21	1071	7.49	1108	7.80	1145	8.14
4000	7	1051	6.89	1085	7.12	1120	7.37	1155	7.64	1190	7.95
8000	-1	1103	6.94	1137	7.15	1170	7.37	1203	7.62	1237	7.90
12000	-9	1143	6.90	1174	7.08	1205	7.28	1235	7.50	1265	7.74
16000	-17	1157	6.70	1187	6.86	1215	7.02	1241	7.20	1265	7.39
18000	-21	1156	6.56	1184	6.70	1210	6.85	1234	7.01	1254	7.17
20000	-25	1152	6.41	1178	6.53	1202	6.66	1223	6.80	1241	6.94
22000	-29	1149	6.26	1173	6.37	1195	6.48	1213	6.60	1226	6.72
24000	-33	1148	6.15	1171	6.25	1189	6.34	1203	6.44	1212	6.53
25000	-35	1149	6.12	1169	6.20	1186	6.29	1198	6.37	1205	6.45

Cruise MAP = 21 inHG Cruise RPM = 2100											
Mixture = Best Economy		ISA -30°C		ISA -15°C		ISA +0°C		ISA +15°C		ISA +30°C	
Press Alt Ft	STD OAT °C	NMI	HRS	NMI	HRS	NMI	HRS	NMI	HRS	NMI	HRS
0	15	1124	8.12	1157	8.38	1189	8.68	1222	9.02	1253	9.39
4000	7	1177	8.00	1209	8.24	1241	8.51	1271	8.81	1302	9.14
8000	-1	1238	8.03	1269	8.25	1299	8.49	1327	8.76	1353	9.05
12000	-9	1277	7.96	1306	8.15	1333	8.36	1358	8.59	1381	8.84
16000	-17	1290	7.70	1316	7.86	1340	8.03	1360	8.22	1377	8.42
18000	-21	1289	7.52	1313	7.66	1335	7.81	1352	7.97	1365	8.14
20000	-25	1283	7.32	1305	7.45	1324	7.58	1338	7.71	1348	7.86
22000	-29	1275	7.14	1295	7.25	1311	7.36	1322	7.47	1327	7.58
24000	-33	1270	7.00	1288	7.09	1301	7.18	1308	7.27	1308	7.35
25000	-35	1270	6.95	1287	7.03	1298	7.11	1303	7.19	1299	7.25

Some (low) power settings may not be attainable due to low cylinder or oil temperatures depending on ambient conditions



TIME - FUEL - DISTANCE to DESCEND
(Maintain 500 fpm Rate of Descent)

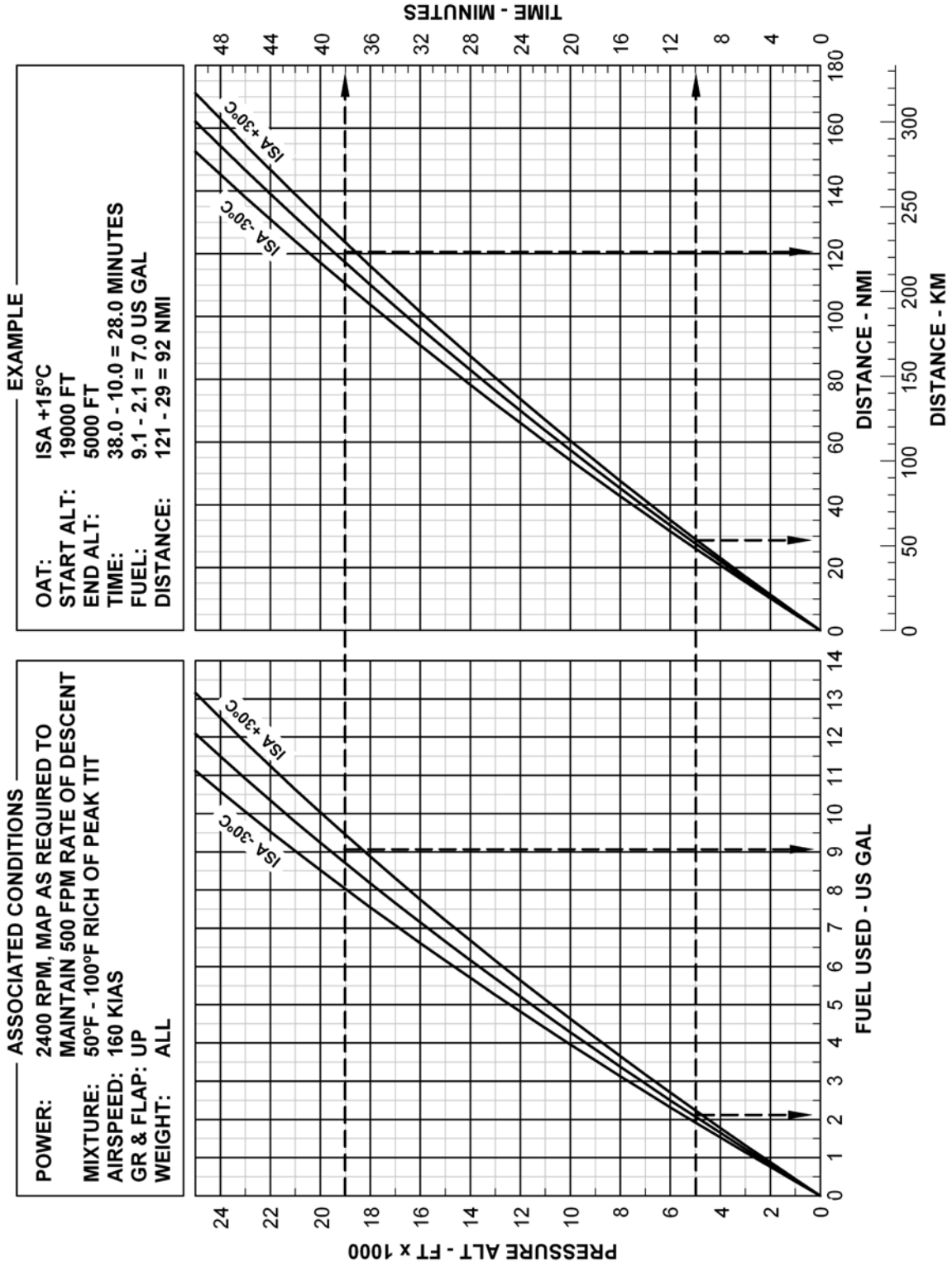

TIME - FUEL - DISTANCE to DESCEND
(Maintain 1000 fpm Rate of Descent)

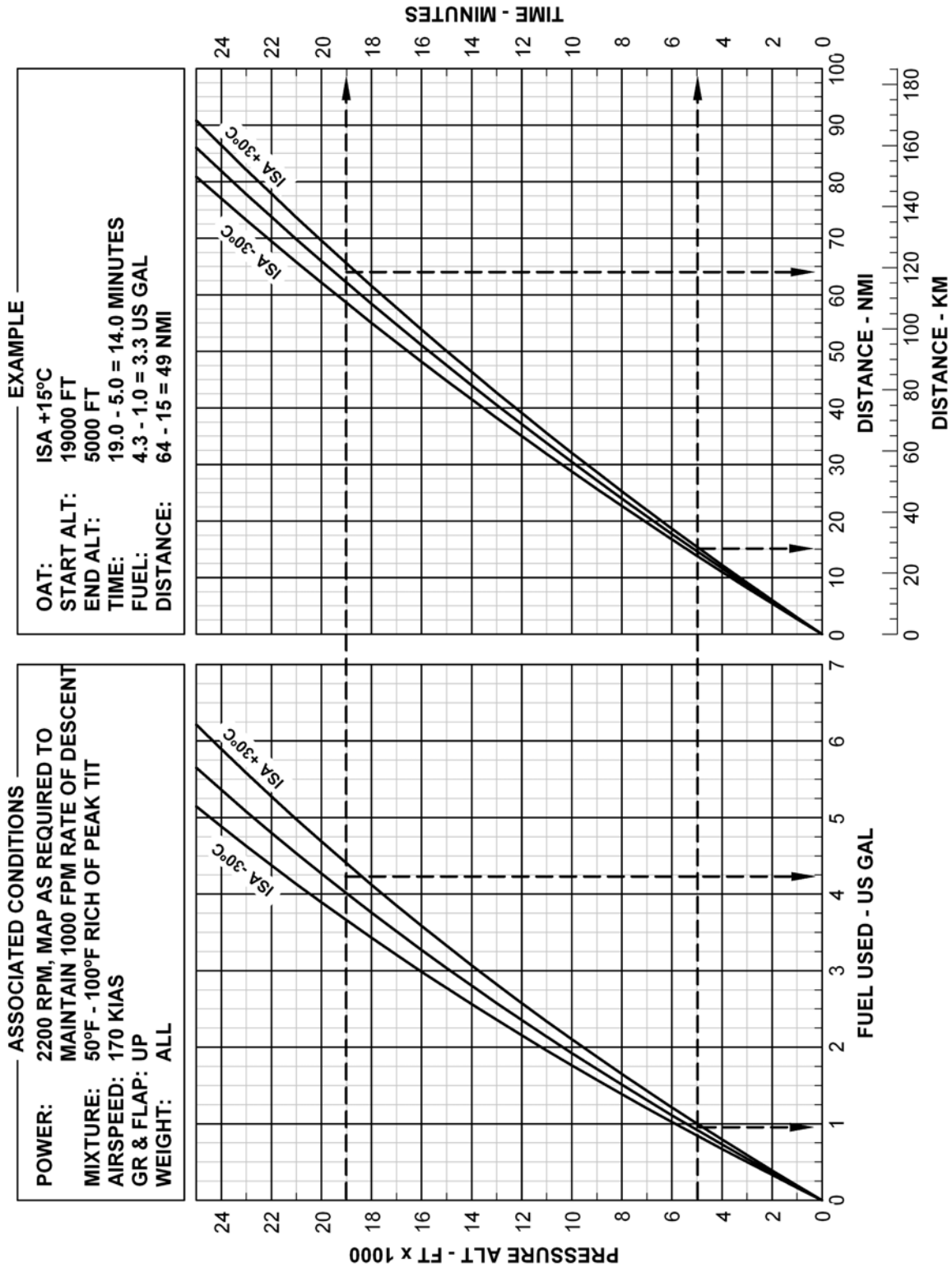

LANDING - GROUND ROLL

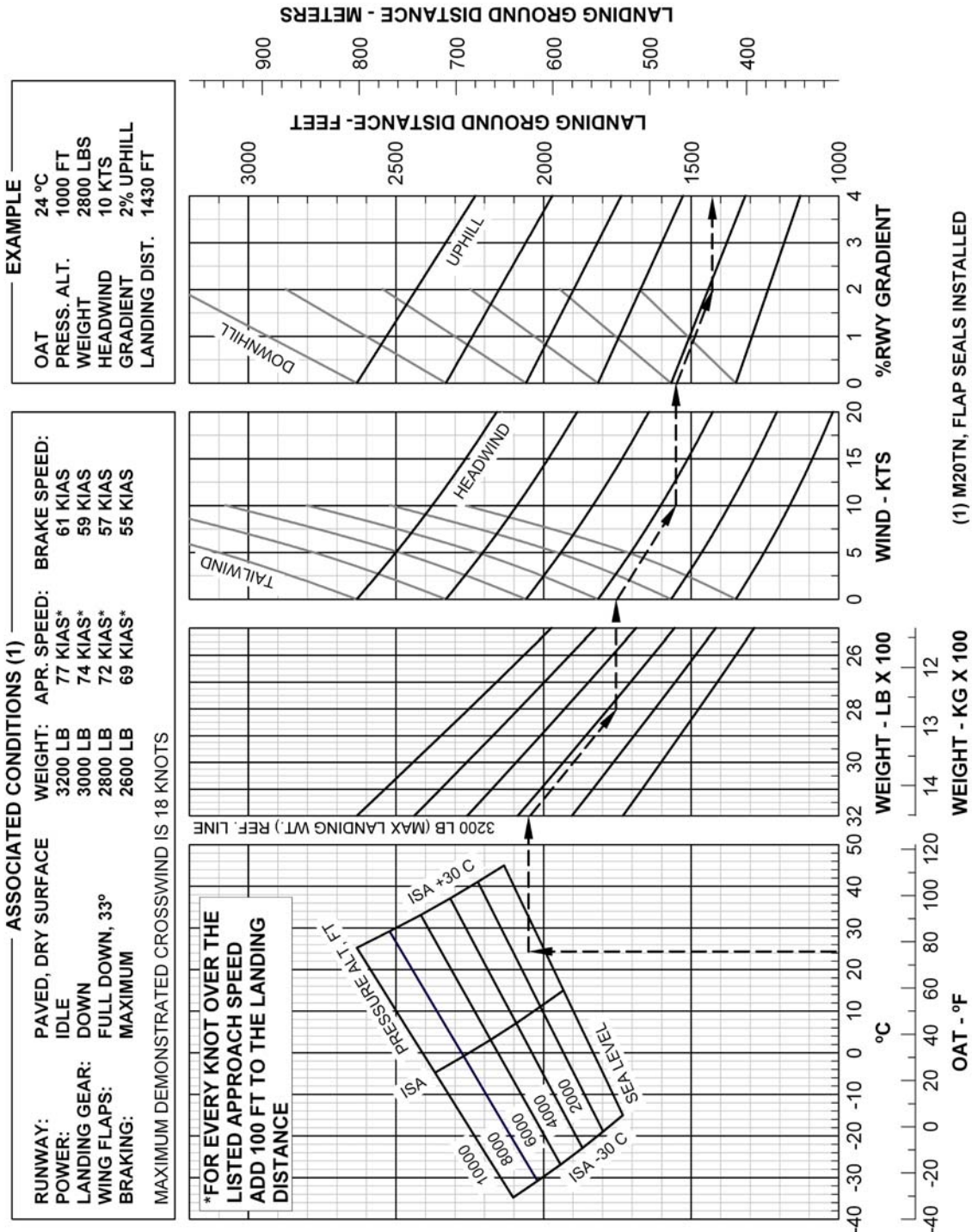

LANDING - OVER 50' (15m) OBSTACLE

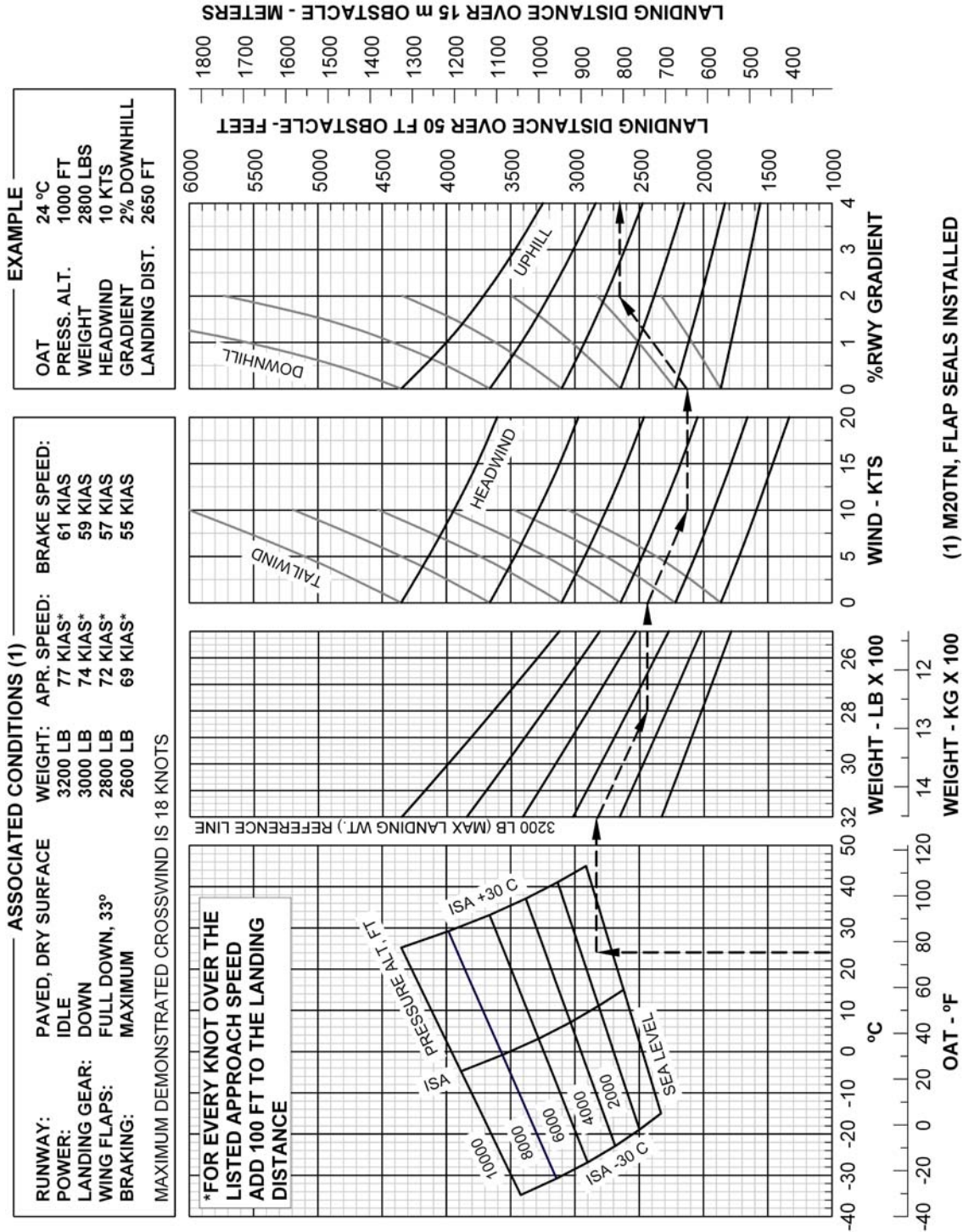

TABLE OF CONTENTS

TITLE	SECTION
INTRODUCTION	6-3
AIRPLANE WEIGHING PROCEDURE	6-4
WEIGHT & BALANCE CHART	6-5
OWNERS WEIGHT & BALANCE RECORD	6-6
PILOTS LOADING GUIDE	6-7
PROBLEM FORM	6-8
LOADING COMPUTATION GRAPH	6-9
CENTER OF GRAVITY MOMENT ENVELOPE	6-10
CENTER OF GRAVITY LIMITS ENVELOPE	6-11
FIXED BALLAST	6-12
EQUIPMENT LIST	6-12

-NOTE-

The empty weight, center of gravity and equipment list for the airplane as delivered from Mooney International Corporation is contained in this section. The use of this section is valid for use with the airplane identified below when approved by Mooney International Corporation.

MOONEY - MODEL M20V ACCLAIM ULTRA

AIRCRAFT SERIAL NO. _____

AIRCRAFT REGISTRATION NO. _____

Mooney International Corporation - Approved Signature and Date



BLANK



INTRODUCTION

This section describes the procedure for calculating loaded aircraft weight and moment for various flight operations. In addition, procedures are provided for calculating the empty weight and moment of the aircraft when the removal or addition of equipment results in changes to the empty weight and center of gravity. A comprehensive list of all Mooney equipment available for this airplane is included in this section. Only those items checked (X) were installed at Mooney and are included in the empty weight- and- balance data.

The aircraft owner and/or pilot, has the responsibility of properly loading the aircraft for safe flight. Data presented in this section will enable you to carry out this responsibility and insure that your airplane is loaded to operate within the prescribed weight and center- of- gravity limitations.

At the time of delivery, Mooney International Corporation provides the empty weight and center of gravity data for the computation of individual loadings. (The empty weight and C.G. (gear extended) as delivered from the factory is tabulated on page 6- 6 when this manual is supplied with the aircraft from the factory.)

FAA regulations also require that any change in the original equipment affecting the empty-weight and center of gravity be recorded in the Aircraft Log Book. A convenient form for maintaining a permanent record of all such changes is provided on page 6- 6. This form, if properly maintained, will enable you to determine the current weight- and- balance status of the airplane for load scheduling. The weight- and- balance data entered as your aircraft left the factory, plus the record you maintain on page 6- 6, is all of the data needed to compute loading schedules.

The maximum certificated gross weight for the CMI powered M20V is 3368 lbs (1528 Kg) for Takeoff and 3200 pounds (1452 Kgs) for Landing. Maximum useful load is determined by subtracting the corrected aircraft empty weight from its maximum gross weight. The aircraft must be operated strictly within the limits of the Center- of- Gravity Moment Envelope shown on page 6- 10.



AIRPLANE WEIGHING PROCEDURE

LEVELING

Place a spirit level on the leveling screws above the tailcone left access door when leveling the aircraft longitudinally. Level the aircraft by increasing or decreasing air pressure in the nose wheel tire.

WEIGHING

To weigh the aircraft, select a level work area and:

1. Check for installation of all equipment as listed in the Weight & Balance Record Equipment List.
2. Top off both wing tanks with full fuel. Subtract usable fuel, 100.0 U.S. gals. (378.5 liters) @ 5.82 lb/gal (100LL) (.69 Kg/l) = 582.0 lbs. (264.0 Kgs.), from total weight as weighed.

OPTIONAL METHOD - Ground aircraft and defuel tanks as follows:

- a.) Disconnect fuel line at fuel system union located forward of the firewall on the lower left hand side.
- b.) Connect a flexible line to output fitting that will reach fuel receptacle.
- c.) Turn fuel selector valve to tank to be drained; remove filler cap from fuel filler port.
- d.) Turn on fuel boost pump until tank is empty.

REPEAT STEPS C. AND D. TO DRAIN OTHER TANK.

- e.) Replace 3.0 gallons (11.4 liters) fuel into each tank (unusable fuel). (Use 5.82lb/gal. (.69 Kg/liter) for 100LL fuel).
 - f.) Replace filler caps.
3. Fill oil tank to capacity (8 qts.).
 4. Position front seats in full forward position.
 5. Position flaps in full up position.
 6. Position a 2000- pound (907.2 Kg.) capacity scale under each of the three wheels.
 7. Level aircraft as previously described making certain nose wheel is centered.
 8. Weigh the aircraft and deduct any tare from each reading.
 9. Find reference point by dropping a plumb bob from center of nose gear trunnion (retracting pivot axis) to the floor. Mark the point of intersection.
 10. Locate centerline of nose wheel axle and main wheel axles in the same manner.
 11. Measure the horizontal distance from the reference point to main wheel axle center line. Measure horizontal distance from centerline of nose wheel axle to center line of main wheel axles.
 12. Record weights and measurements, and compute basic weight and CG as follows on next page:

-NOTE-

Wing Jack Points are located at Fus. Sta. 56.658 in. (143.91 cm). Nose Jack Point is located at Fus. Sta. - 5.51 in. (- 14.0 cm.). Refer to SECTION VIII, Jacking, for procedures.



M20V - WEIGHT & BALANCE CHART

MEASUREMENTS	
L _{M/R}	INCHES/CM
L _{M/N}	INCHES/CM

SCALE POSITION AND SYMBOL	SCALE READING	TARE	NET WEIGHT
NOSE WHEEL (W _N)			
RIGHT MAIN WHEEL (W _R)			
LEFT MAIN WHEEL (W _L)			
BASIC EMPTY WEIGHT (W _T)			of fuel has been drained
AS WEIGHED (W _T)			of fuel has not been drained

a. CG Forward of Main Wheels

$$\text{Weight @ Nose (LBS/Kg)} \times \text{Distance Between Main \& Nose Wheel Axle Centers (In/cm/mm)} \div \text{Total Weight of Aircraft (LBS/Kg)} = \text{CG Forward of Main Wheels (In/cm/mm)}$$

b. CG Aft of Datum (Station 0)

$$\text{Distance from Center Nose Gear Trun- nion to Center of Main Wheel Axles (Horizontal) (L_{M/R}) - 13 In/33.0 cm/330 mm - Result of Computation Above (a.) (L_M) = CG (FUS STA) Distance Aft of Datum (Empty Weight CG) (L_{C/G})$$

WEIGHT	LBS. (Kg)	C.G. In/cm/mm	MOMENT Lb- In (Kg- cm)(Kg- mm)/1000
As Weighed (W _T)			
Usable Fuel	-	49.23 In/125 cm/1250 mm	-
Basic Empty Wt.			



PILOT'S LOADING GUIDE

LOADING CALCULATION PROCEDURE

Proper loading of the aircraft is essential for maximum flight performance and safety. This section will assist you in determining whether the aircraft loading schedule is within the approved weight and center-of-gravity limits.

To figure an actual loading problem for your aircraft, proceed as follows:

Step 1. Refer to the latest entry on page 6-6 for the current empty weight and moment.

-NOTE-

Since the engine oil is normally kept at the full level, the oil weight and moment is included in basic empty weight and is constant in calculating all loading problems.

Step 2. Note the pilot's weight and the position his seat will occupy in flight. Find this weight on the left scale of the [Loading Computation Form](#) (page 6-9) and cross the graph horizontally to the graph for #1 and #2 seats. When this point is located, drop down to the bottom scale to find the value of the moment/1000 due to the pilot's weight and seat position.

Repeat procedure for co-pilot and enter these weights and moment/1000 values in the proper sub-columns in the Problem Form on page 6-8/9.

Step 3. Proceed as in Step 2 to account for the passengers in seats 3 and 4. Enter the weight and value of moment/1000 in the proper columns.

Step 4. Again proceed as in Step 2 to account for the amount of fuel carried, and enter the weight and moment/1000 values in the proper columns.

Step 5. Once more proceed as in Step 2 to account for the baggage to be carried and enter the figures in the proper columns.

Step 6. Total the weight columns. This total must be 3368 Pounds (1528 Kg) or less. Total the Moment/1000 column.

DO NOT FORGET TO SUBTRACT NEGATIVE NUMBERS.

Step 7. Refer to the [Center-of-Gravity Moment Envelope](#) (page 6-10). Locate the loaded weight of your airplane on the left scale of the graph and trace a line horizontally to the right. Locate the total moment/1000 value for your airplane on the bottom scale of the graph and trace a line vertically above this point until the horizontal line for weight is intersected. If the point of intersection is within the shaded area, your aircraft loading is acceptable. If the point of intersection falls outside the shaded area, you must rearrange the load before take off.



PROBLEM FORM

STEP	ITEM	SAMPLE PROBLEM		YOUR PROBLEM	
		WEIGHT (Kg) Lbs	MOMENT (Kg-cm /1000) lb-in /1000	WEIGHT (Kg) Lbs	MOMENT (Kg-cm /1000) lb-in /1000
1	A/C Basic Empty Wt. (W.) (from page 6-5) (includes Full Oil) 8 Qts (7.57 Li) @ 1.875 Lbs/Qt (.80 Kg/Li) (Sta. -20.19) (-51.3 cm) (Oil sump assumed FULL for all flights)	(1009)	(114.6)		
		2225	99.46		
2	Pilot Seat (#1) *	(77.1)	(8.52) (aft pos)		
		170	7.40		
3	Co-Pilot Seat (#2) *	(77.1)	(7.25) (2nd. pos)		
		170	6.29		
3	Left Rear Seat (#3) or Cargo Area	(77.1)	(14.3)		
		170	12.41		
4	Right Rear Seat (#4) or Cargo Area	(77.1)	(14.3)		
		170	12.41		
4	Fuel (Max. Usable - 100.0 Gal/582.0 Lbs.) (378.5 Li/264.0 Kg.) @ Sta 49.23 (125 cm)	(164.7)	(20.59)		
		363	17.87		
5	Fuel (Max. Usable - 102.0 Gal/593.6 Lbs.) (386.1 Li/266.4 Kg.) @ Sta 49.23 (125 cm)	(164.7)	(20.59)		
		363	17.87		
5	Baggage (Max. 120 Lbs (54.4 Kg) @ Sta. 101.5 (257.8 cm)	(45.4)	(11.70)		
		100	10.15		
	Hat Rack (Max. 10 Lbs (4.54 Kg) @ Sta. 126.0 (320 CM)				
* Obtain the moment/1000 value for each seat position (FWD, MID or AFT) from loading computation graph.					
CONTINUE PROBLEM FORM ON NEXT PAGE					



PROBLEM FORM (CONT)

STEP	ITEM	SAMPLE PROBLEM		YOUR PROBLEM	
		WEIGHT (Kg) Lbs	MOMENT (Kg-cm /1000) lb-in /1000	WEIGHT (Kg) Lbs	MOMENT (Kg-cm /1000) lb-in /1000
6	Loaded A/C Weight (Takeoff at Max. Weight) A/C will have to burn off 168 Lbs fuel before normal landing is accomplished	(1528)	(191.1)		
		3368	165.8		
7	Required Fuel Burn- Off 32 Gals (121Li) @ 5.82 Lbs/Gal	(84.3)	(-9.53)		
		186	-8.27		
8	MAXIMUM LANDING WEIGHT of A/C	(1452)	(181.5)		
		3200	157.53		
9	Refer to Center of Gravity Moment Envelope, to determine whether your A/C loading is acceptable. CAUTION - DO NOT LAND A/C WHEN OVER 3200 LBS. EXCEPT IN AN EMERGENCY SITUATION.				

-CAUTION-

*Pilot is responsible for cargo loaded in rear seat area, with seat backs folded down.
Cargo Center of Gravity location varies with total weight loaded.
Compute CG value when cargo is loaded.*

LOADING COMPUTATION FORM

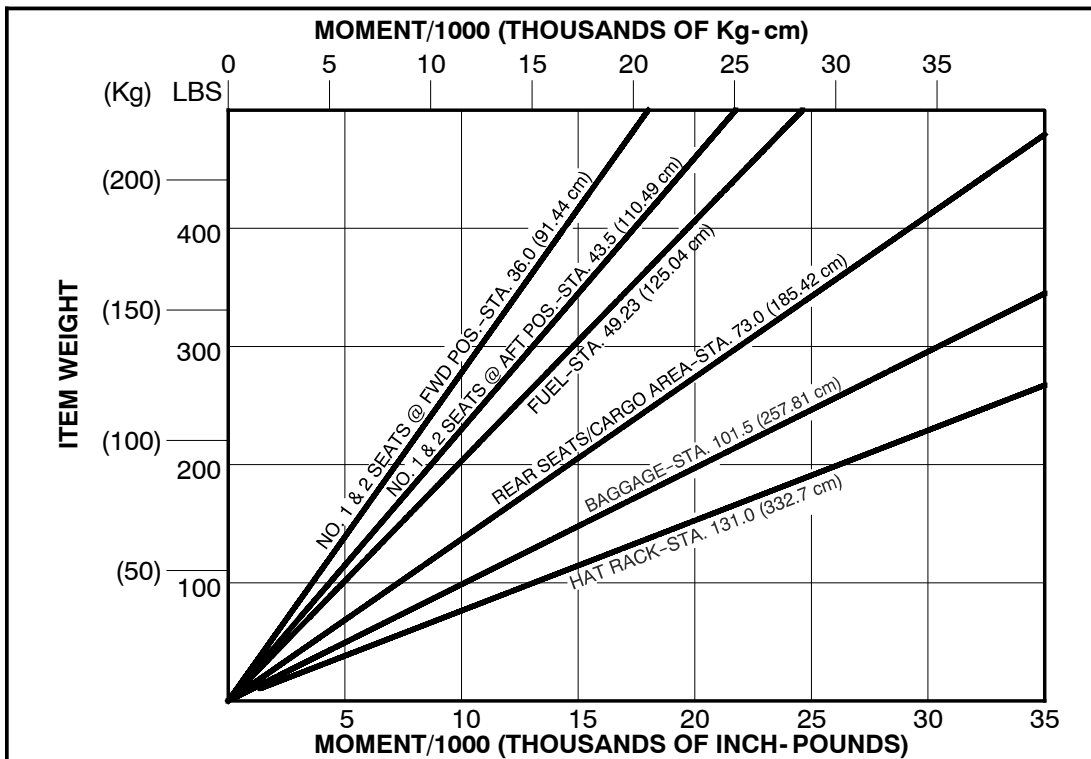

CENTER OF GRAVITY MOMENT ENVELOPE

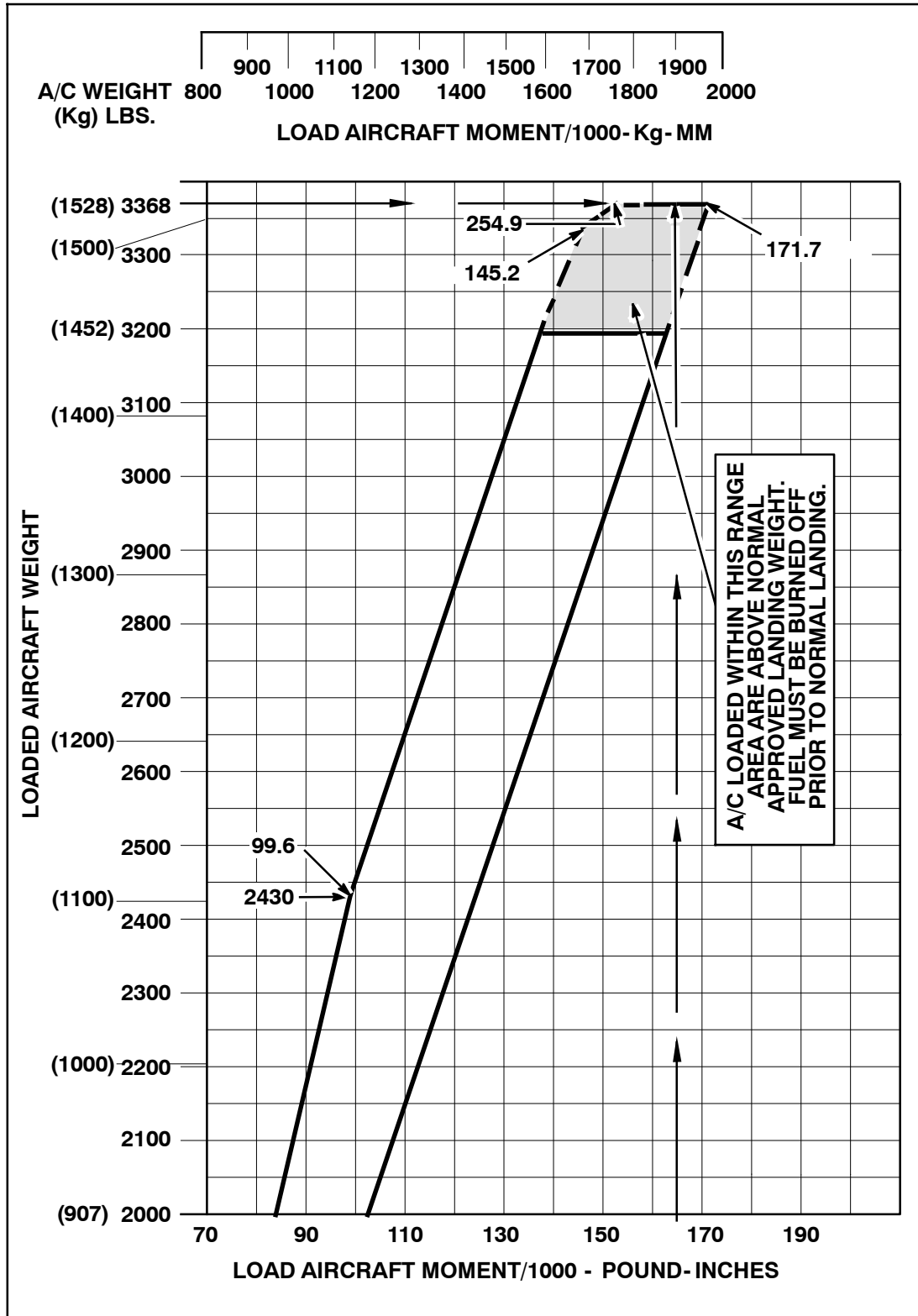

M20V - CENTER OF GRAVITY LIMITS ENVELOPE

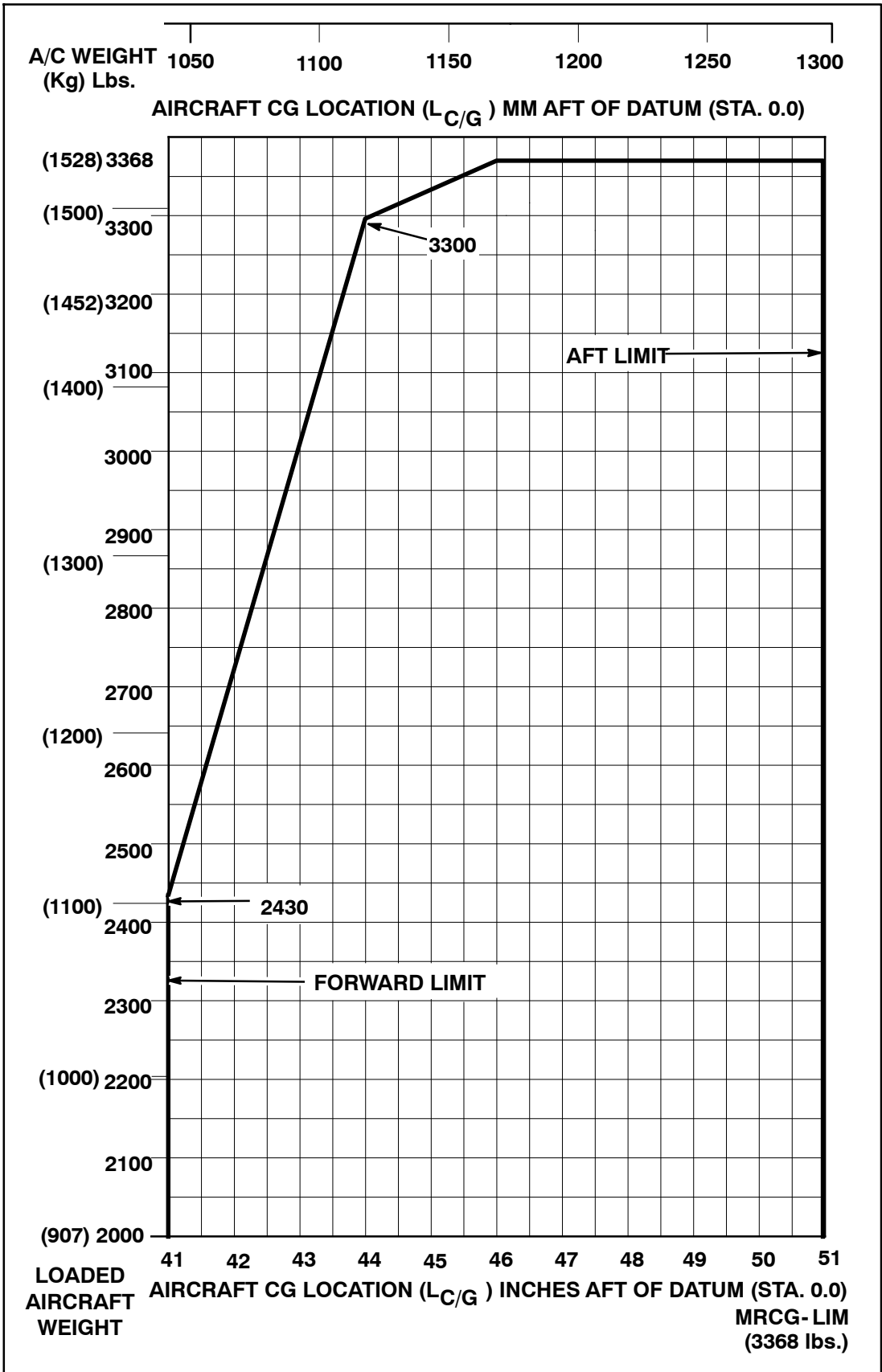

FIXED BALLAST

The M20V has provisions for a fixed ballast located in the tailcone at Fuselage Station 209.5. Some aircraft with TKS & other systems, may require all or a portion of the fixed ballast to be removed in order to stay within the weight and balance center of gravity envelope.

EQUIPMENT LIST

The following equipment list is a listing of items approved at the time of publication of this manual for the Mooney M20V.

Only those items having an X in the "Mark If Installed" column and dated were installed at Mooney International Corporation at the time of manufacture.

If additional equipment is to be installed it must be done in accordance with the reference drawing or a separate FAA approval.

-NOTE-

Positive arms are distances aft of the airplane datum. Negative arms are distances forward of the airplane datum.

Asterisks (*) after the item weight and arm indicate complete assembly installations. Some major components of the assembly are listed and indented on the lines following. The summation of the major components will not necessarily equal the complete assembly installation.



EQUIPMENT LIST									
ITEM NO.	ITEM DESCRIPTION	REF. DRAWING	WT.		ARM (INCHES)	MARK IF INSTALLED	MO.	DAY	YEAR
			(Kg)	(LBS)					
	A. FIXED BALLAST								
1A	WEIGHT (- 501 INSTL)	350203	(2.81)	6.2	(532.1)				209.50
2A	WEIGHT (- 503 INSTL)	350203	(6.08)	13.4	(532.1)				209.50
3A	WEIGHT (- 505 INSTL)	350203	(8.94)	19.7	(532.1)				209.50



EQUIPMENT LIST									
ITEM NO.	ITEM DESCRIPTION	REF. DRAWING	WT.		ARM (INCHES)	MARK IF INSTALLED	MO.	DAY	YEAR
			(Kg)	(LBS)					
	B. POWERPLANT & ACCESSORIES								
1B	ENGINE - CMI TSIO-550-G ()*; INCLUDES; STARTER, ALTERNATOR, EXHAUST, INDUCT. SYST., ALT. AIR, ENG. MT., FULL OIL, PROP. GOV	600292	(249.3)	549.5	(159.16) -23.29	X			
2B	PROPELLER * - CONSTANT SPEED: HARTZELL - PHC-J3YF-1RF/F7498 W/SPINNER	680038	(34.02)	75.0	(-125.7) -49.5				
3B	PROPELLER * - CONSTANT SPEED: HARTZELL - PHC-J3YF-1RF/F7498(B) (W/TKS Boots) W/SPINNER	680038	(34.02)	75.0	(-125.7) -49.5				
4B									
* Refer to Section I & II for engine/propeller configuration									



EQUIPMENT LIST										MO.	DAY	YEAR	MARK IF INSTALLED
ITEM NO.	ITEM DESCRIPTION	REF. DRAWING	WT. (Kg)	WT. (LBS)	ARM (cm)	ARM (INCHES)							
	B. POWERPLANT & ACCESSORIES (CONT.)												
5B	REIFF ENGINE HEATER	950303	(0.60)	1.31	(- 67.51)	-26.58							
6B													
7B													
8B													
9B													
10B													
11B													
12B													
13B													
14B													
15B													



EQUIPMENT LIST										
ITEM NO.	ITEM DESCRIPTION	REF. DRAWING	WT.		ARM (cm)	ARM (INCHES)	MO.	DAY	YEAR	MARK IF INSTALLED
			(Kg)	(LBS)						
	C. ELECTRICAL SYSTEM									
1C	BATTERIES, 24 VOLTS (2)	**	(13.4)	29.55	(370.8)	146.0				X
2C	REGULATOR, VOLTAGE (2)	**	(.27)	.6 EA	(41.28)	16.25				X
3C	PITOT, HEATED	**	(.52)	1.15	(106.3)	41.85				X
4C	POWER SUPPLY, AUX. EQUIP. (12V)	**	(.08)	.17	(49.53)	19.5				
5C	FUEL PUMP, ELECTRIC BOOST	**	(.86)	1.9	(38.1)	15.0				X
6C	STALL WARNING INDICATOR	**	(.45)	1.0	(127.0)	50.0				X
7C	GEAR WARNING INDICATOR	**	(.45)	1.0	(49.53)	19.5				X
8C	WING TIP STROBE LIGHT INSTL.	**	(2.27)	5.0	(134.62)	53.0				X
9C	TAIL STROBE LIGHT INSTL.	**	(.68)	1.5	(578.7)	227.82				X
10C	LANDING/TAXI LIGHTS (2 SETS)	**	(2.7)	5.88	(105.6)	41.6				X
11C	ACTUATOR, FLAPS	**	(2.3)	5.1	(277.1)	109.1				X
** REFER TO APPLICABLE A/C ELECTRICAL SCHEMATIC FOR COMPONENT INFORMATION										



EQUIPMENT LIST									
ITEM NO.	ITEM DESCRIPTION	REF. DRAWING	WT.		ARM (INCHES)	MO. DAY YEAR	MARK IF INSTALLED		
			(Kg)	(LBS)					
	C. ELECTRICAL SYSTEM (CONT.)								
12C	ACTUATOR, LANDING GEAR	**	(5.08)	11.2	(99.06)	39.0	X		
13C	E.L.T. (AMERI-KING) (AK-450)	810436	(1.41)	3.1	(429.0)	168.9			
14C	E.L.T. (ARTEX ME406)	810509	(1.85)	4.07	(378.84)	149.15			
15C	V. REG. (VOLT REG)	**	(1.36)	3.0	(40)	15.75			
16C									
17C									
18C							X		
19C									
20C									
** REFER TO APPLICABLE A/C ELECTRICAL SCHEMATIC FOR COMPONENT INFORMATION									



EQUIPMENT LIST							MO.	DAY	YEAR	MARK IF INSTALLED
ITEM NO.	ITEM DESCRIPTION	REF. DRAWING	WT. (Kg)	WT. (LBS)	ARM (cm)	ARM (INCHES)				
	D. WHEELS, TIRES & BRAKES									
1D	MAIN WHEEL & BRAKE DISC ASSYS (2)	520029	(6.46)*	14.24*	(163.57)	64.4			X	
	WHEEL ASSEMBLY (2)	520029	(4.53)	10.0	(162.51)	63.98			X	
	BRAKE DISC ASSEMBLY (2)	520029	(1.92)	4.24	(153.74)	60.53				
2D	TIRE, MAIN (6 PLY RATING) 6.00 X 6 TYPE III (2)	520029	(8.2)	18.0	(162.51)	63.98			X	
3D	NOSE WHEEL ASSEMBLY (1)	540000	(1.36)	3.0	(-33.8)	-13.3			X	
4D	TIRE, NOSE (6 PLY RATING) 5.00 X 5 TYPE III (1)	540000	(2.4)	5.3	(-33.8)	-13.3			X	
5D	MASTER CYLINDER, BRAKE (2)	850109	(1.81)	4.0	(21.08)	8.3			X	
6D	VALVE, PARKING BRAKE	850109	(.27)	.6	(-3.68)	-1.45			X	
7D	DUAL PUCK BRAKE CYL. ASSY (2)	520029	2.67	5.88	(168.48)	66.53			X	
8D										
9D										



EQUIPMENT LIST									
ITEM NO.	ITEM DESCRIPTION	REF. DRAWING	WT.		ARM (INCHES)	MO.	DAY	YEAR	MARK IF INSTALLED
			(Kg)	(LBS)					
	E. INSTRUMENTS								
1E	INDICATOR, TURN & SLIP/TURN COORD.	820358	(.83)	1.84	(41.91)			16.5	
2E	ALTIMETER	820358	(.49)	1.07	(36.0)			14.17	
3E	INDICATOR, AIRSPEED	820358	(.32)	.70	(47.75)			18.8	
4E	STANDBY ATTITUDE MODULE (SAM)	810535	(.73)	1.60	(54.86)			21.6	
5E	ANNUNCIATOR PANEL	820358	(.58)	1.3	(44.45)			17.5	X
6E	MAGNETIC COMPASS	820230	(.23)	0.5	(60.6)			23.87	X
7E	ALTERNATE STATIC AIR SOURCE	820360	(.14)	0.31	(44.99)			18.5	X
8E	ELECT., ARTIFICIAL HORIZON (3 IN.)	820336	(1.03)	2.3				17.5	
9E									
10E									
11E									
12E									



EQUIPMENT LIST										MO.	DAY	YEAR	MARK IF INSTALLED
ITEM NO.	ITEM DESCRIPTION	REF. DRAWING	WT. (Kg)	WT. (LBS)	ARM (cm)	ARM (INCHES)							
	E. INSTRUMENTS (CONT)												
13E													
14E													
15E													
16E													
17E													
18E													
19E													
20E													
21E													
22E													
23E													
24E													



EQUIPMENT LIST										MO. DAY YEAR	ARM (INCHES) (cm)	MARK IF INSTALLED
ITEM NO.	ITEM DESCRIPTION	REF. DRAWING	WT. (LBS) (Kg)	WT. (LBS) (Kg)	WT. (LBS) (Kg)	WT. (LBS) (Kg)	WT. (LBS) (Kg)	WT. (LBS) (Kg)	WT. (LBS) (Kg)			
	F. MISCELLANEOUS SYSTEMS											
1F												
2F												
3F												
4F												
5F												
6F												
7F												
8F												
9F												
10F												
11F												
12F												



EQUIPMENT LIST							MO. DAY YEAR	MARK IF INSTALLED
ITEM NO.	ITEM DESCRIPTION	REF. DRAWING	WT. (Kg)	WT. (LBS)	ARM (cm)	ARM (INCHES)		
	G. CABIN ACCOMODATIONS							
1G	SUN VISORS (2)	130250	(.32)	1.0	(83.8)	33.0	X	
2G	RESTRAINT ASSY, REAR (2)	140318	(2.27)	5.0	(194.3)	76.48	X	
3G	RESTRAINT ASSY, FWD (2)	140318	(2.27)	5.0	(106.7)	42.0		
4G	BOSE INTERFACE ()	810150	NEGLIGIBLE		***	***	X	
5G	AMSAFE V23 SYSTEM (2)	140345	(3.91)	8.61	FW- (137.92) AFT- (145.03)	54.3 57.1		
6G	AMSAFE V23 SYSTEM (4)	140345	(4.78)	10.53	FW- (137.92) AFT- (156.72)	54.3 61.7		
7G								
8G								
9G								
10G								
11G								
12G								



EQUIPMENT LIST

ITEM NO.	ITEM DESCRIPTION	REF. DRAWING	WT.		ARM (INCHES)	MARK IF INSTALLED
			(Kg)	(LBS)		
	H. AVIONICS & AUTOPILOTS					
1H	GARMIN G1000	950300	(38.08)	83.95	(208.28) 82.00	X
2H	GARMIN GDL 69/69A	950300	(1.28)	2.93	(350.01) 137.80	X
3H	GARMIN ADF	950300	(3.44)	7.59	(332.41) 130.87	
4H	KN 63 DME	950300	(1.36)	3.00	(321.82) 126.70	
5H	GARMIN GFC700 AUTOPILOT	830153	(7.82)	17.23	(288.04) 113.40	X
6H	SYNTHETIC VISION SYSTEM	810535				
7H						
8H						
9H						
10H						
11H						
12H						



EQUIPMENT LIST									
ITEM NO.	ITEM DESCRIPTION	REF. DRAWING	WT.		ARM (INCHES)	MARK IF INSTALLED	MO.	DAY	YEAR
			(Kg)	(LBS)					
	H. AVIONICS & AUTOPILOTS (CONT.)								
13H									
14H									
15H									
16H									
17H									
18H									
19H									
20H									
21H									
22H									



EQUIPMENT LIST										MO.	DAY	YEAR	MARK IF INSTALLED
ITEM NO.	ITEM DESCRIPTION	REF. DRAWING	WT. (Kg)	WT. (LBS)	ARM (cm)	ARM (INCHES)							
	I. AUXILIARY EQUIPMENT (FLY AWAY)												
11	TOW BAR, FOLDING (STOWED)	010037	(1.03)	2.6	(273.1)	107.5						X	
21	JACK POINTS (2) (STOWED)	010037	(.07)	.1	(332.7)	131.0						X	
31	EYE BOLT, WING TIE DOWN (2) (STOWED)	010037	(.09)	.1	(332.7)	131.0						X	
41	FUEL SAMPLER CUP (STOWED)	010037	(.04)	.05	(332.7)	131.0						X	
51	BAGGAGE TIE DOWNS (2) (STOWED)	010037	(.04)	.16	(332.7)	131.0						X	
61	CARGO RESTRAINT BELTS (2) (STOWED)	010037	(.27)	1.0	(332.7)	131.0						X	
71	PITOT COVER (STOWED)	010037	(.03)	.3	(332.7)	131.0						X	
81	POH/AFM NO. MOONEY	010037	(.84)	1.5	(332.7)	131.0						X	
91	ENGINE OPERATOR'S MANUAL - (CMI)	010037	(.35)	.5	(332.7)	131.0						X	
101	ENGINE LOG BOOK	010037	(.07)	.2	(332.7)	131.0						X	
111	AIRFRAME LOGBOOK	010037	(.063)	.2	(332.7)	131.0						X	
121													



EQUIPMENT LIST										MO.		
ITEM NO.	ITEM DESCRIPTION	REF. DRAWING	WT.		ARM (INCHES)	MARK IF INSTALLED	DAY					
			(Kg)	(LBS)			(cm)	YEAR				
	J. OPTIONAL EQUIPMENT											
1J	ARM REST INSTL, PILOT'S SEAT	140295	(.95)	2.1	(87.6)	34.5	X					
2J	LUMBAR SUPPORT INSTL. (2)	140300	(.99)	2.18	(88.9)	35.0						
3J	ACCESS PANEL, FUEL GAUGE (2)	210099	NEGLECTIBLE DIFFERENCE				X					
4J	STAND- BY ALTERNATOR	800379	(3.1)	6.8	(-11.89)	-4.68						
5J	RUDDER PEDAL EXTENSION INSTL. ()	720115	(.059)	.13	(38.1)	15.0						
6J	AUX. POWER RECEPTACLE INSTL.	800166	(1.48)	3.27	(332.7)	131.0						
7J	AUX. POWER CABLE ADAPTER	880042	(3.43)	7.57		****						
8J	DUAL BRAKE PEDAL INSTL.	950270	(1.38)	3.05	(38.1)	15.0						
9J	STATIC DISCHARGE INSTL. (STATIC WICKS)	950253	NEGLECTIBLE DIFFERENCE									
10J	STEPS ASSEMBLY/INSTAL.	950256	(2.49)	5.50	(274.3)	108.0						
11J	FIRE EXTINGUISHER INSTL.	130328	(1.20)	2.65	(153.7)	60.5						
**** NORMALLY STOWED IN BAGGAGE COMPARTMENT BETWEEN ST. 110 & 130												



EQUIPMENT LIST										MO.		
ITEM NO.	ITEM DESCRIPTION	REF. DRAWING	WT.		ARM (INCHES)	MARK IF INSTALLED				DAY		
			(Kg)	(LBS)						(cm)	YEAR	
	J. OPTIONAL EQUIPMENT (CONT.)											
12J	ANTI-COLLISION BEACON, FLASHING (RED)	950272	(.48)	1.06	(215.9)	85.0						
13J	REMOVEABLE STEPS ASSEMBLY	950301			274.3	108.0						
14J	HEADREST INSTL., REAR	140313/140323	(1.57)	3.47	(203.20)	80.0						
15J	HEADREST INSTL., FRONT	140313/140323	(1.57)	3.47	(114.3)	45.0						
16J	RECOGNITION LIGHT INSTL. (2)	210413	(.60)	1.32	(134.6)	53.0						
17J	DEFROSTER BLOWER	640315	(.39)	.87	(24.1)	9.5						
18J	3 PASSENGER, REAR, BENCH SEAT	140305	NO CHANGE		NO CHANGE							
19J	TKS AIRFRAME, WINGS ONLY (NO FLUID)	690007	(16.8)	36.5	(202.3)	79.6						
20J	TKS - A/F/WINGS/PROP - KNOWN ICE (NO FLUID)	690007	(18.1)	39.8	(203.5)	80.1						
21J	TKS - FLUID (TANKS FULL - 6.0 GAL.)	690007	(25.0)	55.2	(179.6)	70.7						
22J	50 GALLON CAPACITY USABLE FUEL TANKS (2)	210217			(125.04)	49.23						
23J												



EQUIPMENT LIST										MO.	DAY	YEAR	MARK IF INSTALLED
ITEM NO.	ITEM DESCRIPTION	REF. DRAWING	WT. (Kg)	WT. (LBS)	ARM (cm)	ARM (INCHES)							
	J. OPTIONAL EQUIPMENT (CONT.)												
24J	WX500 STORMSCOPE	810447	(1.52)	3.34	(374.45)	147.42							
25J	OXYGEN (77.1 Cu. Ft.) Precise Flight (Empty)	870032	(9.75)	21.5	(347.98)	137.0							
	OXYGEN (77.1 Cu. Ft.) Precise Flight (Full)	870032	(12.66)	27.9	(347.98)	137.0							
26J	AIR CONDITIONER (MINUS WTS.)	770000	(30.0)	66.1	(151.5)	59.7							
27J	SPEEDBRAKE 2000	950286	(4.1)	9.0	(180.3)	71.0							
28J													
29J													
30J													
31J													
32J													
33J													
34J													



EQUIPMENT LIST										MO.	DAY	YEAR	MARK IF INSTALLED
ITEM NO.	ITEM DESCRIPTION J. OPTIONAL EQUIPMENT (CONT.)	REF. DRAWING	WT. (Kg)	WT. (LBS)	ARM (cm)	ARM (INCHES)							
35J													
36J													
37J													
38J													
39J													
40J													
41J													
42J													
43J													
44J													
45J													
46J													



TABLE OF CONTENTS

TITLE	SECTION
INTRODUCTION	7-3
AIRFRAME	7-3
FLIGHT CONTROLS DESCRIPTION	7-3
AILERON SYSTEM	7-3
RUDDER SYSTEM	7-4
RUDDER TRIM SYSTEM	7-4
ELEVATOR SYSTEM	7-4
PITCH TRIM SYSTEM	7-4
WING FLAPS	7-4
INSTRUMENT PANEL	7-5
GARMIN G1000	7-5
FLIGHT PANEL & INSTRUMENTS	7-8
SWITCHES & CONTROLS	7-8
ANNUNCIATIONS OR ALERTS	7-13
GROUND CONTROL	7-15
NOSE GEAR STEERING	7-15
TAXIING AND GROUND HANDLING	7-15
LANDING GEAR	7-15
CONSTRUCTION	7-15
RETRACTION SYSTEM	7-15
WHEEL BRAKES	7-15
EMERGENCY EXTENSION SYSTEM	7-16
WARNING SYSTEM	7-16
CABIN	7-16
BAGGAGE COMPARTMENT	7-16
CARGO RESTRAINT	7-17
SEATS	7-18
SEAT BELTS/SAFETY HARNESS	7-18
DOORS, WINDOWS & EXITS	7-18
CABIN DOORS	7-18
PILOT'S WINDOW	7-18
EMERGENCY EXITS	7-18
ENGINE	7-19
GENERAL	7-19
ENGINE CONTROLS	7-19
ENGINE INSTRUMENTS	7-19
ENGINE OPERATION AND CARE	7-20
OIL SYSTEM	7-20
LUBRICATION SYSTEM	7-21
BREATHER FOR CRANKCASE	7-21
IGNITION SYSTEM	7-21
AIR INDUCTION SYSTEM	7-23
ICING PROTECTION	7-24



EXHAUST SYSTEM	7-24
FUEL INJECTION	7-24
ENGINE COOLING AIR	7-24
ENGINE STARTING SYSTEM	7-25
ACCESSORIES	7-25
EXHAUST GAS TEMPERATURE PROBE	7-25
TURBINE INLET TEMPERATURE (TIT)	7-25
PROPELLER	7-25
HARTZELL THREE BLADE	7-25
FUEL SYSTEM SCHEMATIC	7-26
FUEL SYSTEM	7-27
ELECTRICAL SYSTEM	7-27
ALTERNATOR & BATTERY	7-27
ESSENTIAL BUS	7-28
NON- ESSENTIAL BUS	7-28
EQUIPMENT LOCATION	7-28
■ SCHEMATIC	7-29
CIRCUIT BREAKER PANEL	7-30
ACCESSORIES	7-31
ANNUNCIATIONS AND ALERTS	7-31
LIGHTING SYSTEM	7-31
INSTRUMENT & PLACARD LIGHTS	7-31
MAP LIGHT	7-32
CABIN LIGHTING	7-32
EXTERIOR LIGHTING	7-32
CABIN ENVIRONMENT	7-33
HEATING & VENTILATION SYSTEMS	7-33
PITOT PRESSURE & STATIC SYSTEM	7-34
STALL WARNING SYSTEM	7-34
OXYGEN SYSTEM	7-35
VACUUM SYSTEM	7-35
EMERGENCY LOCATOR TRANSMITTER	7-35
ELT REMOTE SWITCH OPERATION	7-35



INTRODUCTION

Acquiring a working knowledge of the aircraft's controls and equipment is one of your important first steps in developing a fully efficient operating technique. This Airplane and Systems Section describes location, function, and operation of systems' controls and equipment. It is recommended that you, the pilot, familiarize yourself with all controls and systems while sitting in the pilot's seat and rehearsing the systems operations and flight procedures portions of this manual.

AIRFRAME

The M20V is a metal/composite, low wing, high performance airplane. The fuselage has a welded, tubular- steel cabin frame covered with non- structural composite and aluminum skin. Access to the cabin is provided by pilot and co-pilot side doors located on each side of the fuselage. A door is provided aft of the rear seat for access to the baggage compartment. The aft fuselage, tailcone, is of semi- monocoque construction.

Seating in the cabin is provided for the pilot and three passengers.

The M20V has a tapered, full- cantilever, aluminum construction, laminar- flow type wing. The airfoil varies from a NACA 63₂- 215 at the wing root to a NACA 64₁- 412 at the wing tip, modified by an inboard leading edge cuff. Wrap- around stretched formed skins cover the wing; flush riveting is used on the forward, top and bottom two thirds of the wing chord to provide benefit of laminar flow aerodynamics.

The empennage consists of the vertical and horizontal stabilizer assembly and the rudder and elevator surfaces. The entire empennage pivots around attaching points on the aft fuselage to provide pitch attitude trim.

The tricycle landing gear allows maximum vision and ground maneuvering. Hydraulic disc brakes and a steerable nose wheel aid in directional control during taxiing and ground operations. The landing gear is electrically retracted and extended. A gear warning VOICE ALERT, a gear position indicator on the floorboard and a green "GEAR DOWN" annunciation helps prevent inadvertent gear-up landings. A manual emergency gear extension system is provided in the event of electrical failure.

FLIGHT CONTROLS DESCRIPTION

The aircraft has dual flight controls and can be flown from either the pilot or co- pilot seat. Dual pairs of foot pedals control rudder and nose wheel steering mechanisms. Push- pull tubes actuate all- metal flight control surfaces. Rod- end bearings are used through out the flight control systems. These bearings are simple and require little maintenance other than occasional lubrication. Longitudinal pitch trim is achieved through a trim control system that pivots the entire empennage around tailcone attachment points.

AILERON SYSTEM

The ailerons are of all- metal construction with beveled trailing edges. Three hinges of machined, extruded aluminum attach each aileron to aft wing spar outboard of wing flaps. The ailerons link to the control wheel through push- pull tubes and bellcranks. Counterweights balance the ailerons. A spring- loaded interconnect device indirectly joins aileron and rudder control systems to balance in lateral stability during flight maneuvers.



RUDDER SYSTEM

The rudder attaches to the aft, vertical fin spar at four hinge points. Push-pull tubes and bellcranks link the rudder to the rudder pedals.

RUDDER TRIM SYSTEM

The M20V is equipped with an electric rudder trim system which allows the pilot to trim out much of the rudder force required for take off, climb, cruise and descent. The system is a “bungee” type spring assembly, attached to the rudder control system and driven by an electric motor. The trim system is operated by a spring loaded momentary switch, located above the throttle on the pilot’s panel. The momentary switch is a safety measure that greatly reduces the possibility of a run-away trim situation. Rudder force varies from negligible (with trim to the far right) to mild (with trim set to the third segment from the right). Cruise setting will result in the trim indicator being slightly left of neutral. A high speed descent will result in an even more left of neutral position. The Rudder Trim indicator is located on the Garmin GDU 10(XX) Multi-Function Flight Display (MFD). The indicator depicts the position (right/left) of the rudder trim setting. Actual trim position is shown using a blue inverted triangle. The “takeoff” rudder trim position is shown in white.

ELEVATOR SYSTEM

Elevator construction is essentially the same as that of the rudder. Both elevators attach to the horizontal stabilizer at four hinge points. Push- pull tubes and bellcranks link the elevators to the control wheel. A down- spring located in the tailcone and a bobweight located forward of the control column help create desirable stability characteristics. A factory set, fixed trim tab spans the length of the elevator. Counterweights balance the elevators.

PITCH TRIM SYSTEM

Pitch trim is electrically actuated with a split toggle switch on the control wheel for autopilot equipped aircraft. The pitch trim may be manually actuated by a wheel located on the floor between the pilot and co- pilot seat. Trim actuation turns a ball screw that increases or decreases the pitch angle of the entire empennage. The elevator trim position indicator (located on the MFD) depicts the position (up/down) of the pitch trim setting. Trim position is shown by a blue triangle. A white block indicates “take- off” pitch trim position.

WING FLAPS

The wing flaps are electrically operated and interconnected through a torque tube and bellcranks. Total flap area is 17.98 square feet.

Nominal travel is 0 to 33°. Limit switches prevent travel beyond these limits. Wing flap position is controlled by a pre- select switch located on the lower instrument panel. The flap position indicator (located on the MFD) shows the current position of the flaps. The three possible positions, up, take-off and down are depicted in cyan as “UP,” “T/O” and “DN,” respectively. During flaps position transition, “///” is displayed in the window. Generally, aircraft trim requirements will change with use of the flaps. Lowering of the flaps will cause a nose down pitching condition which can be easily corrected by application of nose up trim. Conversely, retraction of the flaps, from a trimmed flight condition, will cause a nose up pitching condition. Use of flaps should always be within the operational limits established in SECTION II. The flaps are very effective in lowering landing speed and can be used to slow the aircraft to approach speeds.



INSTRUMENT PANEL

The instrument panel has been designed to incorporate the G1000 Integrated Cockpit. All Communications, Navigation, Engine Instruments, and System annunciations have been integrated into a custom design package specifically for the M20V series aircraft.

Engine and electrical switches are located on the left side of the switch panel. Nav, strobe, recognition/landing and taxi light switches are located on the overhead switch panel.

Instrument panel lighting is provided by electroluminescent panels and post lights, overhead panel lights and the internally lighted G1000 Integrated Cockpit System. Optimum cockpit panel lighting for night flying is achieved by using a combination of panel lights and overhead map lights.

-NOTE-

The illustrations depict a standard panel configuration. The location of instruments, switches, and avionics may be relocated in each aircraft, dependant upon the optional equipment selected by the customer and available panel space.

GARMIN G1000

The GARMIN G1000 Integrated Avionics System consists of a Primary Flight Display (PFD), a Multi-Function Display (MFD), an Audio Panel, and Attitude and Heading Reference System (AHRS), an Air Data Computer (ADC), and the sensors and computers to process flight and engine information for display to the pilot. The system contains dual GPS receivers, dual VOR/ILS receivers, dual VHF communications transceivers, a transponder, and an integrated annunciation system to alert the pilot of certain abnormal conditions. The G1000 also has an integrated Garmin Flight Management System (FMS) controller known as "GCU 476 KEYPAD UNIT" - this provides alphanumeric, softkey, and flight planning function keys used to interface with a Garmin Integrated Flight Deck. The GCU 476 also provides heading, course, and altitude controls.

The Primary Flight Display (PFD) typically displays airspeed, attitude, altitude, and heading information in a traditional format. Slip information is shown as a trapezoid under the bank pointer. One width of the trapezoid is equal to a one ball width slip. Rate of turn information is shown on the scale above the compass rose; full scale deflection is equal to a standard rate turn. The following controls are available on the PFD (clockwise from top right):

- Communications frequency volume and squelch knob
- Communications frequency set knobs
- Communications frequency transfer button
- Altimeter setting knob (baro/QNH set)
- Course knob
- Map range knob and cursor control
- FMS control buttons and knob
- PFD softkey buttons, including master warning/caution acknowledgement
- Altitude reference set knob
- Heading bug control
- Navigation frequency transfer button
- Navigation frequency set knobs
- Navigation frequency volume and Identifier knob
- Autopilot controls located on the MFD/PFD Bottom LH side

The PFD displays the crew alerting system (G1000 Annunciations). When an alert message is received, an aural tone will be heard. Selecting the Alert button will allow the flight crew to see additional information regarding the alert message.

Trend vectors are shown on the airspeed and altimeter displays as a magenta line predicting 6 seconds at the current rate. The turn rate indicator also functions as a trend indicator on the compass scale.

The PFD can be displayed in a composite format for emergency use by pressing the DISPLAY BACKUP button on the audio panel. In the composite mode, the crew alerting function remains operative, but no map functions are available.



The Multi-Function Display (MFD) typically displays engine data, maps, terrain, traffic and topography displays, and flight planning and progress information. The display unit is identical to the PFD and contains the same controls as previously listed.

The audio panel contains traditional transmitter and receiver selectors, as well as an integral intercom and marker beacon system. The marker beacon lights appear on the PFD. In addition, a clearance recorder records the last 2 ½ minutes of received audio. Lights above the selections indicate what selections are active. Pressing the red DISPLAY BACKUP button on the audio panel causes both the PFD and MFD to display a composite mode.

The Attitude and Heading Reference System (AHRS) uses GPS, rate sensors, air data, and magnetic variation to determine pitch and roll attitude, sideslip and heading. Operation is possible in a degraded mode if the system loses any of these inputs, but the AHRS must have at least the ADC or GPS input to function. Status messages alert the crew of the loss of any of these inputs. The AHRS will align while the aircraft is in motion, but will align quicker if the wings are kept level during the alignment process.

The Air Data Computer (ADC) provides airspeed, altitude, vertical speed, and air temperature to the display system. In addition to the primary displays, this information is used by the FMS and TIS systems.

Engine instruments are displayed on the MFD. Discrete engine sensor information (oil pressure, manifold pressure, etc.) is processed by the GARMIN Engine Airframe (GEA) sub-system. When an engine sensor indicates a value outside the normal operating range, the legend will turn yellow for caution range, and turn red and flash for warning range.

The G1000 also interfaces to the GFC700 autopilot and repeats the autopilot mode annunciators on the G1000 PFD. This provides easy viewing of the autopilot operating mode and status, but remains a supplemental display of autopilot operating modes.

The GDL 69 Series are SiriusXM Satellite Radio data link receivers. The SiriusXM Satellite Radio antenna receives the SiriusXM satellite signal and passes it to the GDL 69 Series. The GDL 69/69H are weather data receivers only, and the GDL 69A/69AH are weather receivers, with the addition of SiriusXM Satellite Radio audio entertainment. For detailed operating instructions, see Garmin G1000 Cockpit Reference Guide for the Mooney M20V.

The TSO'd KN 63, if installed, is a complete 100 watt, 200- channel remote DME system. Distances up to 389 nm (at line- of- sight altitude), groundspeeds up to 999 knots and time- to- station up to 99 minutes are computed digitally and displayed on the G1000 PFD and controlled by the G1000 interface controls. Distance lock- on is virtually instantaneous (usually within one second) with accurate groundspeed and time- to- station readouts following in less than a minute. For detailed operating instructions, see Garmin G1000 Cockpit Reference Guide for the Mooney M20V.

The TSO'd Becker ADF 3502- (2) Automatic Direction Finder system, if installed, provides accurate bearing- to- station in the 200 kHz to 1799 kHz frequency range, complete with ADF, ANT and BFO tuning modes, plus audio output for station identification and monitoring AM broadcasts. It is displayed on the G1000 PFD and controlled by the PFD interface controls. For detailed operating instructions, see Garmin G- 1000 Cockpit Reference Guide for the Mooney M20V.

The "Optional" GTS 800 is a microprocessor- based Line Replaceable Unit (LRU) that uses active interrogations of Mode S and Mode C transponders to provide traffic advisories to the pilot. The advisory provided by GTS800 is independent of the air traffic control system which improves pilot situational awareness. The traffic information is displayed on the PFD and MFD via HSDB, refer to the Pilot's Guide and the Garmin G1000 Cockpit Reference Guide for the Mooney M20V.

Refer to the GARMIN G1000 Cockpit Reference Guide for the M20V MODEL aircraft, GARMIN P/N 190-02285-00, Rev. A or later FAA approved, for complete descriptions of the G1000 system and operating procedures.



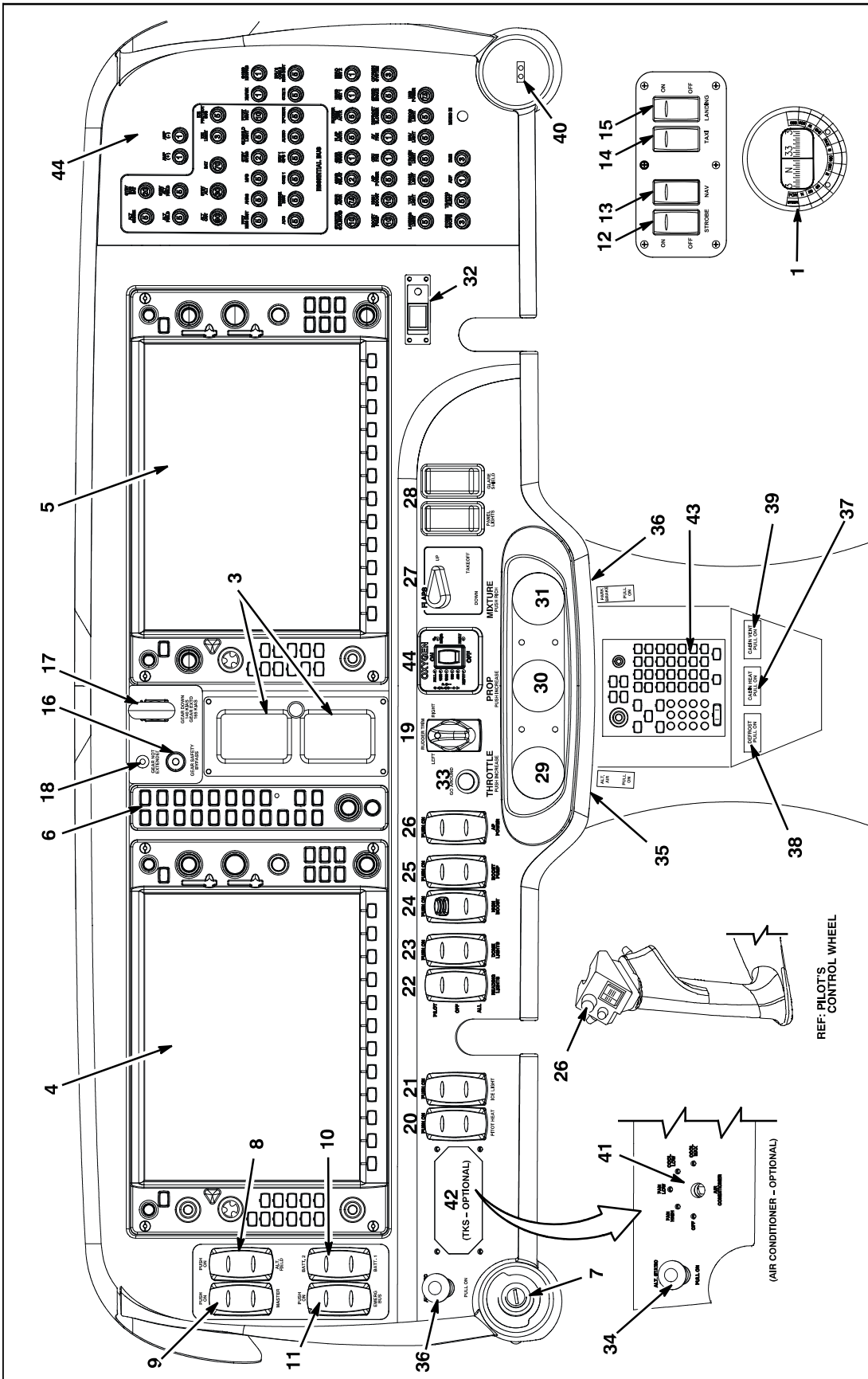

FIGURE 7-1 FLIGHT PANEL (33-0001 THRU 33-TBD)



FLIGHT PANEL & INSTRUMENTS

SWITCHES & CONTROLS

-NOTE-

The illustration depicts a standard panel configuration. The location of instruments, switches, and avionics may be relocated in each aircraft, dependant upon the optional equipment selected by the customer and available panel space.

1. MAGNETIC COMPASS

Magnetic compass dial is graduated in five-degree increments and is encased in liquid-filled glass and metal case. It is equipped with compensating magnets, adjustable from front of case. Access to compass light and compensating magnets is provided by pivoted covers. No maintenance is required on magnetic compass except an occasional check on a compass rose, adjustment of the compensation screws (if necessary) and replacement of the lamp.

2. HOUR METER (NOT SHOWN)

Hour meter - located on baggage compartment bulkhead indicates actual flight time and is triggered by the G1000 airspeed indication setting. Location may vary depending on installed systems.

3. STANDBY ATTITUDE MODULE (SAM)

Digital standby instrument to provide attitude, altitude, airspeed and slip information in an advanced 2-inch format. The self-contained, rechargeable, emergency battery offers pilots an increased level of security. In Pre-flight mode, the introduction screen will be displayed for approximately five seconds and will transition to Flight Mode when complete. In Flight Mode, the unit operates normally by displaying all four major functions: Attitude, Altitude, Airspeed and Slip Information.

ATTITUDE Indicator portion of the display will always appear on the top display. The Attitude Indicator consists of seven parts: Horizon Line, Sky (blue), Ground (brown), Symbolic Airplane, Roll Scale, Pitch Scale and Slip Indicator.

SLIP Indicator portion of the display will always appear at the bottom of the Attitude Display. The Slip Indicator is represented by a shaded translucent background with two white lines around center and a white ball. When the ball is maintained between the vertical lines during banking maneuvers, the turn is considered "coordinated" without slip.

ALTIMETER Indicator portion of the display will always appear on the bottom display. The Altimeter consists of four parts; Altitude Window, Altitude Tape, Barometric Setting Window and optional Altitude Trend Bar.

AIRSPEED Indicator portion of the display will always appear on the bottom display. The Airspeed Indicator Display consists of three parts; Airspeed Window, Airspeed Tape and Airspeed Limitations or Range Markings.

4. GARMIN GDU 10(XX) PRIMARY FLIGHT DISPLAY (PFD)

See description in "[Garmin G1000](#)" earlier in this section.

5. GARMIN GDU 10(XX) MULTI-FUNCTION FLIGHT DISPLAY (MFD)

See description in "[Garmin G1000](#)" earlier in this section.

6. GARMIN GMA 1347 AUDIO PANEL

See description in "[Garmin G1000](#)" earlier in this section.

7. MAGNETO/STARTER SWITCH

Magneto/Starter switch combines both ignition and starting functions. Turning ignition key clockwise through R, L, and BOTH to START position and then pushing forward on key and receptacle, engages starter. Releasing key when engine starts allows switch to return, by spring action, to BOTH position.

8. ALTERNATOR FIELD SWITCH

This switch cuts alternator field power from main buss to alternator.



9. MASTER POWER SWITCH

Master switch operates battery relay which controls battery power (selected battery) to main buss. This switch cuts ALL ship power OFF, except cabin overhead lights and baggage compartment light.

10. BATTERY SELECT SWITCH - BAT 1/BAT 2

This switch allows pilot to select either battery as primary for any flight. Battery #1 is normally used for operations. The battery not being used is recharged through a trickle charge system. It is recommended to switch batteries occasionally.

11. EMERGENCY BUS SWITCH (Optional when Stand-by Alternator is installed)

When Low Voltage annunciation illuminates, steady or flashing, pull 90A BAT circuit breaker and PUSH EMERG BUS switch ON to bring Stand-by Alternator online.

12. STROBE LIGHT SWITCH

Strobe light switch turns wing tip and tail strobe lights ON.

13. NAVIGATION LIGHT (NAV LITE) SWITCH

Navigation light switch turns wing tip and tail navigation lights ON.

14. TAXI LIGHT (TAXI LITE) SWITCHES (L & R)

15. LANDING LIGHT (LDG LITE) SWITCHES (L & R)

Select and push split switches to turn desired set of lights ON. Push switches OFF to turn desired set of lights off. Lights should be operated only for short time periods while not in flight to preclude overheating of lamps. Overload protection is achieved by circuit breakers in panel.

16. GEAR SAFETY BY PASS SWITCH (Gear Retraction Override)

Gear safety override switch is a manual means of electrically by-passing the Air speed Safety Switch. In the event the landing gear switch is placed in gear-up position, a properly operating Airspeed Safety Switch prevents gear from being retracted before take off speed of approximately 60 ± 5 KTS is reached. To retract landing gear at a lower air speed, the GR SAFETY BY PASS switch may be held de-pressed until landing gear is completely retracted.

-CAUTION-

Activation of landing gear safety override switch overrides the safety features of airspeed safety switch and CAN cause landing gear to start retracting while aircraft is on ground.

17. LANDING GEAR SWITCH

Electric gear switch, identified by its wheel shaped knob, is a two-position switch. Pulling aft and lowering knob lowers landing gear while pulling aft and raising knob raises landing gear.

-NOTE-

Failure to "Pull" knob out prior to movement may result in a broken switch.

18. GEAR DOWN POSITION INDICATOR

The gear-down position indicator, located on floorboard near back of fuel selector valve pan, aft of center console, has two marks that align when landing gear is down and illuminates when GREEN GEAR DOWN annunciation is ON. A red-white striped decal shows when landing gear is NOT in the down position.

19. RUDDER TRIM SWITCH

Spring loaded momentary switch to position rudder into trimmed condition to reduce rudder pedal forces during take off, climbs or descents. Right - take off and climbs; Left - descents. Turning left side of spring loaded switch trims rudder left, turning right side of switch trims rudder right.

20. PITOT HEAT SWITCH

Pitot heat SWITCH turns on heating elements within pitot tube. "PITOT HEAT" annunciation will illuminate "AMBER" only when failure occurs.



21. ICE LIGHT SWITCH (if Equipped)

Lighting to alert the pilot of ice formation on surfaces of an aircraft.

22. READING LIGHTS SWITCH

Momentary switch operates 4 overhead lamps in 3 modes. Reading Light Switch UP position, only the Pilot reading light is activated. With Reading Light Switch in Down position, ALL reading lights are activated. Passenger switches are located in the overhead panel.

23. DOME LIGHTS SWITCH

ON or OFF switch operates 1 main dome light in the center of overhead console.

24. "HIGH BOOST" FUEL BOOST PUMP SWITCH

The High Fuel boost pump switch operates the fuel boost pump on high power. The high boost setting is capable of operating engine at reduced power in case of engine driven fuel pump failure or severe fuel filter blockage. Selecting High Boost while Low Boost is powered on causes Low Boost to turn off. Continuous operation should be avoided except in an emergency. Never run the boost pump without fuel in the system.

-CAUTION-

Pushing HIGH BOOST pump switch ON when engine driven pump is operating properly will cause engine to quit due to excessive rich fuel mixture.

25. BOOST PUMP SWITCH (LOW BOOST)

The Low Fuel boost pump switch operates the fuel boost pump on low power to provide a means of suppressing fuel vapor from fuel system during hot day and high altitude conditions. Low boost may also be used as an engine starting aid. Continuous operation of the low boost is permitted. Never run the boost pump without fuel in the system.

-CAUTION-

Pushing LOW BOOST pump switch ON when engine is operating properly at idle conditions will cause engine to run rough or quit due to excessive rich fuel mixture. For this reason LOW BOOST should be turned off except where prescribed in the normal operating procedures.

26. AUTOPILOT POWER SWITCH

A manually operated rocker switch located on the instrument panel. This switch will provide power to the autopilot system and the Manual Electric Trim (MET). There is another disconnect using the MET and AP disconnect on the Pilot LH side control yoke. If the AP master switch is OFF, there will be an alert "FAILED PATH - A data path has failed".

27. WING FLAP SWITCH

Flap switch, on lower instrument panel, operates the electrically-actuated wing flaps. The flap switch incorporates a pre-select feature for TAKEOFF and FULL DOWN positions. Move switch down to first détente position to obtain TAKE OFF flaps (10°). Move switch to full down position to select FULL DOWN flaps (33°). When flap switch is moved UP to either TAKEOFF position or FULL UP position the flaps will retract to the selected position.

-CAUTION-

Positioning Flap Switch to the UP position retracts the flaps completely.

28. PANEL LIGHT AND GLARESHIELD SWITCH

Momentary light switch UP position will illuminate full strength or DOWN increases/decreases light intensity for the instrument panel area.

29. THROTTLE CONTROL

Push throttle control forward to increase engine power. Pull throttle aft to decrease engine power. Vernier control is optional.



30. PROPELLER CONTROL

Push propeller control forward to increase engine RPM; pull control aft to decrease engine RPM. Control is a vernier type and fine adjustments of RPM can be obtained by turning knob clockwise to increase RPM and counter clockwise to decrease RPM. Knob should not be turned IN any closer than .030" to .060" to panel nut face.

31. MIXTURE CONTROL

Mixture control allows pilot to adjust the fuel- air ratio (mixture) of the engine. Push control forward to enrich mixture. Pull control full aft to close idle cut off, shutting down engine. Control is a vernier type and fine adjustments of mixture can be obtained by turning knob clockwise to enrich mixture and counterclockwise to lean. Knob should not be turned IN any closer than .030" to .060" to panel nut face.

32. EMERGENCY LOCATOR TRANSMITTER (ELT) SWITCH

ELT is activated when the ON button is pushed. ELT returns to 'armed' condition when the RESET button is pushed. Refer to ELT description elsewhere in this section on proper and lawful usage.

ARTEX ELT (optional): If the ELT switch is labeled 'ARTEX ELT' then operation is different from above. ELT is activated when the switch is in the ON position. ELT returns to 'armed' the switch is in the ARMED position.

33. GO AROUND SWITCH

GO AROUND switch is activated when the GA button is pushed. Reference G1000 Pilot's Guide for more detailed information on system functionality.

34. ALTERNATE STATIC SOURCE VALVE

Pull alternate static source valve full aft to change source of static air for the altimeter, air-speed and vertical speed indicator from outside of aircraft to cabin interior. Air speed and altimeter readings are affected slightly when alternate static source is used (See Charts in SECTION V).

35. PARKING BRAKE CONTROL

Depress brake pedals and pull parking brake control to set parking brake. Push parking brake control in to release parking brake.

36. ALTERNATE AIR (ALT AIR)

The alternate air valve automatically opens when the primary induction air system becomes blocked for any reason. The valve may be opened manually by pulling the ALT AIR knob aft. An AMBER annunciation will illuminate when alternate air door is open.

37. CABIN HEAT CONTROL

Pull cabin heat control to turn cabin heat on. To lower cabin temperature, cabin heat control is pushed forward toward the OFF position. Optimum use of cabin heat control is described in the Cabin Environment Section.

38. DEFROST CONTROL

Pull defrost control to decrease air flow to lower cabin area and increase air flow to windshield ducts in the front of glareshield area. Optimum use of the defrost control is described in the Cabin Environment Section.

39. CABIN VENT CONTROL (Fresh Air)

Pull cabin vent control aft to open valve in mixing box connected to cabin air inlet vent located on the right side of the airplane. Optimum use of cabin vent control is described in the Cabin Environment Section.

40. ACCESSORY USB PORT

Universal Serial Bus: an external serial bus interface standard for charging peripheral personal devices; USB cable.

41. AIR CONDITIONING CONTROL (OPTIONAL)

See description in "Supplemental Section" in this POH/AFM.

42. TKS (OPTIONAL)

See description in "Supplemental Section" in this POH/AFM.



43. 476 KEYPAD UNIT

The GCU 476 refers to the Garmin Flight Management System (FMS) Controller used in a Garmin Integrated Flight Deck.

The GCU 476 Line Replaceable Unit (LRU) provides alphanumeric, softkey, and flight planning function keys used to interface with a Garmin Integrated Flight Deck. In addition to alphanumeric, softkey, and flight planning function keys the GCU 476 provides COM/NAV tuning capabilities. The GCU 476 mounts flush to the aircraft instrument panel using a jackscrew.

44. CIRCUIT BREAKER PANEL

See details elsewhere in this Section.

45. OXYGEN SELECTOR SWITCH - Precise Flight Oxygen System (Optional)

See description in "[Supplemental Section](#)" in this POH/AFM.

46. FUEL SELECTOR VALVE (NOT SHOWN)

Fuel selector valve, located on floorboard, is a three position valve which allows pilot to select either left or right fuel tank. Turning valve OFF, shuts off ALL fuel to engine. At full throttle engine will stop from fuel starvation in 2 to 3 seconds.

47. TRIM CONTROL WHEEL (NOT SHOWN)

Rotating trim control wheel forward lowers nose during flight; rearward rotation raises nose of aircraft during flight. If optional electric trim system is installed, pushing both sides of split trim switch, located on left hand portion of pilots control wheel, will electrically trim aircraft.

48. PILOT, CO- PILOT'S HEADSET JACKS, MIC JACK (Hand Held Microphone) and USB PORT (If installed) (NOT SHOWN)

Plug hand held microphone jack into this plug and place microphone in holder located on front of lower center console both LH and RH side.

49. OPTIONAL EQUIPMENT SWITCHES (If installed) (NOT SHOWN)

MAP LIGHT SWITCH/RHEOSTAT, MIKE SWITCH, ELECTRIC TRIM SWITCH (if installed), WX Clear (if installed) are located in the pilot's control wheel.





FIGURE 7-2 ANNUNCIATIONS

ANNUNCIATIONS AND ALERTS

ANNUNCIATIONS or ALERTS

GEAR SAFETY INDICATOR (GEAR DOWN - GEAR UNSAFE)

A GEAR DOWN annunciation “GREEN”, a GEAR UNSAFE annunciation “RED”, and a gear warning VOICE ALERT provide visual and audible gear position signals. The “GREEN” (GEAR DOWN) annunciation shows continuously when gear is fully extended. All gear annunciations are OUT when landing gear is fully retracted. Red “GEAR UNSAFE” annunciation displays during gear transition. Additional verification is accomplished by checking floor board indicator window.

SPEEDBRAKES

The Annunciation will illuminate “WHITE” after the SpeedBrake switch is depressed ON and both units are in the fully extended position. If the annunciation fails to illuminate and both SpeedBrakes do not extend after the switch is depressed ON, it indicates a failure of one of the SpeedBrake cartridges. The SpeedBrake switch should be depressed OFF. The system may be checked a second time for proper operation, but after the second attempt the SpeedBrake switch should be left OFF. When the SpeedBrake Switch is depressed to the OFF position, the annunciation will extinguish when both SpeedBrakes are fully retracted in the wing. The central - logic unit will disconnect the SpeedBrake clutch power to both SpeedBrake cartridges if one cartridge does not reach full extension. However, the drive motors will continue to operate until the SpeedBrake Switch is depressed OFF. The central - logic unit also disconnects clutch power if SpeedBrakes retract to within 10 degrees of the fully stowed position.

-NOTE-

A SpeedBrake cartridge that operates but does not fully retract flush with the wing surface is an indication of a failed cartridge clutch. Place the Speedbrake circuit breaker in the pulled position and have maintenance personnel inspect the system per Precise Flight SpeedBrake 2000 Maintenance procedures before any subsequent Speedbrake System Operation.



ALTERNATE AIR

Illuminates AMBER when the alternate air door is opened, either manually or automatically. In this situation, induction air for the engine is drawn from inside cowling rather than through the induction air intake. The normal induction air system **MUST** be checked, for proper operation, prior to next flight.

-NOTE-

Induction of alternate air (warm air) will result in loss of power.

PROP DEICE - (PROP DEICE is only an option for aircraft without TKS installed.)

Illuminates AMBER when PROP DEICE has been selected ON. If system is operating properly, the GREEN PROP DEICE switch lamp is illuminated, and the G1000 shows no annunciation. Amber PROP DEICE if the PROP DEICE switch is in ON position with Green PROP DE-ICE switch lamp illuminated, but PROP DEICE system has failed.

PITOT HEAT

If system is operating properly, the GREEN Pitot Heat switch lamp is illuminated, and the G1000 shows no annunciation. AMBER PITOT HEAT if the PITOT HEAT switch is in ON position with GREEN PITOT HEAT switch lamp illuminated, but Pitot Heat system has failed. PITOT HEAT will illuminate AMBER only when there is any type of electrical failure in the pitot heat system. It will not illuminate when switch is OFF and will not illuminate when switch is ON and current is flowing through pitot heater.

ALTERNATOR VOLTS

A RED annunciation indicates improper voltage supply. RED ALTERNTR FAIL on G1000 Display when Alternator output goes to zero, or when Field shorts. NOTE: Voltmeter on MFD Display flashes YELLOW when bus voltage drops below ~@24.5VDC whether alternator has failed or not.

START POWER

Illuminates RED when the starter switch is engaged or relay has malfunctioned and the starter is engaged while the engine is running. Shut the engine off as soon as practicable.

EMERGENCY BUS

AMBER EMERGENCY BUS Displayed on G1000 when EMERGENCY BUS switch is selected ON. GREEN lamp on Emergency Bus switch when switch is selected ON

DOOR OPEN

RED DOOR OPEN Displayed on G1000 when either cabin door(s) or baggage door is not shut.

LOW BOOST PUMP

GREEN lamp illuminated on LOW BOOST Switch. WHITE low boost illuminated on G1000 Annunciation.

HIGH BOOST PUMP

AMBER HIGH BOOST Displayed on G1000. NOTE: The HIGH BOOST switch has a thumb lock-out to prevent accidental operation instead of a green lamp.

SWITCH PANELS & ANNUNCIATOR PANELS MAY VARY WITH AIRCRAFT



GROUND CONTROL

NOSE GEAR STEERING

Nose gear steering system consists of a steering horn on the nose gear leg linked to the rudder pedals by push-pull tubes. Rudder pedal action steers the nose wheel. Gear retraction relieves the rudder control system of its nose wheel steering and centers wheel to permit retraction into the nose wheel well. Minimum turning radius on the ground is 40 feet (12.0 m) to the right and 48 feet (14.4 m) to the left. Adjustable steering stops have been incorporated on nose gear leg assembly.

-CAUTION-

The nose wheel must not be swivelled beyond 11 ° left or 13 ° right of center. To exceed these limits may cause structural damage.

TAXIING AND GROUND HANDLING

The aircraft can be easily taxied with minimum use of brakes. Minimum turning radius is 40 ft. (12.0 m) right & 48 ft. (14.4 m) left, without use of brakes. A MANUAL towbar is provided to ground handle aircraft. Care must be used to not swivel nose wheel beyond 13 ° right or 11 ° left from center. Adjustable steering stops are incorporated on nose gear leg assembly.

-CAUTION-

Exceeding steering swivel angle limits may cause structural damage.

LANDING GEAR

CONSTRUCTION

Landing gear legs are constructed of chrome-molybdenum tubular steel, heat-treated for greater strength and wear resistance. Main gear leg attaching points pivot in bearing surfaces on forward and stub spars. The nose gear mounts on cabin tubular steel frame. Rubber discs in all gear leg assemblies absorb shock of taxiing and landing.

RETRACTION SYSTEM

Landing gear is electrically retracted and extended. The landing gear switch operates a landing gear actuator relay. Pull wheel-shaped knob out and move it to upper déteinte to raise landing gear. An Airspeed Safety Relay, connected to the airspeed indicator, is incorporated into the Garmin G1000 system and alerts the pilot to prevent landing gear retraction while on the ground and until a safe takeoff speed (approximately 70 ± 5 KTS) is reached. A properly rigged up-limit switch will stop landing gear in its retracted position. Move control knob to its lower déteinte to lower landing gear. A properly rigged down-limit switch will stop landing gear actuating motor when proper force has been exerted to hold landing gear in the down-and-locked position. Bungee springs pre-load the retraction mechanism in an over center position to assist in holding landing gear down. A landing gear safety by-pass switch override is provided, next to the gear switch, to allow the landing gear to retract for maintenance purposes. Depress and hold this switch to manually by-pass airspeed safety relay and allow landing gear to retract. The electrical extension or retraction system will not operate if the manual extension lever is not properly positioned down (refer to Emergency Extension System section).

-CAUTION-

Never rely on airspeed safety relay to keep landing gear down during taxi, takeoff or landing. Always make certain that landing gear switch is in down position during these operations.

WHEEL BRAKES

Main gear wheels incorporate self-adjusting, disc-type, dual puck, hydraulic brakes. The pilot's rudder pedals have individual toe-actuated brake cylinders linked to the rudder pedals. Depress-



ing both toe pedals and pulling parking brake control, on console, sets the brakes. Push parking brake control forward to release brakes. It is not advisable to set parking brake when brakes are overheated, after heavy braking or when outside temperatures are unusually high. Trapped hydraulic fluid may expand with heat and damage the system. Wheel chocks and tie downs should be used for long-term parking.

EMERGENCY EXTENSION SYSTEM

A manual, emergency gear extension mechanism is provided to allow emergency lowering of landing gear. The control mechanism is located between and aft of pilot and co-pilot seats. The RED lever must be released and pulled up (rotated aft) to engage the manual emergency extension mechanism. The mechanism has a spring retracted pull cable which manually drives the gear actuator to extend landing gear. 12- 20 pulls are required to fully extend and lock landing gear down. The electrical extension or retraction system will not operate if the manual extension lever is not properly positioned down.

WARNING SYSTEM

The landing gear warning system consists of:

1) landing gear condition annunciations, GREEN for "GEAR DOWN" and RED for "GEAR UNSAFE", and

2) VOICE ALERT, activated when landing gear is not down-and-locked and throttle is approximately 1/4 inch from idle position. The green annunciation shows continuously when landing gear is fully extended. The red annunciation shows when ever landing gear is in transit or not locked down but is OFF when landing gear is fully retracted. A visual gear-position indicator, located on floorboard, aft of the fuel selector, shows that landing gear is down when indicator marks align. The gear down annunciation is dimmed when navigation lights are turned on.

CABIN

BAGGAGE COMPARTMENT

The baggage compartment is located aft of rear passenger seats. The standard compartment has 20.9 cubic feet (0.59 cu.m.) of baggage or cargo space. A maximum of 120 pounds (54 Kg) may be loaded in this area. There are floor tie down straps provided. Passengers should not be allowed to occupy this space.

Additional cargo space is available by folding rear seats down. To fold seats down remove rear seat bottom cushion. Pull seat back release handle and fold seat back forward, pull Velcro attachment loose, and slide seat cover UP and OFF frame. Fold the seat backs the rest of the way down. Store the cushions as desired. Reverse the procedure to re-install.

Seat back frames may also be removed for additional space. To remove frame fold rear seat back forward, pull Velcro attachment loose, and slide seat cover UP and OFF frame. Pull the lock pin on the left side of each frame then pull seat frame from pivot rods. Pull seat back release handle UP and push pivot rods forward & down into seat cushion cavity. Reverse the procedure to re-install.

Both rear seats can be folded down and/or removed together or independent of each other.

The storage area located aft of the top of the aft baggage compartment bulkhead (hat rack) is restricted to 10 pounds (4.5 Kg).



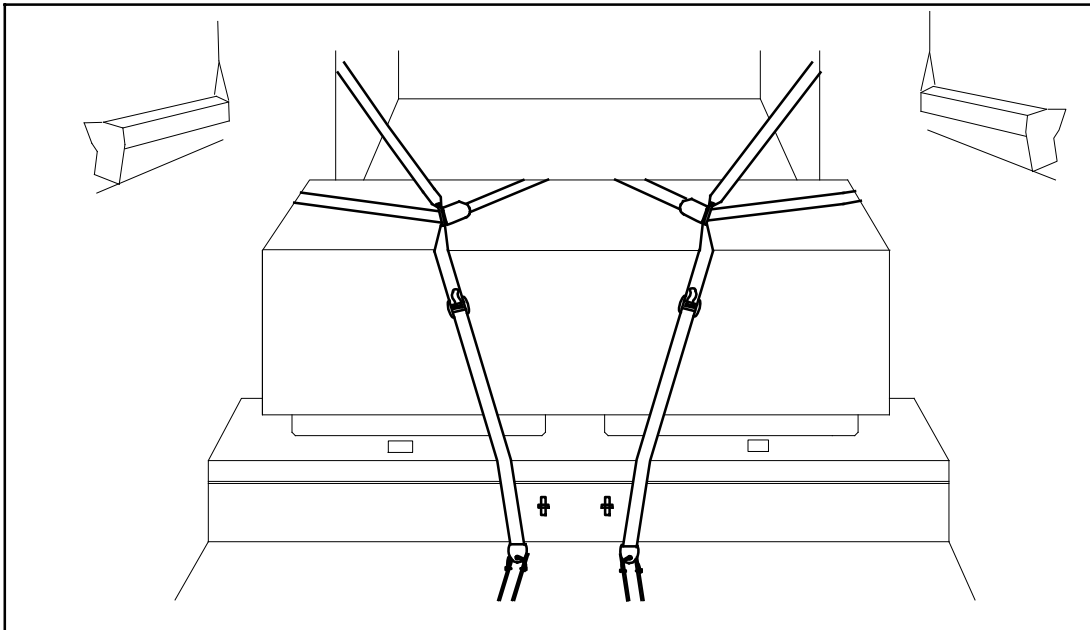

FIGURE 7-3 CARGO RETENTION (TYPICAL)

CARGO RESTRAINT

Cargo tie down rings/clevis pins are to be inserted into holes provided in web of front seat rails. The cargo belts attach to these rings and to standard seat belt harness to retain cargo. Refer to Figure 7-3 for typical restraint.

Proper loading and retention of cargo is mandatory. See [Loading Computation Graph](#), SECTION VI.

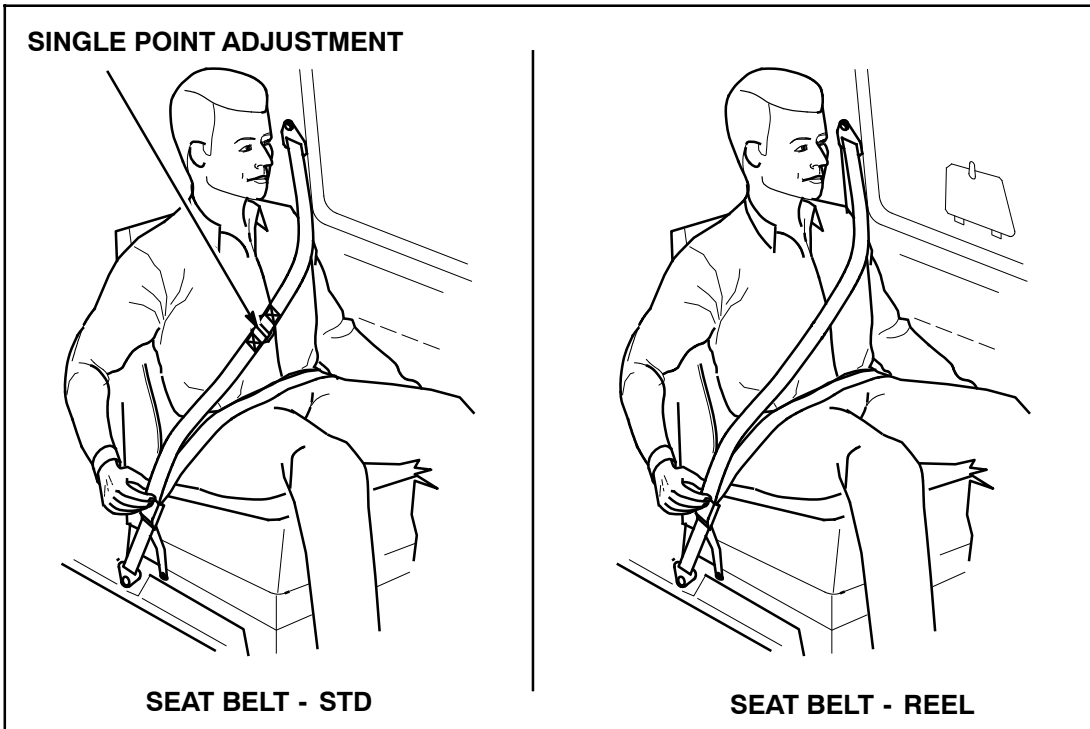

FIGURE 7-4 INERTIAL REEL/HARNESS RETENTION



SEATS

The front seats are individually mounted and may be adjusted fore and aft to fit individual comfort preferences. The front seat back may be adjusted by turning left side hand crank (knob) until seat back is in desired position. Both optional front seat configurations allow vertical seat height adjustment by turning right side hand crank to raise or lower the entire seat assembly. The rear seat backs have four (4) adjustment positions. Each seat can be adjusted independent of the other by pulling up on respective release handle located on left or right of aircraft centerline on forward spar. This allows adjustments from approximately 10° to 40° recline position.

SEAT BELTS/SAFETY HARNESS

Safety restraints, if worn properly, (1 occupant per restraint) keep occupants firmly in their seats during T/O, landing, turbulent air and during maneuvers. The belts/harnesses are mechanically simple and comfortable to wear. The front seat inertia belts/harnesses are attached to hard points on side structure and seats. The rear seat belts are attached to brackets firmly mounted to structural hard points. Shoulder harnesses are provided for rear seat occupants. Safety belts/harnesses **MUST** be fastened for take-off and landing operations. It is recommended that all infants and small children below 40 lbs. weight and/or under 40 in. height be restrained in an approved child restraint system appropriate to their height and weight. The single diagonal type safety harness is designed so the chest strap crosses diagonally from the outboard shoulder to an attachment point as low on the inboard hip as possible. Rear seat occupants should take care to conform with this procedure in adjusting chest strap and inboard belt length. This diagonal configuration places body center-of-gravity inside the triangle formed by chest strap and lap belt. The lap belt should be adjusted comfortably tight. As a result, the body is restricted from rolling out toward the unrestricted shoulder or “open” side of the harness, upon forward impact. Refer to Figure 7- 4 for proper seat belt/harness adjustment.

The AAIR V23 is a self-contained, modular, three-point restraint system that improves protection from serious head impact injury during a survivable aircraft crash by inclusion of an inflatable airbag to the lap belt portion of the three point restraint.

The AAIR V23 system is activated when the buckle's are joined [buckled] together at each seat location.

DOORS, WINDOWS & EXITS

CABIN DOORS

Access into cabin is provided by a door located on left and right side of fuselage. These doors have inside and outside operating handles. The outside door handle can be locked with a key specifically provided for it. Each door has two latching pin mechanisms, one located at the top of door and one at the aft, center of door.

Should any of the doors come open in flight, flying qualities of the aircraft will not be affected. Procedures for closing door in flight are contained in [SECTION III](#).

PILOT'S WINDOW

A pilot's storm window is located in the left main cabin window. This window is generally used for fresh air for prolonged ground operations or as required during adverse weather conditions. The window should not be opened in flight above 132 KIAS.

EMERGENCY EXITS

Both CABIN DOORS are the primary emergency exit from the cabin. If a situation exists where a probable off airport landing will occur, the door should be unlatched to prevent jamming during landing.

The BAGGAGE compartment access DOOR can be used as an auxiliary exit. The door can be opened from the inside even though locked. To open, pull off small ABS cover, pull out latch pin and pull Red Handle.



To verify re-engagement of latching mechanism; open outside handle fully, close inside handle to engage pin into cam slide of latch mechanism; insert latch pin into shaft hole to hold Red Handle down. Replace ABS cover. Operate outside handle in normal method.

ENGINE

GENERAL

The engine installed is a Continental Motors Inc. TSIO 550- G(*), turbocharged, fuel injected engine. The following designation describes engine:

TS Denotes "TURBO- SUPERCHARGED"
I Denotes "FUEL INJECTED"
O Denotes "OPPOSED" (refers to the horizontally opposed cylinders)
550 Denotes piston displacement in "CUBIC INCHES"
G (*) Denotes a specific equipment configuration

* Refer to TCDS for engine configuration required.

The TSIO-550-G has twin turbochargers which use exhaust gas flow to boost induction air pressure for increased power. There is one turbocharger on each side of the engine. The turbochargers compress and raise the temperature of the incoming air before going to the intercoolers. The compressed air runs through the intercoolers where it is cooled down before entering the throttle body and cylinders. The dual turbochargers are lubricated from external oil supply lines from a source at the bottom of the oil cooler. There is one oil pressure actuated wastegate on the left side of the engine controlling the amount of exhaust gas used by the turbochargers. Control is accomplished by a diaphragm actuated valve sensing differential pressure across the throttle plate and controlling the oil return flow rate from the wastegate. An overboost valve in the induction system provides protection from too much pressure by actuating at 35 in Hg of manifold pressure.

The engine operates with three, standard engine controls. The propeller turns clockwise as viewed from the cockpit.

ENGINE CONTROLS

The engine controls are centrally located between the pilot and co- pilot on the lower middle instrument panel. The BLACK throttle knob regulates manifold pressure; push the knob forward to increase the setting; pull the knob aft to decrease the setting.

The propeller control, with its crowned BLUE knob, controls engine RPM through the propeller governor. Push the knob forward to increase engine RPM; pull the knob aft to decrease RPM.

The mixture control, with its RED fluted knob, establishes the fuel- air ratio (mixture). Push the knob full forward to set the mixture to full- rich, pull the knob gradually aft to lean the mixture. Pull the knob to its maximum aft travel position to close the idle cut- off valve to completely shutdown the engine. Precise mixture settings can be established by observing the TIT gauge on the pilot's instrument panel while adjusting the mixture control.

The throttle, propeller and mixture controls are vernier type and fine adjustment can be made by turning knobs clockwise or counter- clockwise. The vernier controls should be rigged within .030 to .060 in. from panel nut face. Rapid movement or large adjustments can be made by pushing button on end of control and positioning control where desired. The non- vernier throttle has an integral friction device.

ENGINE INSTRUMENTS

Engine instruments operate electrically, except manifold pressure, through variations in resistance caused by pressure or temperature changes or by variations in current output caused by varying engine RPM or alternator output. The tachometer receives its signal from the Hall effect sensor in magneto.



Engine operating instruments are displayed in the Garmin GDU 10(XX) Multi- Function Display. Colored bars on instrument faces mark operating ranges. Proper interpretation of engine instrument readings is essential for selecting optimum control settings and for maintaining maximum cruise fuel economy. (Refer to [SECTION II](#) for Limitations).

ENGINE OPERATION AND CARE

Life of an engine is determined by the care it receives. Maximum efficiency and engine service life can be expected when a good maintenance program is followed. Poor maintenance results in faulty engine performance and reduced service life. Efficient engine operation demands careful attention to cleanliness of air, fuel, oil and maintaining operating temperatures within required limits. Servicing of the engine should be accomplished only by qualified personnel. The minimum grade of fuel for this engine is 100LL or 100 octane aviation gasoline. Operational procedures for adverse environmental conditions can be found in engine maintenance and operator's manual.

OIL SYSTEM

The engine has a full- pressure, wet sump oil system with an 8 quart (7.57 liters) capacity. A conventional dipstick is provided for determining oil quantity. The oil system is depicted in Figure 7- 5. The propeller governor boosts engine oil pressure for operation of the propeller. It controls oil pressure going to the propeller hub to maintain or change propeller blade angles. This oil flows through propeller shaft to reach the propeller.



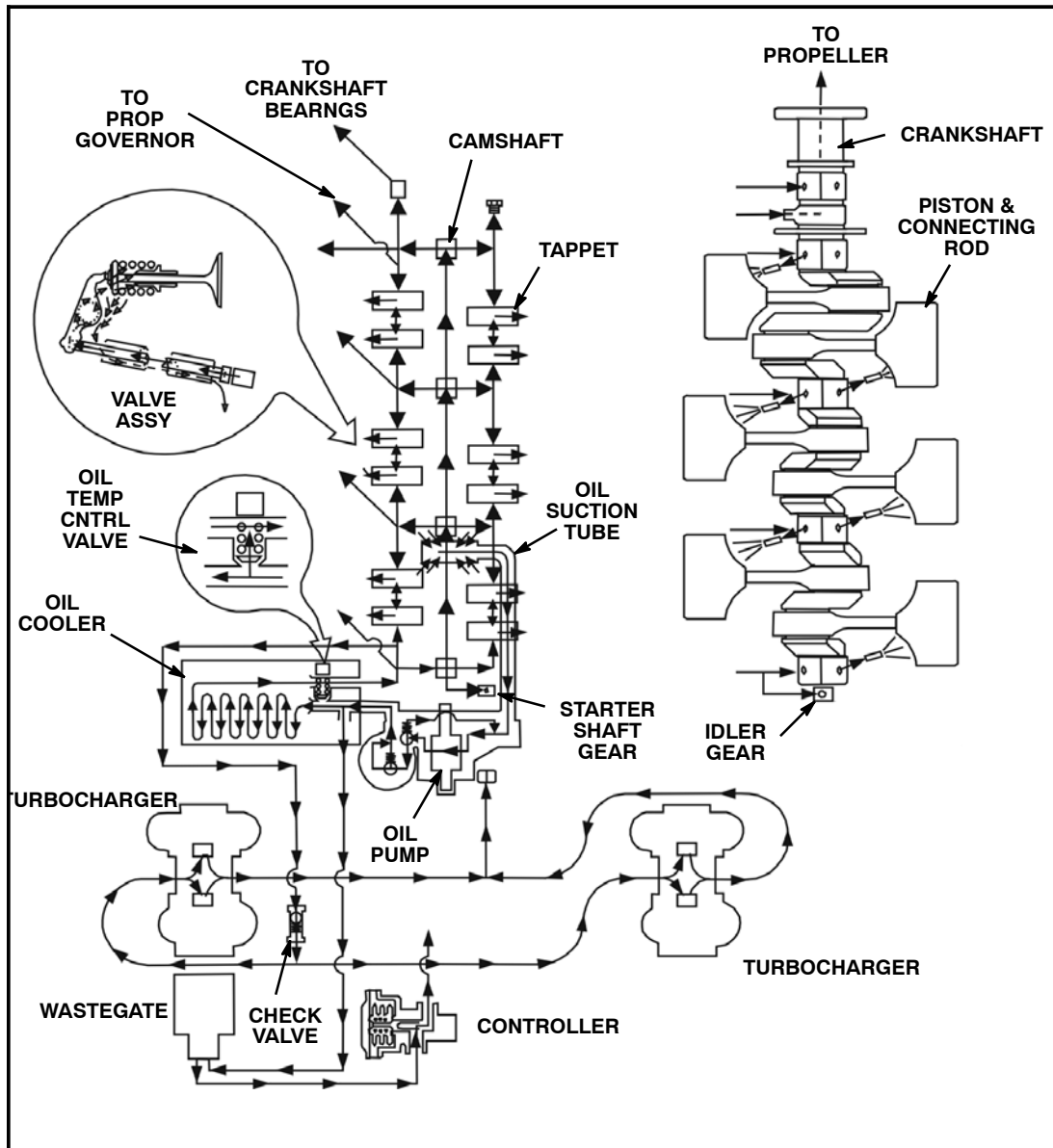

FIGURE 7-5 OIL SYSTEM SCHEMATIC

LUBRICATION SYSTEM

Oil Filter - Full flow oil filter is a throw away filter element with a bypass valve incorporated.

BREATHER FOR CRANKCASE

The crankcase is vented overboard through an air-oil separator to a “C” shaped standpipe mounted in the left wheel-well area. The air oil separator condenses some of the oil vapor and returns the oil back to the crankcase. Proper maintenance of this system is required to minimize oil consumption.

IGNITION SYSTEM

The TSIO-550-G engine is equipped with pressurized magnetos with impulse couplings on each magneto.

Power from the engine crankshaft is transmitted through camshaft gear to the magneto drive gears, which in turn drives the magneto drive couplings. The left magneto incorporates an impulse coupling. As the rubber bushings in the drive gear turns the coupling drive lugs, counter-weighted latch pawls inside the coupling cover, engage pins on the magneto case and hold back the latch plate until forced inward by the coupling cover. When the latch plate is released, the



coupling spring spins the magneto shaft through its neutral position and the breaker opens to produce a high voltage surge in the secondary coil. The spring action permits the latch plate, magnet and breaker to be delayed through a lag angle of 30 degrees of drive gear rotation during the engine cranking period. Two lobes on the breaker cam produce two sparks per revolution of the drive shaft. After engine is running, counter-weights hold the latch pawls away from the stop pins and the magneto shaft is driven at full advance.

The engine firing order is 1-6-3-2-5-4. Ignition harnesses are connected to the magnetos so right magneto fires the upper plugs on the right side and lower plugs on the left. The left magneto fires the upper plugs on the left and lower plugs on the right. The magneto cases, spark plugs, harnesses and connections are shielded to prevent radio interference.



AIR INDUCTION SYSTEM

The primary engine air induction system draws air from the upper cowl plenum through the engine cooling inlets. The air passes through a filter and is split to provide air to the left and right turbo. The standard air filter is cleanable and must be serviced at 100 hour intervals. Refer the service and maintenance manual for instructions.

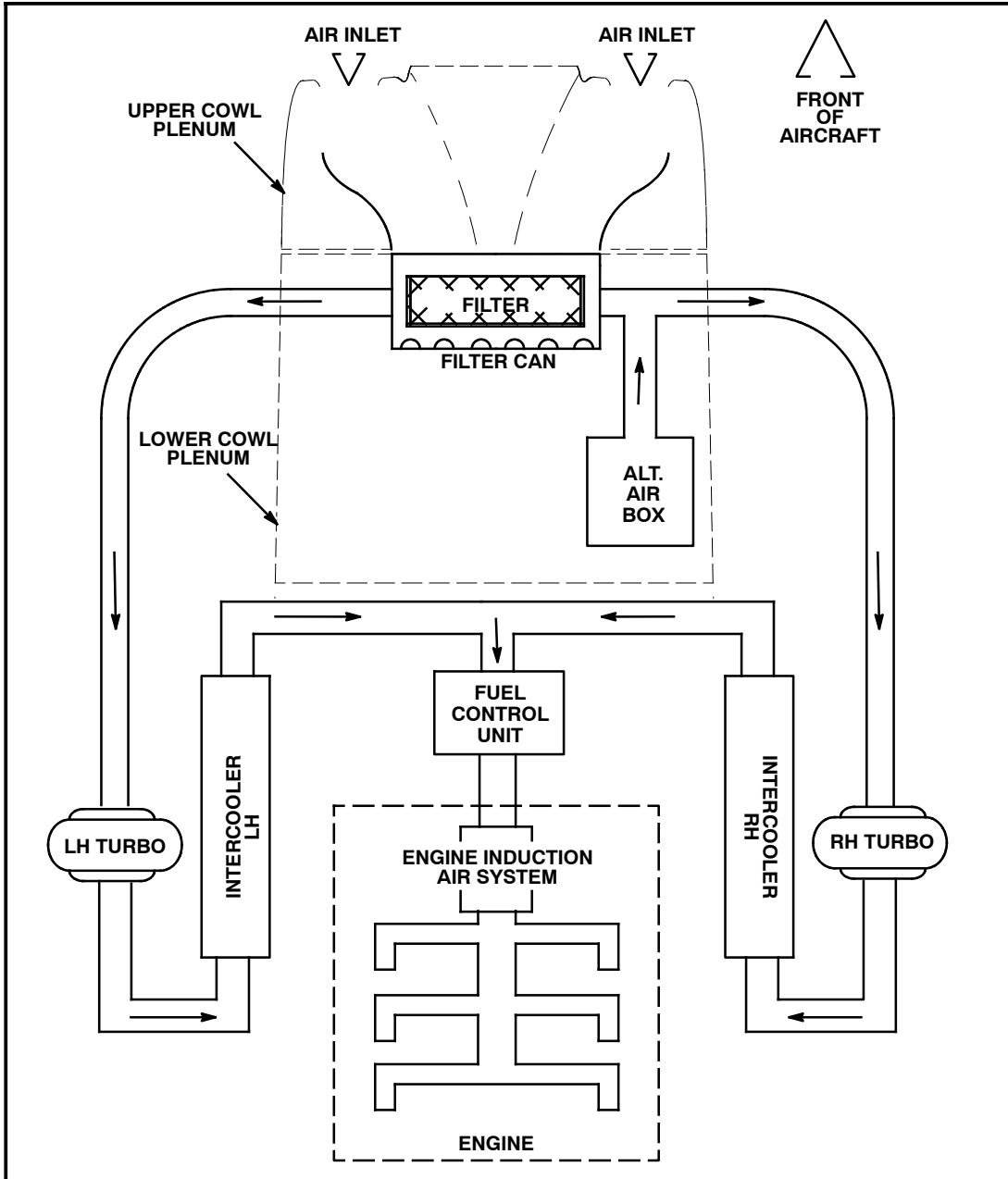

FIGURE 7-6 AIR INDUCTION SYSTEM SCHEMATIC

A secondary or alternate air source for combustion air is provided. It has a door which normally remains closed and is held by a magnetic catch. If the air filter or induction air inlet is restricted beyond a minimum allowable inlet pressure, the alternate air door will automatically open. Warmer air will then be drawn from the engine compartment. There will be a reduction of engine power when the alternate air door is open due to lower inlet air pressure and higher air temperature. Whenever the alternate air door is open, a switch will activate the "ALT AIR" annunciation on the panel to alert the pilot.



ICING PROTECTION

Continued operation of the induction system in the event of intake air being obstructed is provided by activation of the alternate air system. The alternate air is automatically or manually controlled. When the door is opened, unfiltered, relatively warm air, from engine compartment, is admitted into the induction system.

EXHAUST SYSTEM

Engine exhaust is collected by a system of headers. The left side cylinder exhaust is routed through the left turbocharger. The right side cylinder exhaust is routed through the right turbocharger. Both the left and right side headers are connected to a single wastegate on the left side that exhausts into the left tailpipe. The left and right turbochargers exhaust out of the cowling through independent tailpipes. The left tailpipe also provides a vent for the crankcase oil breather system.

Inspections for cracking, burn through, etc. is required during each maintenance activity and inspection of the tailpipes is recommended before each flight. Particular attention should be paid to any crack, burn through, or loose tailpipe clamps that may allow exhaust to impinge on the firewall. Do not attempt flight if the exhaust system is compromised.

FUEL INJECTION

The fuel injection system is of the multi-nozzle, continuous flow type which controls fuel flow to match engine requirements. Any change in air throttle position, engine speed or a combination of these causes changes in fuel pressure in direct relation to engine requirements. A manual mixture control is provided for precise leaning at any altitude and power setting. A fuel flow system is installed for digital read out of fuel flow in gallons per hour. However, fuel flow is NOT to be used as reference for manual leaning. Use the TIT gauge for this purpose.

The continuous-flow system permits the use of a typical rotary vane pump with integral relief valve. With this system there is no need for an intricate mechanism for timing fuel injection to the engine. The fuel injector pump is equipped with a separator where vapor is separated by a swirling augments system from the liquid fuel and returned to the tank selected. The fuel injector pump forces liquid fuel into the metering unit assembly.

The fuel metering unit/air throttle controls the amount of intake air admitted into the intake manifold and meters the proportionate amount of fuel to the fuel manifold valve. The assembly has three control units, one for air, in the air throttle assembly, and two for the fuel control unit.

The manifold valve receives fuel from the metering unit. When fuel pressure reaches approximately 3.5 PSI, a check valve opens and admits fuel to six ports in the manifold valve (one port for each fuel nozzle line). The manifold valve also serves to provide a clean cut off of fuel to the cylinder when engine is shut down.

The injector nozzle lines connect the manifold valve to the six fuel injector nozzles.

The injector nozzles (one per cylinder) are "air bleed" type fuel nozzles which spray fuel directly into the intake port of the cylinder. When engine is running, flow through the nozzle is continuous and will enter the cylinder combustion chamber when the intake valve opens.

Since the size of the fuel nozzles are fixed, the amount of fuel flowing through them is determined by the pressure applied. For this reason, fuel flow may be accurately determined by measuring fuel pressure at the manifold valve.

ENGINE COOLING AIR

Ram air enters the forward part of upper cowl and flows through the cylinders, intercoolers, oil cooler, and alternators using several baffles to control air direction. Hot air, off the engine, exits the cowl thru lower cowl openings, located on either side of engine lower cowl, immediately forward of the firewall.



ENGINE STARTING SYSTEM

Engine starting is provided by a 24 volt starter. The starter engages the drive shaft with a spring clutch. Avoid manually turning the propeller backwards as it may damage the clutch. A starter engaged warning annunciation (START POWER) is incorporated in the annunciator panel.

Ignition is provided by an impulse coupled magneto. The engine firing order is 1-6-3-2-5-4. The ignition harnesses are connected to the magnetos so the right magneto fires the upper plugs on the right side and lower plugs on the left. The left magneto fires the upper plugs on the left and the lower plugs on the right.

ACCESSORIES

EXHAUST GAS TEMPERATURE PROBE

The exhaust gas temperature (EGT) probe measures exhaust gas temperature as it exits the exhaust valves into the exhaust manifold. The EGT probe varies electrical current (milliamps), based on exhaust gas temperature, and displays this data on the Garmin GDU 10(XX) Multi-Function Display.

TURBINE INLET TEMPERATURE (TIT)

The TIT (Turbine Inlet Temperature) indicator displays the temperature at the turbine inlet in degrees Fahrenheit. A green bar indicates "Normal" operating range of 1000 to 1750 degrees Fahrenheit. A red "Warning" bar indicates 1750 degrees Fahrenheit. The TIT gauge is used as the primary source to lean fuel mixture.

PROPELLER

HARTZELL THREE BLADE PHC- J3YF- 1RF/F7498 or PHC- J3YF- 1RF/F7498(B)

The (B) denotes a booted prop (for TKS)

The propeller is a three- blade, 76 inch (193 cm.) diameter, constant speed unit that features aluminum blades in an aluminum hub. The spinner is fabricated from aluminum alloy. A more detailed description is found in Hartzell Manual 115N (Propeller Owner's Manual).

Centrifugal twisting moment acting on the blades moves the blades to a low blade angle (low pitch) to increase RPM. Since the centrifugal twisting moment is only present when the propeller is rotating, a mechanical spring is installed within the propeller to assist movement of the blades to a lower pitch position as RPM decays, and to reduce the propeller pitch to the low pitch stop when the propeller is static. With the blades at low pitch, the load on the starter when starting the engine is reduced significantly.

Oil pressure opposes the spring and centrifugal twisting moment to move the blades to a high blade angle (high pitch), reducing engine RPM. If oil pressure is lost at any time, the propeller will move to low pitch. This occurs because the spring and blade centrifugal twisting moment are no longer opposed by hydraulic oil pressure. The propeller will then reduce blade pitch to the low pitch stop.

In cruise, always use the power setting charts provided in [SECTION V](#).



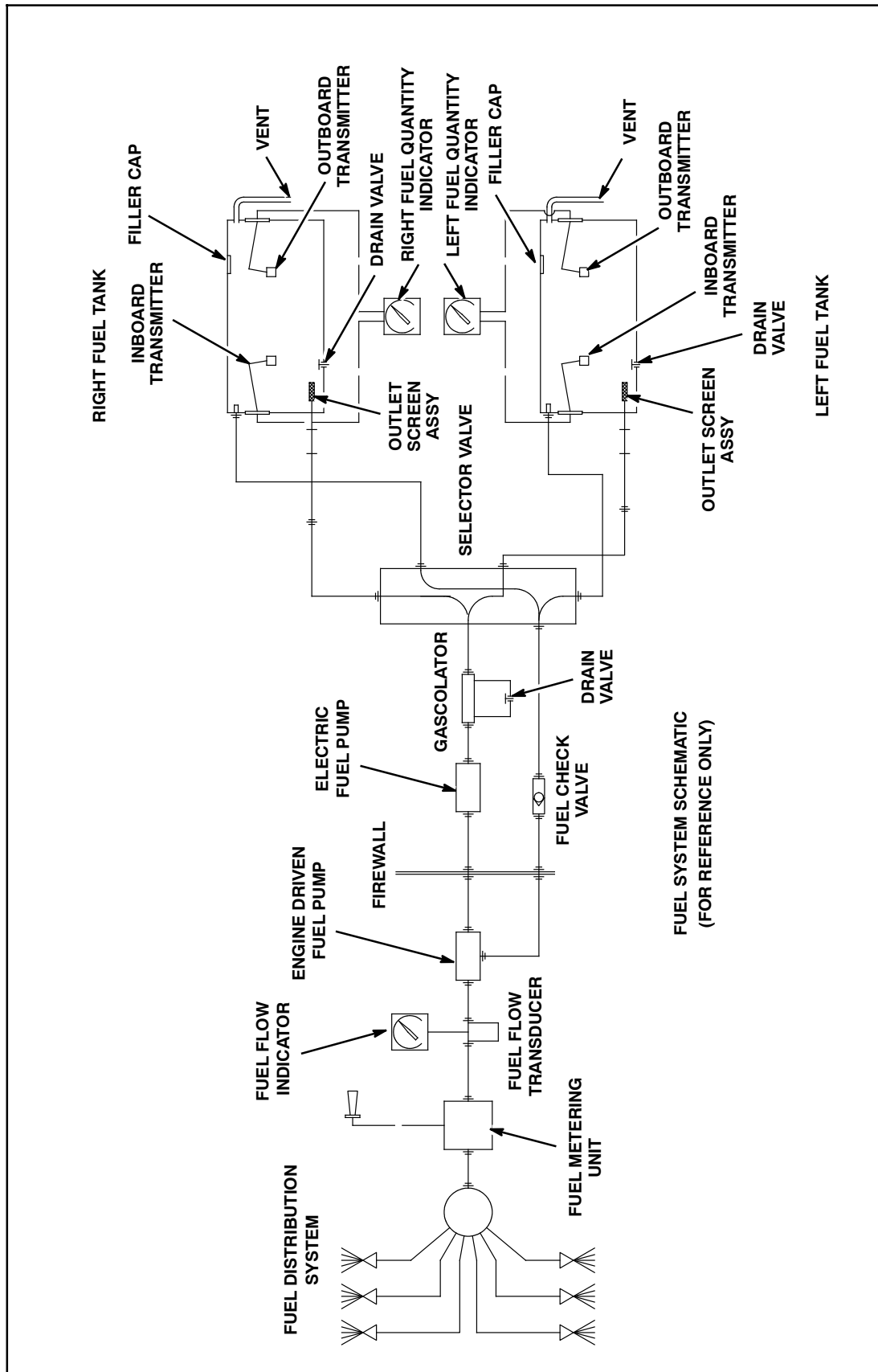

FIGURE 7-7 FUEL SYSTEM SCHEMATIC



FUEL SYSTEM

Fuel is carried in two integrally sealed sections of the forward, inboard area of wing. Total usable fuel capacity is 89 U.S. gallons (336.9 liters). There are sump drains at the lowest point in each tank for taking fuel samples to check for sediment contamination or condensed water accumulation.

The recessed three position handle aft of the console, on the floor, allows pilot to set selector valve to LEFT tank, RIGHT tank or OFF position.

The gascolator, located at right of selector valve, in the floorboard, is for draining condensed water and sediment from lowest point in fuel system before first flight of the day and after each refueling. The gascolator sump can be used to drain the selected fuel tank.

Fuel is delivered, by the engine driven pump, to a throttle body fuel injector where pressure is regulated and the correct volume of fuel is metered to each cylinder of the engine. Fuel not needed by the engine is returned to the tank from which it is drawn.

The HIGH BOOST pump switch operates the fuel boost pump on high power. The high boost setting is capable of operating the engine in case of engine driven fuel pump failure or severe fuel filter blockage. High Boost may be used on the ground as an engine starting aid. Continuous operation should be avoided except in an emergency. Never run the boost pump without fuel in the system. Refer to SECTIONS III and IV for proper use of the HIGH BOOST setting.

-CAUTION-

Pushing HIGH BOOST pump switch ON when engine driven pump is operating properly will cause engine to quit due to excessive rich fuel mixture.

The BOOST PUMP (Low Boost) switch operates the fuel boost pump on low power to provide a means of suppressing fuel vapor from fuel system during hot day and high altitude conditions. Low boost may also be used as an engine starting aid. Continuous operation of the low boost is permitted. Never run the boost pump without fuel in the system. Refer to [SECTIONS III](#) and [IV](#) for proper use of the BOOST PUMP setting

-CAUTION-

Pushing LOW BOOST pump switch ON when engine is operating properly at idle conditions will cause engine to run rough or quit due to excessive rich fuel mixture. For this reason LOW BOOST should normally be turned off except where prescribed in the normal operating procedures.

Two electric fuel- level transmitters, working in series, in each wing tank operate the appropriate, left or right, fuel quantity gauges. The master switch actuates the fuel quantity indicator system to depict an indication of fuel remaining in each tank. Vents in each fuel tank allow for overflow and pressure equalization.

The optional, visual fuel quantity indicators, in the top of each wing, are to be used for PARTIAL FUEL LOADING only and NOT for preflight inspection purpose. The Fuel Flow indicating system indicates the volume of fuel being used, total fuel used or fuel remaining or time remaining (refer to GARMIN User Manual).

ELECTRICAL SYSTEM

ALTERNATOR & BATTERY

The M20V has a 28 Volt DC electrical system, powered by a 100- amp alternator which is mounted on the front of the engine. It is driven by the engine crankshaft through a shear mechanism and charges the main batteries. The alternator is the primary source of aircraft power and is connected to the aircraft electrical system at the main bus. In the event of an alternator failure, a 20



Amp standby alternator, actuated by the pilot using a manual switch in the cockpit labeled EMER BUS, powers Essential systems as presented on the fascia of the Circuit Breaker Panel. If the Primary and Standby charging systems fail, the ship's battery(s) provide the system with electrical power.

The M20V has 2 separate 11 ampere/hour batteries, which are mounted in the tail cone. Either battery can be selected to power the electrical bus using the BATT 1/BATT 2 select rocker switch mounted on the LH side of the Pilot's Flight Panel. Only one battery will power the bus at any one time. The unselected battery will be trickle charged by the ship's alternator when the engine is running and the ammeter shows a positive charge condition. The selected battery is connected to the aircraft bus by the BATT MASTER rocker switch located on the LH side of the Pilot's Flight Panel. The aircraft has an External Power receptacle located on the left side of the tailcone, aft of the tailcone access panel. When external power is connected to this receptacle, either or both batteries may be charged. The External Power receptacle can also be used for maintenance activities, or to start the engine.

In the event of an alternator failure, selecting EMER BUS will:

- Power the standby alternator.
- Shed unessential loads and power Essential systems consisting of:
 - G1000 system, which is comprised of the PFD/MFD, AHRS, ADC, Com1, Nav1, GPS1, transponder, audio panel, and Engine Instruments;
 - An independent, standby attitude indicator (artificial horizon);
 - Aux. Overhead Equipment, Aux Panel Equipment, and Ice Protection

Activating the EMER BUS switch bypasses the master switch and electrically feeds the standby attitude indicator and all standby lighting using both main batteries in the event that the Standby Alternator also fails.

-NOTE-

In flight, NEVER deselect the BATT MASTER switch unless the EMER BUS switch is energized.

ESSENTIAL BUS

The Essential bus is tied directly to the main aircraft battery via the non-essential bus. When the master switch is turned on, power is immediately supplied to the Essential and non-Essential busses. The Essential bus provides power to the G1000 equipment and to the backup instruments. When the Emergency Bus switch is activated by the pilot, the standby alternator is brought online and two relays close to power the essential bus via a secondary path. The selected main battery (two main batteries are available) remains online.

NON - ESSENTIAL BUS

The non-essential bus powers the autopilot, the Stormscope, and GIA #2. This bus is load shed manually by the pilot by pulling the BATT circuit breaker when the standby alternator and emergency bus switch are activated.

EQUIPMENT LOCATION

The G1000 ADC and GEA LRU's are located behind the PFD and MFD, which may be removed using a hexagonal tool. The magnetometer is located in the right wing outboard of the landing light. The AHRS, and remaining LRU's are located in the forward section of the tailcone near the main batteries.



SCHEMATIC (See FIGURE 7-8)

The voltage regulator adjusts alternator output to current load while maintaining a constant voltage level. It also prevents Overvoltage and Field Short conditions from damaging the electrical system. A voltage warning annunciation illuminates steadily when voltage limits are exceeded (i.e. voltage spikes) and flashes when the voltage is low.

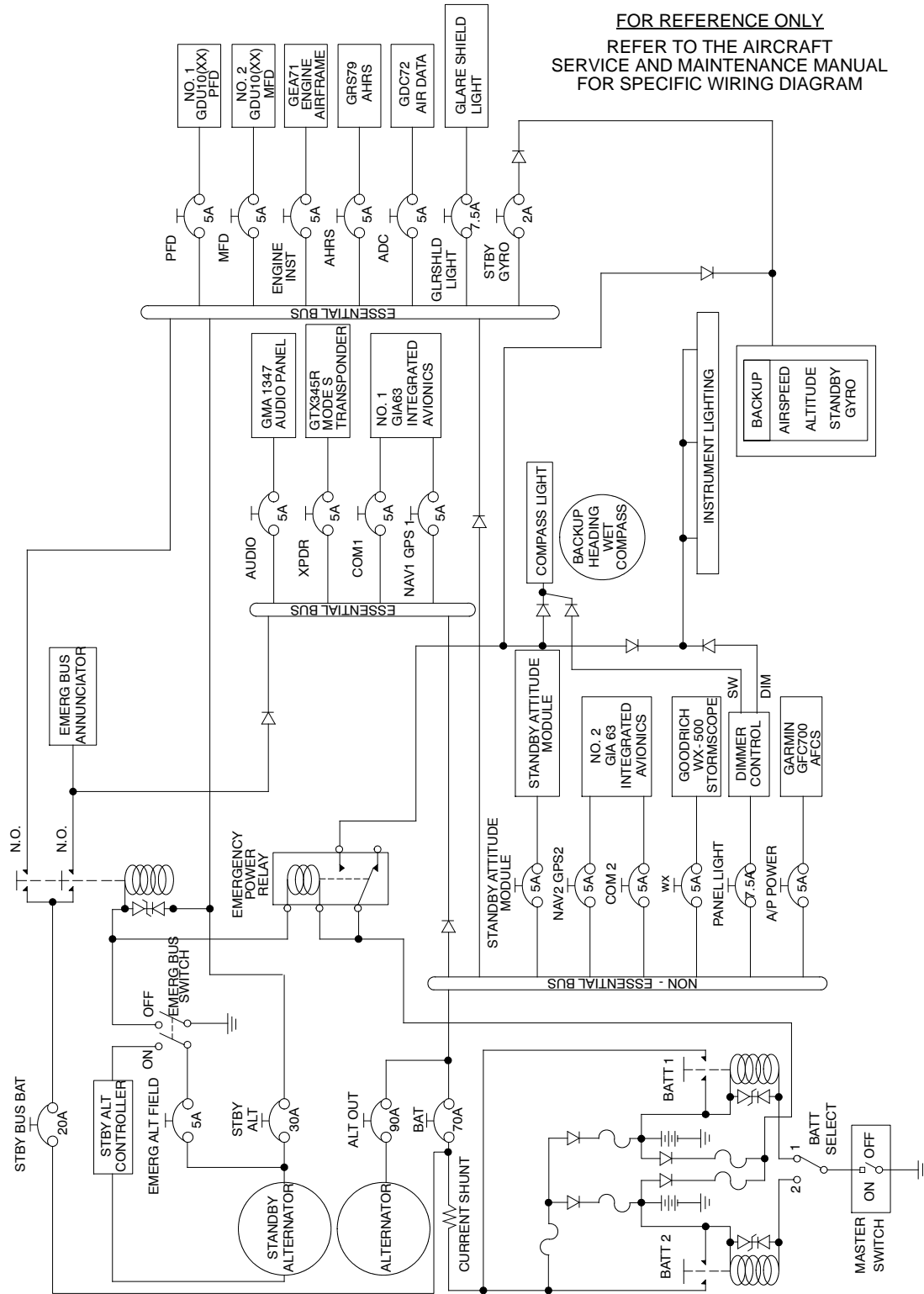

Figure 7-8 M20V POWER SUMMARY - GENERIC SYSTEM SHOWN



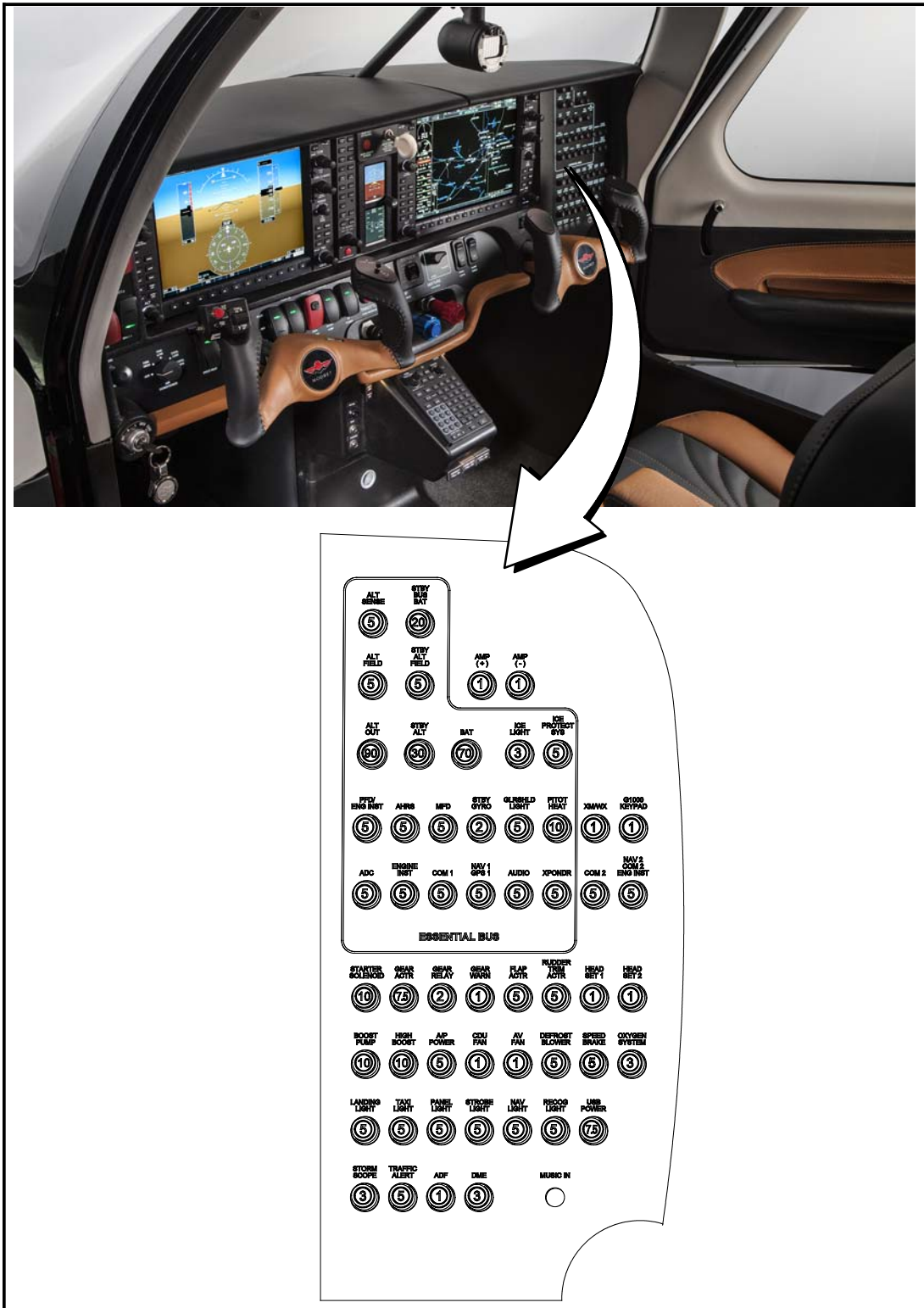

FIGURE 7-9 CIRCUIT BREAKER PANEL (TYPICAL)

**CIRCUIT BREAKER PANEL (See FIGURES 7-9)
(Illustration depicts typical C/B panel; may vary from your aircraft)**

The circuit breaker panel is located on the right side of the instrument panel. Each breaker is clearly marked to show which circuit it protects. Also, circuit provisions are made to handle the addition of (optional) communications and navigation equipment.



Push-pull circuit breakers automatically break the electrical current flow if the system or unit receives current overload to prevent damage to electrical wiring. Figure 7-9 illustrates a typical main circuit breaker panel with its push-pull circuit breakers.

The alternator's push-pull circuit breaker, on the main breaker panel, furnish an emergency overload break between the alternators and the power bus. Since the alternator is incapable of output in excess of circuit breaker capacity, a tripped breaker normally indicates a fault within the alternator.

-WARNING-

NEVER fly the aircraft with a severely discharged battery, even if you do not plan to use it. Selection of a severely discharged battery in flight can cause a current "in-rush" from the alternator, and may damage on-board systems.

The alternator field has a push-pull circuit breaker to furnish an emergency break in the alternator field excitation circuit in the event of alternator or voltage regulator malfunction. If regulator output voltage exceeds limits, the warning annunciation illuminates steadily and the alternator field circuit breaker trips.

Resetting the alternator field circuit breaker should reset the alternator. If the circuit breaker will not reset, continue flight with minimum electrical load. The flight will be continued using only battery power, caution is advised to not drain both batteries if electrical power will be required before you are able to land. Land when practical to correct the malfunction.

-NOTE-

The circuit breakers installed in the panel may vary depending on installed equipment.

ACCESSORIES

Standard electrical accessories include the starter, the electric fuel pump, and the stall warning horn. Electrical accessories include the navigation lights, anti-collision strobe lights, instrument panel lighting, and cabin courtesy lights. Make sure the lighting and Emergency Bus switch, as well as the SAM circuit breaker are de-energized when leaving the aircraft. Leaving these systems energized for an extended period of time could cause depletion of the battery.

1 dome and 4 reading lights, mounted in the overhead panel and glareshield lights, mounted below edge of glareshield provide instrument and cockpit lighting for night flying. A wing tip position light system consists of 2 lights on each wingtip and is operated by a rocker type switch mounted in the overhead switch panel. Landing and taxi lights are mounted on the wing leading edges on both wings.

Wing tip and tail mounted Strobe lights are controlled by a rocker type switch mounted in the overhead switch panel.

The M20V electrical system is divided into two power buses. A simplified schematic of the electrical system is shown in the diagram which follows.

ANNUNCIATIONS AND ALERTS

The landing gear, speed brakes, alternate air, prop de-ice, pitot heat, alternator fail, start power, emergency buss, door open, Low/High boost pump annunciations are grouped in the GDU10(XX) PFD panel.

LIGHTING SYSTEM

INSTRUMENT & PLACARD LIGHTS

All placards are floodlighted by lights from the glareshield. There are two momentary switches on the right hand radio panel, below the MFD. The right switch regulates intensity of the placard lighting. The left switch provides avionics and instrument lighting. Selecting the switches up or down increases or decreases light intensity.



MAP LIGHT

Map lights are installed on the bottom of the pilot and co-pilot's wheel. The intensity of the map light may be adjusted with the MAP LITE knob located (while facing the wheel) on the right aft side of the pilot's and co-pilot's control wheel.

CABIN LIGHTING

Overhead lights illuminate the cabin, 1 dome and 4 reading lights. All passenger reading lights are controlled by a main switch located on the instrument panel below the PFD. With Reading Light Switch UP position, only the Pilot reading light is activated. With Reading Light Switch in Down position, ALL reading lights are activated. Passenger switches are located on the overhead panel.

A momentary light switch has been installed on both cabin and baggage doors. When one of the cabin or baggage doors are opened, the baggage light will illuminate for approximately 1.5 minutes and then distinguish until door has been shut and reopened again.

-CAUTION-

The Dome Light rocker switch is connected directly to the battery. Leaving the switch on indefinitely when the engine is shutdown will run down the batteries.

EXTERIOR LIGHTING

Conventional navigation and high intensity strobe lights are installed on the wing tips and on the rudder trailing edge (strobe light only). Landing and Taxi lights are installed in the right and left wing leading edge. A switch is used to control both the left and right taxi and landing lights. All exterior light switches are located on overhead panel just behind top of windshield.

The high intensity wing tip and tail strobe lights are required for night operation but should be turned OFF when taxiing near other aircraft or flying in fog or clouds. The conventional position lights must be used for all night operations.



CABIN ENVIRONMENT

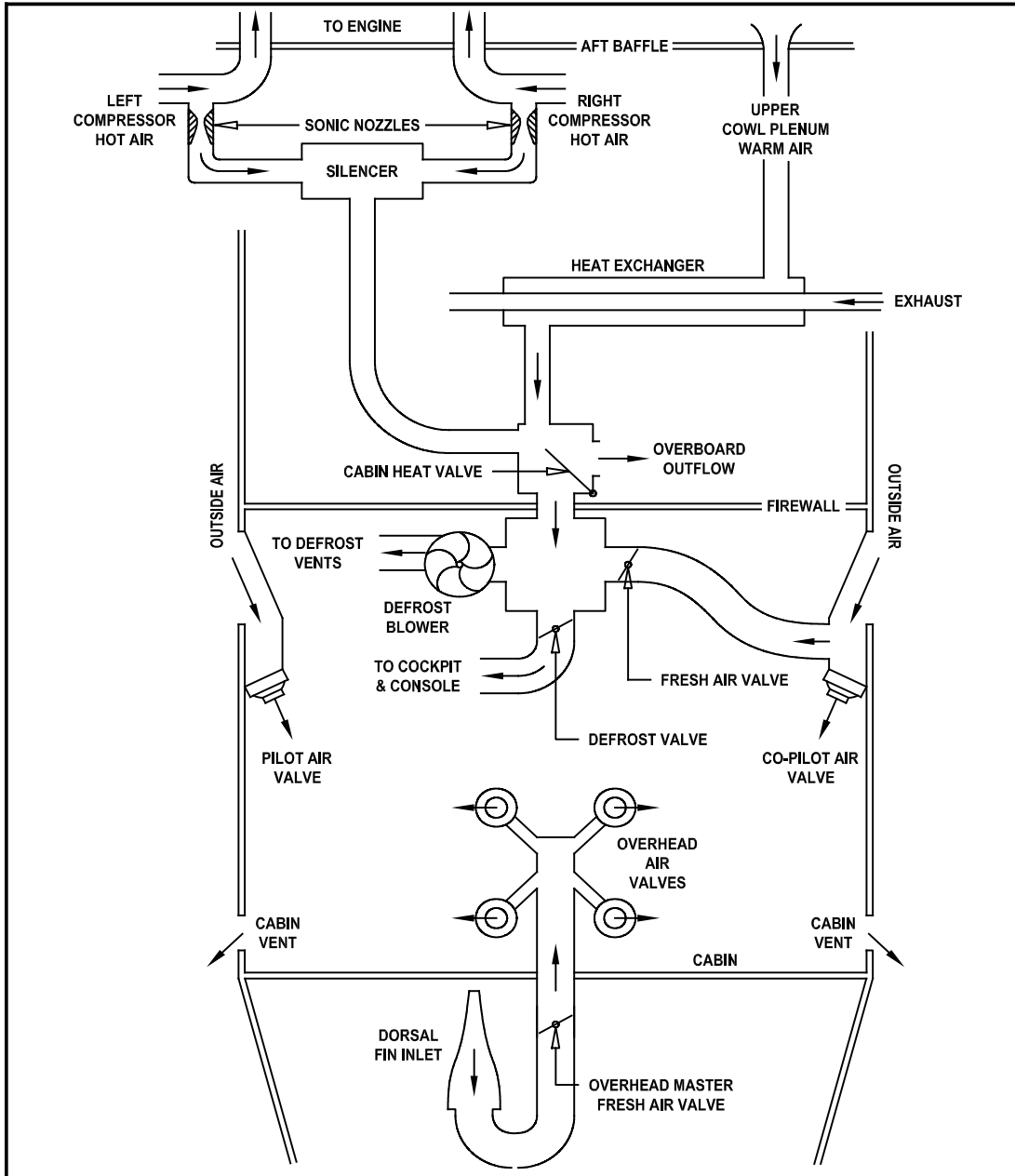

FIGURE 7- 10 CABIN AIR FLOW CABIN ENVIRONMENT

HEATING & VENTILATION SYSTEMS

Multiple controls are available to provide fresh air and/or heated fresh air according to individual preferences.

PILOT/CO- PILOT AIR VALVE - One adjustable swivel head valve is provided for each cockpit seat on the cabin walls at knee height just forward of the front seats. These valves are supplied directly by outside ram air. Twist vent to adjust flow. Tilt vent to direct flow.

CABIN VENT - The CABIN VENT handle on the center console opens a valve that will mix fresh outside air with the cabin heat or defrost system. Pull CABIN VENT knob to open. When cabin heat is on intermediate settings between full open and full closed provide continuously variable mixing ratios. Cold and hot air mixing may be used to control the total cabin heat output.



CABIN HEAT - Sonic nozzles extract high temperature bleed air immediately downstream from the turbo compressor. A silencer quiets the bleed air flow. The nozzles are most effective at high altitude and higher power settings because they rely on the compressor pressure ratio & speed to create hot air flow.

A second source of hot air comes from a fresh (ram) air port on the aft engine baffle. This air is routed through a heat exchanger located on the exhaust system. This source is most effective at lower altitudes (warmer ambient temperature), higher speeds, and a wide range of cruise power settings. Heat from this source is proportional to the turbo inlet temperature (TIT).

Both the hot bleed air and hot ram air are mixed together at the cabin heat valve. With the heat valve closed unused hot air is exhausted into the cowling. Pulling the CABIN HEAT handle on the center console AFT opens the cabin heat valve and closes the overboard outflow vent to provide heated air to the cabin. Intermediate settings will provide intermediate amounts of cabin heat flow and overboard outflow. If exhaust or oil fumes are detected in the cockpit immediately shut the CABIN HEAT valve. Oil fumes may be a sign of impending turbo bearing failure or other oil leakage into the induction system and should be investigated post flight.

OVER HEAD VENTILATION - Cabin overhead ventilating system works independently of cabin heating and ventilating system. Fresh air enters a duct on dorsal fin and is controlled by individual outlets above and between each seat. A master air vent control is located between the pilots & co-pilots seat on the overhead panel. Rotating this control left or right will regulate the total air flow available to all four overhead vents.

DEFROST - The windshield defrost system takes air from the cabin air distribution system and distributes this over the windshield interior surface any time the CABIN HEAT and/or CABIN VENT valves are opened. Pulling the DEFROST control full AFT decreases flow to the cabin, turns the defroster blower ON and forces maximum air to flow through the defrost ducts.

PITOT PRESSURE & STATIC SYSTEM

A pitot tube, mounted on lower surface of the left wing, picks up ram air for air speed indication. Two static ports, one on each side of the tailcone, supply static air pressure for the altimeter, the airspeed indicator, and vertical speed indicator.

A pitot heater prevents pitot tube icing when flying in moisture-laden air. A pitot system drain valve is located on the forward bottom skin of the left wing to fuselage fillet. A static system drain valve is located on fuselage bottom skin below the left side, tailcone access door and is used to drain moisture that might collect in static system lines. Excessive moisture in the system can affect instrument readings.

An alternate static pressure source valve handle is installed in the instrument panel below the pilot's control wheel shaft. Alternate static air pressure is sensed from within the cabin and will affect flight instrument readings. Correction charts in [SECTION V](#) depict the difference between indicated and calibrated instrument readings for both primary and alternate static systems assuming zero instrument error. These corrections are required to determine true airspeed. The true airspeed indicated on the MFD and the backup airspeed indicator doesn't include static error corrections.

STALL WARNING SYSTEM

The electrical stall warning system uses a vane-actuated switch, installed in left wing leading edge, to energize stall warning horn located in the cabin. The stall warning switch is adjusted to provide aural warning (VOICE ALERT) at 5 to 10 KIAS before actual stall is reached and will remain on until aircraft flight attitude is changed toward a non-stalled condition.

-NOTE-

Do not attempt to adjust prestall warning speed by bending the vane. This part has been heat treated and cannot be bent without damaging or breaking the vane.



OXYGEN SYSTEM

If Oxygen is Required or Preferred, Refer to Supplemental Information in [Section IX](#)

VACUUM SYSTEM

The M20V aircraft is all electric. There is no Vacuum System in the standard aircraft.

EMERGENCY LOCATOR TRANSMITTER

The ARTEX ME-406 Emergency Locator Transmitter (ELT) is located in the tailcone and is accessible from the battery access door on the right side of the tailcone. The emergency locator transmitter meets the requirements of FAR 91.52 and is automatically activated by a longitudinal force of 4.5 feet/second \pm 0.5 feet/second (2.3g). The ELT transmits a distress signal on both 121.5 MHz and 406.0 MHz. The 121.5 MHz signal will operate for 24 hours and then automatically shut down. The 406.0 MHz signal will continue to operate until the batteries are exhausted, which is at least 50 hours. The unit operates on a self-contained battery. The battery should be checked at each annual inspection. The battery has a useful life of six years. However, to comply with FAA regulations it must be replaced after two years of shelf life. The battery should also be replaced if the transmitter has been used in an emergency situation or if accumulated test time exceeds one hour. The battery replacement date is marked on the transmitter label.

On the unit itself is a two-position selector switch placarded "ARM" and "ON". The "ARM" position is provided to set the unit to the automatic position so that it will transmit only after impact and will continue to transmit until battery is drained to depletion or until the switch is manually reset. "ARM" position is selected when the transmitter is installed at the factory and switch should remain in that position whenever unit is installed in the airplane. The "ON" position is provided so unit can be used as a portable transmitter or in the event the automatic feature was not triggered by impact or to periodically test the function of the transmitter. Reset the unit by selecting the "ON" position for approximately one second and returning the switch to the "ARM" position.

ELT REMOTE SWITCH OPERATION

A pilot's remote ELT switch is located just below the bottom right corner of the co-pilot MFD. The remote ELT switch allows the transmitter to be controlled from inside the cabin. ELT is activated when the ON button is pushed. The unit can be reset by selecting "ON" position for approximately one second and returning the switch to the "ARM" position. Both the remote switch on the control panel and the local switch on the unit must be in "ARM" position for the unit to be armed.

-NOTE-

If for any reason a test transmission is necessary, the operator must first obtain permission from a local FAA or FCC representative (or other applicable Authority) or in accordance with current regulations. Test transmission should be kept to a minimal duration. Testing of ELT should be conducted only during the first five (5) minutes after any hour and no longer than three (3) audible sweeps.

The ELT should be checked during the ground check to make certain the unit has not been accidentally activated. Check by tuning a radio receiver to 121.5 MHz. If there is an oscillating/warbling sound, the locator may have been activated and should be turned off immediately. Reset to "ARM" position and check again to insure against outside interference.



BLANK



TABLE OF CONTENTS

TITLE	SECTION
INTRODUCTION	8-3
GROUND HANDLING	8-4
TOWING	8-4
TIEDOWN	8-4
JACKING	8-4
SERVICING	8-5
REFUELING	8-5
FUEL ADDITIVES	8-5
ENGINE LUBRICATION	8-6
INDUCTION AIR FILTER	8-6
GEAR AND TIRES	8-8
BATTERIES	8-8
HYDRAULIC BRAKE RESERVOIR SYSTEM	8-9
OXYGEN SYSTEM	8-9
MAINTENANCE	8-9
ENGINE PERFORMANCE CHECKS	8-9
PROPELLER CARE	8-9
EXTERIOR CARE	8-9
INTERIOR CARE	8-10
AIRPLANE FILE	8-10



BLANK



INTRODUCTION

This section contains factory recommended procedures for proper ground handling, routine care and servicing of your Mooney.

It is required that all aircraft undergo a complete inspection (ANNUAL) each twelve calendar months. In addition to the required ANNUAL inspection, aircraft operated commercially (for hire) should have a complete inspection every 100 hours of operation. All inspections must be performed by a designated representative of the FAA or the Aviation Authority of the country in which the aircraft is licensed.

The FAA may require other inspections by the issuance of Airworthiness Directives applicable to the airplane, engine, propeller and other components. It is the responsibility of the owner/operator to ensure compliance with all applicable Airworthiness Directives and recommended "MANDATORY" Mooney Service Bulletins/Instructions. When inspections are repetitive the owner/operator should take appropriate steps to prevent inadvertent non-compliance.

Scheduling of ALL maintenance is the responsibility of the aircraft operator. A general knowledge of the aircraft is necessary to perform day-to-day service procedures and to determine when non-routine or unusual service or shop maintenance is needed.

Service information in this section of the manual is limited to service procedures which the operator will normally perform or supervise. Reference should be made to CFR Part 43 and 91 for information regarding preventive maintenance which may be performed by a U.S. licensed pilot.

It is wise to follow a planned schedule of lubrication and preventive maintenance based on climatic and flying conditions encountered in your locality.

Keep in touch with your Authorized Mooney Service Center and take advantage of his knowledge and experience. He knows your airplane and how to maintain it. Should an extraordinary or difficult problem arise concerning the repair or upkeep of your Mooney, consult the:

Product Support Department
Mooney International Corporation
165 Al Mooney Road, Kerrville, TX. 78028
Telephone: (830) 896-6000 or (800) 331-3880
Email: technicalsupport@mooney.com or support@mooney.com

All correspondence regarding your airplane should include the aircraft **MODEL** and **SERIAL NUMBER**. These numbers can be found on an identification plate located on the lower aft portion of the left side of the tailcone. The aircraft Model and Serial Number must also be used when consulting either the Mooney Service & Maintenance Manual or Illustrated Parts Catalog.

Service & Maintenance Manuals and **Illustrated Parts Catalogs** for your airframe and systems (excluding Avionics & Navigation) may be obtained from your Mooney Service Center. **Service Bulletins and Service Instructions** are available for download and printing from the Mooney International Corporation website, www.mooney.com.

Avionics and Navigation Systems information should be obtained from the applicable manufacturers.

Engine information should be obtained from:
Continental Motors, Inc.
2039 Broad Street
Mobile, AL 36615, USA
Telephone, (800) 718-3411.



GROUND HANDLING

TOWING

For maneuvering the aircraft in close quarters, in the hangar, or on the ramp, use the manual tow bar furnished with the aircraft loose equipment. The tow bar attaches to the nose gear crossbar. One man can move the aircraft providing the ground surface is relatively smooth and the tires are properly inflated.

When no tow bar is available, or when assistance in moving the aircraft is required, push by hand:

1. On wing leading edges
and
2. On inboard portion of propeller blades adjacent to propeller hub.

Towing by tractor or other powered equipment is NOT RECOMMENDED.

-CAUTION-

Exercise care not to turn the nose wheel past its normal swivel angle of 11° Left or 13° Right of center. Exceeding the turn limits shown on the turn indicator may cause structural damage.

TIE DOWN

As a precaution against wind damage, always tie down the aircraft when parked outside. Removable wing tie down eye-bolts, supplied with the loose equipment, screw into wing receptacles marked HOIST POINT just outboard of each main gear.

Replace these eye bolts with jack point fixtures when it is necessary to lift the aircraft with jacks. The tail tie down point is part of the tail skid.

To Tie Down Aircraft:

1. Park the airplane facing the wind.
2. Fasten the co-pilot seat belt through the flight control wheel. Pull seat belt snug so flight controls are immobilized.
3. Fasten strong ground-anchored chain or rope to the installed wing tie down eye bolt, and place wheel chocks fore and aft of each wheel.
4. Fasten a strong ground-anchored chain or rope through the tail skid.

JACKING

When it is necessary to raise the aircraft off the ground:

1. Install jack points in tie down mounting holes outboard of each main gear.
2. Use standard aircraft jacks at both wing hoist points (wing tie down eyebolt receptacles) outboard of the main gears. While holding jack point in place, raise jack to firmly contact jack point.
3. Place a jack under front jack point (Sta. - 5.51) to lift nose wheel.
4. Raise aircraft, keeping wings as nearly level as possible.
5. Secure safety locks on each jack.



-CAUTION-

Do not raise the aircraft on jacks out of doors when wind velocity is over 8 KTS. When lowering aircraft on jacks, bleed off pressure on all jacks simultaneously and evenly to keep aircraft level as it is lowered.

-NOTE-

Individual wheels may be raised without raising entire aircraft. Wheels not being raised should be chocked fore and aft.

SERVICING

REFUELING

Integrally sealed tanks, in forward, inboard sections of wing (LH & RH), carry the standard fuel quantity. With aircraft positioned on level ground, service each fuel tank after flight with 100 octane or 100LL aviation grade gasoline. The fuel tank is considered full when fuel completely covers bottom of standpipe.

The optional, fuel quantity sight indicators on top of each wing tank should be used as a reference for partial refueling only. These gauges will not indicate the tank's total capacity above 30 gallons of fuel.

Before filling fuel tanks, when planning a maximum weight flight configuration, consult the [Weight & Balance Record \(SECTION VI\)](#) for loading data.

-CAUTION-

Never use aviation fuel of a lower grade than 100 octane or 100LL avgas.

Fuel samples from the sump drain of each tank should always be taken before the first flight of the day to check for water, sediment or other contamination. It is recommended that fuel samples be taken prior to each flight. Fuel samples taken immediately after refueling may not show water or sediment due to mixing action of refueling process.

-WARNING-

Allow five minutes after refueling for water and sediment to settle in tank and fuel drain valve before taking fuel samples or draining gascolator.

Tank sump drains are near each wing root, forward of the wheel wells. A small plastic cup is supplied as loose equipment for obtaining fuel samples. To collect a fuel sample, insert cup actuator prong into sump drain receptacle; push upward to open valve momentarily and drain fuel into cup. If water is in fuel, a distinct line separating water from gasoline will be seen through transparent cup wall. Water, being heavier, will settle to bottom of cup, while colored fuel will remain on top. **Continue taking fuel samples until all water is purged from tank.** Aircraft should be in a level position to prevent the possibility of any contamination not being at sump drain area.

The fuel system gascolator is on the cabin floor, forward of co-pilot's seat. To flush system and lines leading from wing tanks to selector valve, turn selector handle to the left tank position and pull fuel drain valve for about five seconds. Repeat procedure for right tank. Be sure fuel drain valve is returned to closed position and drain valve is not leaking.

-NOTE-

Use recommended engine break-in procedures as published by engine manufacturer.

FUEL ADDITIVES

-CAUTION-

Ethylene glycol monomethyl ether (EGME) or other additives are not recommended due to potential deteriorating effects within the fuel system.



Under certain conditions of temperature and humidity, water can be present in fuel in sufficient quantities to create ice formations within the fuel system. To prevent this, add Anhydrous ISO-PROPYL Alcohol to the fuel supply in quantities not to exceed 3% of total fuel volume per tank.

ENGINE LUBRICATION

Operate and service new engine within limitations given in [SECTION II](#) and per Continental Mo-tors, Inc. Maintenance and Operators Manual.

Before every flight, check engine oil level and replenish as necessary.

The oil filler cap access door is located in top cowling. Any lubricating oil must conform with Continental Motors, Inc. Specification MHS24 to be acceptable for use in engine. See Continental Motors, Inc. Maintenance and Operators Manual for specifically approved products.

During the engine break-in period, Nondispersant mineral oil conforming to SAE 51 966 shall be used. However, if the engine is flown less than once a week, a straight mineral oil with corrosion preventative MIL-C-6529 for the first 25 hours is recommended. After the first 25 hours of the airplane’s time in service, the oil and oil filter must be changed and a new supply of Continental Motors, Inc. specification MHS-24 (latest revision) ashless dispersant oil must be used. At 50 hours of time in service, the oil and oil filter shall be changed. Discard the old filter and replace with new. Check discarded oil for evidence of metal particles. Thereafter, the oil and oil filter must be changed at every 50 hours of time in service.

At the first oil change, the engine and related accessories including the magnetos, starter, alternator, engine driven fuel and oil pumps, oil cooler, and propeller governor, should be inspected for oil leaks and security.

Your Authorized Mooney Service Center will change engine oil in addition to performing all other service and inspection procedures needed when you bring your airplane in for its 50-hour; 100-hour, or annual inspections.

-CAUTION-
Excessive oil sludge buildup indicates that the oil system needs servicing at less than 50-hour intervals.

When changing or adding oil, the following grades of oil are recommended:

Oil Grades Recommended for Various Average Air Temperature Ranges	
Below 40° F (4° C)	SAE 30, 10W30, 15W50 or 20W50 *
Above 40° F (4° C)	SAE 50, 15W50 or 20W50 *
Total Oil Capacity	8 Qts. (7.57 liters)
Oil Filter	Full Flow

-NOTE-

The first time the airplane is filled with oil, additional oil is required for the filter, oil cooler and propeller dome. This oil is not drainable on subsequent oil changes. Added oil is mixed with a few quarts of older oil in the system.

* Refer to the latest edition of Continental Motors, Inc. Maintenance and Operators Manual for approved brands of oil.

All Authorized Mooney Service Center’s stock approved brands of lubricating oil and all consumable materials necessary to service your airplane. For a listing of Authorized Mooney Service Centers, visit www.mooney.com

INDUCTION AIR FILTER

The importance of keeping the induction air filter clean cannot be over-emphasized. A clean filter promotes fuel economy and longer engine life.



Challenger Aviation Products

Re-charging instructions must be followed carefully for maximum air filter life. Air filter must be recharged every 100 hours or 12 months or sooner if operated in extreme dusty conditions. Air filter assembly must be replaced after 25 cleanings or sooner if any deterioration or damage is found during pre-flight, post flight or any other aircraft inspections.

To clean the Challenger Aviation Products filter:

1. Remove engine cowling.
2. Remove the air filter assembly from the aircraft air box. DO NOT REMOVE filter element from inside its frame. Remove the old sealing gasket from filter assembly with frame.
3. Begin re-charging air filter by “gently” tapping the filter assembly on a hard surface to remove any loose dust that will easily fall off the filter. Visually inspect the filter for any damage, cracks, broken wires or missing fibers. If any of those conditions are visible, the filter assembly must be scrapped and replaced with a new filter assembly.
4. Begin cleaning with Challenger Re-charger Kit P/N CP-99-5050, the only FAA approved re-charge kit. Inside are two squeeze bottles, one for cleaning and one red in color for re-oiling the filter element. Remove the bottle containing cleaning fluid and thoroughly saturate the filter. Allow the filter to soak for approximately 15 minutes. DO NOT USE ANY OTHER CLEANING FLUID.
5. Flush the filter with low non-pressurized warm water starting from inside out. After flush, gently shake the water out of the filter and allow to air dry only. DO NOT USE ANY OTHER DRYING METHOD.
6. Remove the bottle from the Re-charger Kit P/N CP-99-5050 containing oil red in color. Begin re-oiling the dry filter by applying a bead or line of red oil along the top only of each pleat of the filter. The oil will soak into the length of each pleat. It may be necessary to apply oil on filter material that has not received oil from the wicking action. The entire filter medium must be covered with red oil. DO NOT OVER OIL. If oil drips from the filter, it has been over oiled. Allow the filter to drain the excess oil onto a clean rag or paper towel until the red oil stops dripping. Replace gasket with a new one on the frame surface to be mounted to the air box assembly.
7. Re-install air filter. Make sure the air filter assembly is properly seated and is mounted securely to the filter air box assembly.
8. Re-install engine cowling.

-NOTE-

Do not use gasoline, jet fuel, or caustic cleaning solutions or shop solvents. Use only FAA approved Challenger cleaning solution in Challenger Re-charger Kit P/N CP-99-5050.

Do not use steam cleaning equipment or any other cleaning devices. When drying the filter after cleaning, let the filter dry naturally. Pressurized equipment will strip the cotton of critical microfilaments.

Do not use compressed air, open flames or heating devices of any kind. When recharging the filter with oil, use only FAA approved Challenger Re-charger Oil in Re-charger Kit P/N CP-99-5050. The oil is the same oil applied at the factory during the manufacturing process.

Do not use transmission fluid, motor oil, or any other lightweight oil of any kind or any products containing petroleum products.

Dry-Type Air Filters

The dry-type filter can usually be washed six to eight times before replacement is necessary. Replace the paper induction air filter every 500 HOURS or at ONE YEAR intervals, whichever occurs first.



To clean the dry-type induction air filter:

1. Remove engine cowling.
2. Remove filter element.
3. Direct a jet of air from inside of filter out (opposite normal airflow). Cover entire filter area with air jet.

-CAUTION-

Do not use a compressor unit with a nozzle pressure greater than 100 PSI.

4. After cleaning, inspect filter for damage. Discard if filter or gasket is damaged.

-NOTE-

If filter shows an accumulation of carbon, soot, or oil, continue with cleaning steps "5" through "8."

5. Soak filter in non-sudsing detergent for 15 minutes; then agitate filter back and forth for two to five minutes to free filter element of deposits.

-NOTE-

A Donaldson D-1400 Filter Cleaner is also recommended. Do not use solvents.

6. Rinse filter element with a stream of clear water until rinse water is clear.
7. Dry filter thoroughly. Do not use a light bulb or air heated above 180° F. for filter drying.
8. Inspect for damage and ruptures by holding light bulb inside filter. If damage is evident, replace filter with a new one.

GEAR & TIRES

The aircraft is equipped with 6-ply, Type III, standard-brand tires and tubes. Keep main gear tires inflated at 42 PSI and the nose tire at 49 PSI for maximum service life. Proper inflation will minimize tire wear and impact damage. Visually inspect tires during pre-flight for cracks, ruptures and worn spots. Avoid taxi speeds that require heavy braking or fast turns. Keep the gear and exposed gear retraction system components free of mud and ice to prevent retraction interference and binding. It is recommended that retraction/extension cycles (5 minimum) be done any time any tire is replaced to assure that no interference exists during the cycle.

-CAUTION-

After any landing, other than a smooth touchdown and rollout, when aircraft is above 3200 Lbs (1,452 Kg), the aircraft should undergo the Gear System Operational Inspection as outlined in M20V Service and Maintenance Manual, Chapter 32.

The gear warning VOICE ALERT may be checked in flight by retarding throttle with the gear up. The gear warning VOICE ALERT should sound when throttle is positioned 1/4 to 3/8 inch from idle (while gear is up).

BATTERIES

The two 24-volt, 10 ampere-hour electrical sealed storage batteries are located in the tailcone, aft of baggage compartment bulkhead, accessible through left and right side tailcone access panels.

To service batteries, remove tailcone access cover(s) to gain access to battery(ies). Check terminals and connectors for corrosion.

Keep battery at full charge to prevent freezing in cold weather and to prolong service life.



-CAUTION-

Alternator and voltage regulator operate only as a one-polarity system. Be sure the polarity is correct when connecting a charger or booster battery.

If corrosion is present, flush battery, shelf and mounting area with a solution of baking soda and water. Keep cable connections clean and tightly fastened.

HYDRAULIC BRAKE RESERVOIR SYSTEM

The brake system hydraulic reservoir is located on the tailcone bulkhead, forward of the avionics components. To service, remove the left side tailcone access panel and check fluid level every 50 HOURS of operation. Fluid level should be no higher than two (2) inches (5 cm) below filler cap. Use only hydraulic fluid (Red) conforming to specification MIL-H-5606. DO NOT FILL reservoir while parking brake is set.

OXYGEN SYSTEM: (see Supplemental Information in [Section IX](#))

MAINTENANCE

ENGINE PERFORMANCE CHECKS

When the aircraft leaves the factory the TSIO-550-G() engine has been properly tuned and will perform at optimum efficiency. To insure that the engine is continuing to perform properly certain maintenance action should be performed during the 100 HOUR or ANNUAL inspection or whenever it is suspected that engine performance is not correct.

Refer to M20V SERVICE AND MAINTENANCE MANUAL or Continental Motors, Inc. maintenance manuals for specific maintenance actions to adjust engine, if necessary.

PROPELLER CARE

The high stresses to which propeller blades are subjected makes their careful inspection and maintenance vitally important. Check blades for nicks, cracks or indications of other damage before each flight. Nicks tend to cause high stress concentrations in the blades which, if ignored, may result in cracks. It is very important that all nicks and scratches be repaired prior to flight. It is not unusual for propeller blades to have some end play or fore and aft movement as a result of manufacturing tolerances in the parts. This has no adverse effect on propeller performance or operation. With the first turn, centrifugal force firmly seats the blades, rigidly and positively against the retention bearing in the propeller hub. Routine propeller servicing is described in the latest revision of Hartzell Manual 115N (Propeller Owner's Manual).

Pre-flight inspection of the propeller blades should include, in addition to the foregoing, an occasional wiping with a cloth soaked in kerosene. NEVER USE AN ALKALINE CLEANER ON THE BLADES.

Your Mooney Service Center will answer any questions you may have concerning blade repair and inspection.

EXTERIOR CARE

As with any paint applied to a metal surface, an initial curing period is necessary for developing the desired qualities of durability and appearance. Therefore, DO NOT APPLY WAX TO THE NEW AIRCRAFT EXTERIOR UNTIL TWO OR THREE MONTHS AFTER DELIVERY. Wax substances will seal paint from the air and prevent curing. Wash the exterior to prevent dirt from working into the curing paint. Hold buffing to a minimum until curing is complete and there is no danger of disturbing the undercoat.

-CAUTION-

Before washing the exterior, be certain the brake discs are covered, a pitot cover is in place, and all static-air buttons are masked off.

Remove grease or oil from the exterior by wiping with a cotton cloth saturated in kerosene. Flush away loose dirt and mud deposits before washing the exterior with an aircraft-type washing compound mixed in warm water. Use soft cleaning cloths or a chamois, and USE ONLY MILD LIQUID TYPE DETERGENTS, avoid harsh or abrasive detergents that might scratch or corrode the surface. It is essential that ALL CLEANING COMPOUNDS AND APPLICATION CLOTHS



BE FREE OF ABRASIVES, GRIT, OR OTHER FOREIGN MATTER. Use a pre-wax cleaner to remove a heavy oxidation film. For non-oxidized or pre-cleaned surfaces, apply a good exterior finish wax recommended for protection of urethane enamel finishes. Carefully follow the manufacturer's instructions. A heavier coating of wax on the leading edge of the wings, empennage, and nose section will help reduce drag and abrasion in these areas.

If fuel, hydraulic fluid or any other dye-containing substance is found on the exterior paint, wash the area at once to prevent staining.

Before wiping windows or windshield, flush exterior with clear water to remove particles of dirt. Household window cleaning compounds should NOT be used; some contain abrasives or solvents which could harm Plexiglass. Any commercial anti-static Plexiglass cleaner is recommended for cleaning and polishing the windshield and windows.

INTERIOR CARE

Normal household cleaning practices are recommended for routine interior care. Frequently vacuum clean seats, carpets, fabric, side panels and headliner to remove as much surface dust and dirt as possible. Spot clean Neather Leather with mild soap and water. For stubborn stains, use mild solvent such as Fantastik® or 409®. Other type cleaners are not recommended at this time.

-CAUTION-

Never use benzene, carbon tetrachloride, acetone, or gasoline for cleaning Plexiglass or interior panels. Carefully follow the manufacturer's instructions when using commercial cleaning and finishing compounds.

Foam type shampoos may be used for routine cleaning of carpets. To minimize carpet wetting, keep foam type cleaners as dry as possible and gently rub in circles. Use vacuum cleaner to remove foam and dry the materials. Grease spots, on carpet, should be removed with jelly-type spot lifter. Do not saturate carpet with a solution which could damage backing materials.

Use a damp cloth to clean metal surfaces.

AIRPLANE FILE

Certain miscellaneous data, information and licenses are a part of the airplane file. The following is a checklist of documents that must either be carried in the airplane or available on request of the proper authority.

1. To be displayed in the airplane at all times:
 - a.) Aircraft Airworthiness Certificate (FAA Form 8100-2).
 - b.) Aircraft Registration Certificate (FAA Form 8050-3).
2. To be carried in the airplane during all flight operations:
 - a.) Pilot's Operating Handbook (including FAA Approved Flight Manual).
 - b.) Weight and Balance, and associated papers (latest copy of the Repair and Alteration Form, FAA Form 337, if applicable).
 - c.) Equipment List.

-NOTE-

The original weight and balance data and Equipment List are contained in [SECTION VI](#) of this manual. This manual is supplied with each new airplane purchased from Mooney International Corporation. It is recommended that copies of [SECTION VI](#) be made and stored in a safe place.

3. To be made available upon request:
 - a.) Airplane Log Book.
 - b.) Engine Log Book.

Since the regulations of other nations may require other documents and data, owners of airplanes not registered in the United States should check with their own aviation officials to determine their individual requirements.



INTRODUCTION

FAA approved data pertaining to Limitations, Normal Procedures, Emergency Procedures and effects on performance for certain optional equipment installed in the airplane are contained in this section. Commonly installed items of optional equipment whose function and operation do not require detailed instructions are described by [Section VII](#).

The supplements are Approved by the FAA prior to incorporation into the Airplane Flight Manual.



BLANK



TABLE OF CONTENTS

TITLE	SECTION
INTRODUCTION	10-3
GENERAL	10-4
GENERAL SOURCES OF INFORMATION	10-5
RULES AND REGULATIONS	10-5
FAR, PART 39, AIRWORTHINESS DIRECTIVES	10-5
AIRMAN INFORMATION, ADVISORIES, AND NOTICES, FAA AERONAUTICAL INFORMATION MANUAL	10-5
ADVISORY INFORMATION	10-6
GENERAL INFORMATION ON SPECIFIC TOPICS	10-6
FLIGHT PLANNING	10-6
INSPECTIONS-MAINTENANCE	10-6
SPECIAL CONDITIONS CAUTIONARY NOTICE	10-6
WALK AROUND INSPECTIONS	10-7
COCKPIT CHECKS	10-7
FLIGHT OPERATIONS	10-7
GENERAL	10-7
TURBULENT WEATHER	10-7
FLIGHT IN TURBULENT AIR	10-8
MOUNTAIN FLYING	10-8
VFR-LOW CEILINGS	10-8
VFR AT NIGHT	10-8
VERTIGO-DISORIENTATION	10-9
STALLS, SPINS AND SLOW FLIGHT	10-9
STANDARD PROCEDURE - SPIN RECOVERY	10-10
VORTICES-WAKE TURBULENCE	10-10
TAKE-OFF AND LANDING CONDITIONS	10-10
MEDICAL FACTS FOR PILOTS	10-11
GENERAL	10-11
FATIGUE	10-11
HYPOXIA	10-11
HYPERVENTILATION	10-11
ALCOHOL	10-11
DRUGS	10-12
SCUBA DIVING	10-12
ADDITIONAL INFORMATION	10-12
MANUFACTURER'S INFORMATION	10-12



BLANK



INTRODUCTION

The best of engineering know-how and manufacturing craftsmanship have gone into the design and building of your Mooney aircraft. Like any high performance airplane, it operates most efficiently and safely in the hands of a skilled pilot.

We urge you to be thoroughly familiar with the contents of your operating manuals, placards, and check list to insure maximum utilization of your airplane. When the airplane has changed ownership, some of these may have been misplaced. If any are missing, replacements should be obtained from any Authorized Mooney Service Center as soon as possible.

For your added protection and safety, we have added this special section to the Pilot's Operating Handbook to refresh your knowledge of a number of safety subjects. You should review these subjects periodically.

Topics in this section are mostly excerpts from FAA Documents and other articles pertaining to the subject of safe flying. They are not limited to any particular make or model airplane and do not replace instructions for particular types of airplanes.

Your Mooney aircraft was designed and built to provide you with many years of safe and efficient transportation. By maintaining it properly and flying it prudently, you should realize its full potential.



GENERAL

Flying is one of the safest modes of travel. Remarkable safety records are being established each year. As a pilot you are responsible to yourself, your relatives, to those who travel with you, to other pilots and to ground personnel to fly wisely and safely.

The following materials in this Safety section covers several subjects in limited detail. Here are some condensed DO's and Don't.

DO'S

1. Be thoroughly familiar with your airplane and be current in it, or get a check ride.
2. Pre-plan all aspects of your flight - including weather.
- FLY YOUR PLAN -
3. Use services available - FSS, Weather Bureau, etc.
4. Pre-flight you airplane thoroughly.
5. Use your checklists.
6. Have more than enough fuel for take off, the planned trip, and adequate reserve.
7. Be sure your weight loading and C.G. are within limits.
8. Be sure articles and baggage are secured.
9. Check freedom of all controls.
10. Maintain appropriate airspeed in take off, climb, descent and landing.
11. Avoid other aircraft wake turbulence.
12. Switch fuel tanks before engine starvation occurs.
13. Practice engine out, emergency landing gear extension and other emergency procedures at safe altitude; preferably with a check pilot.
14. Use caution in mountainous terrain.
15. Keep your airplane in good mechanical condition.
16. Stay informed and alert, fly in a sensible manner.

DON'TS

1. Don't take off with frost, ice or snow on the aircraft surfaces.
2. Don't take off with less than minimum recommended fuel, plus reserves.
3. Don't fly in a reckless, show off, careless manner.
4. Don't fly in thunderstorms or severe weather.
5. Don't fly in possible icing conditions. If you encounter icing conditions, alter altitude or course to minimize exposure.
6. Don't apply controls abruptly or with high forces that could exceed design loads of the airplane.
7. Don't fly when physically or mentally exhausted.
8. DON'T TRUST LUCK.



GENERAL SOURCES OF INFORMATION

There is a wealth of information available to the pilot created for the sole purpose of making your flying easier, faster, and safer. Take advantage of this knowledge and be prepared for an emergency in the remote event that one should occur. You as a pilot also have certain responsibilities under government regulations. These are designed for your own protection. Compliance is not only beneficial but mandatory.

RULES AND REGULATIONS

Federal Aviation Regulations, Part 91, General Operating and Flight Rules, is a document of law governing operation of aircraft and the owner's and pilot's responsibilities.

This document covers such subjects as:

- Responsibilities and authority of the pilot in command
- Certificates required
- Liquor and drugs
- Flight plans
- Pre-flight action
- Fuel requirements
- Flight rules
- Maintenance, preventative maintenance, alterations, inspections and maintenance records

These are only some of the topics covered. It is the owner's and pilot's responsibility to be thoroughly familiar with all items in FAR Part 91 and to follow them.

FEDERAL AVIATION REGULATIONS, PART 39 - AIRWORTHINESS DIRECTIVES

This document specifies that no person may operate a product to which an airworthiness directive issued by the FAA applies, except in accordance with the requirements of that airworthiness directive.

AIRMAN INFORMATION, ADVISORIES, AND NOTICES, FAA AERONAUTICAL INFORMATION MANUAL

This document contains a wealth of pilot information for nearly all realms of flight, navigation, ground procedures and medical information. Among the subjects are:

- Controlled Air Space
- Services Available to Pilots
- Radio Phraseology and Technique
- Airport Operations
- Clearances and Separations
- Pre-flight
- Departures - IFR
- Enroute - IFR
- Arrival - IFR
- Emergency Procedures
- Weather
- Wake Turbulence
- Medical Facts for Pilots
- Bird Hazards
- Good Operating Practices
- Airport Location Directory



We urge all pilots to be thoroughly familiar with and use the information in this manual.

ADVISORY INFORMATION

Airmen can subscribe to services to obtain FAA NOTAMS and Airman Advisories, and these are also available at FAA Flight Service Stations. NOTAMS are documents that have information of a time-critical nature that would affect a pilot's decision to make a flight; for example, an airport closed, terminal radar out of service, enroute navigational aids out of service, etc.

GENERAL INFORMATION ON SPECIFIC TOPICS

FLIGHT PLANNING

FAR Part 91 requires that each pilot in command, before beginning a flight, familiarize himself with all available information concerning that flight.

All pilots are urged to obtain a complete preflight briefing. This would consist of weather; local, enroute and destination, plus alternates, enroute navaid information. Also airport runways active, length of runways, takeoff and landing distances for the airplane for conditions expected should be known.

The prudent pilot will review his planned enroute track and stations and make a list for quick reference. It is strongly recommended a flight plan be filed with Flight Service Stations even though the flight may be VFR. Also, advise Flight Service Stations of changes or delays of one hour or more and remember to close the flight plan at destination.

The pilot must be completely familiar with the performance of the airplane and performance data in the airplane manuals and placards. The resultant effect of temperature and pressure altitude must be taken into account in determining performance if not accounted for on the charts. Applicable FAA manuals must be aboard the airplane at all times including the weight and balance forms and equipment lists.

The airplane must be loaded so as not to exceed the weight and the weight and balance loading center of gravity (c.g.) limitations. Also, that at least minimum fuel for takeoff is aboard and sufficient for the trip, plus reserves. Oil in the engines should be checked and filled as required.

INSPECTIONS - MAINTENANCE

In addition to maintenance inspections and preflight information required by CFR Part 43 and 91, a complete pre-flight inspection is imperative. It is the responsibility of the owner and operator to assure that the airplane is maintained in an airworthy condition and proper maintenance records are kept.

While the following items can not substitute for the pre-flight specified for each type of airplane, they will serve as reminders of general items that should be checked.

SPECIAL CONDITIONS CAUTIONARY NOTICE

Airplanes operated for Air Taxi or other than normal operation and airplanes operated in humid tropics or cold and damp climates, etc., may need more frequent inspections for wear, corrosion and or lack of lubrication. In these areas periodic inspections should be performed until the operator can set his own inspection periods based on experience.

-NOTE-

The required periods do not constitute a guarantee that the item will reach the period without malfunction, as the aforementioned factors cannot be controlled by the manufacturer.

Corrosion, and its effects, must be treated at the earliest possible opportunity. A clean dry surface is virtually immune to corrosion. Make sure that all drain holes remain unobstructed. Protec-



tive films and sealants help to keep corrosive agents from contacting metallic surfaces. Corrosion inspections should be made most frequently under high-corrosion-risk operating conditions, such as in regions of heavy airborne salt concentrations (e.g., near the sea) and high-humidity areas (e.g., tropical regions).

WALK AROUND INSPECTIONS

All airplane surfaces free of ice, frost or snow.
Tires properly inflated.
All external locks, covers and tie downs removed.
Fuel sumps drained.
Fuel quantity, adequate for trip, plus reserve, (visually checked) and access doors secured.
Oil quantity checked and access doors secured.
Check general condition of airplane, engine, propeller, exhaust stacks, etc.
All external doors secured.

COCKPIT CHECKS

Flashlight available.
Required documents on board.
Use the check list.
All internal control locks removed (If installed).
Check freedom of controls.
Cabin and baggage doors properly closed.
Seat belts and shoulder harnesses fastened.
Passengers briefed.
Engine and propeller operating satisfactorily.
All engine gauges checked for proper readings.
Fuel selector in proper position.
Fuel quantity checked by gauges.
Altimeter setting checked.

FLIGHT OPERATIONS

GENERAL

The pilot should be thoroughly familiar with all information published by the manufacturer concerning the airplane. The pilot is required by FAA to operate in accordance with the FAR's and the FAA Approved Airplane Flight Manual and/or placards installed.

TURBULENT WEATHER

A complete weather briefing prior to beginning a flight is the start of assurance of a safe trip. Updating of weather information enroute is another assurance. However, the wise pilot also knows weather conditions change quickly at times and treats weather forecasting as professional advice rather than as absolute fact. He obtains all the advice he can, but still stays alert through knowledge of weather changes, observations, and conditions.

Plan the flight to avoid areas of severe turbulence and thunderstorms. It is not always possible to detect individual storm areas or find the in between clear areas.

Thunderstorms, squall lines and violent turbulence should be regarded as extremely dangerous and **MUST** be avoided. Hail and tornadic wind velocities can be encountered in thunderstorms that can destroy any airplane, just as tornados destroy nearly everything in their path on the ground.

A roll cloud ahead of a squall line or thunderstorm is visible evidence of violent turbulence, however, the absence of a roll cloud should not be interpreted as denoting the lack of turbulence.



FLIGHT IN TURBULENT AIR

Even though flight in severe turbulence is to be avoided, flight in turbulent air may be encountered under certain conditions. Flying through turbulent air presents two basic problems, to both of which the answer is PROPER AIRSPEED. On the one hand, if you maintain an excessive airspeed, you run the risk of structural damage or failure; on the other hand, if your airspeed is too low, you may stall. If turbulence encountered in cruise or descent becomes uncomfortable to the pilot or passengers, the best procedure is to reduce speed to the maneuvering speed, which is listed in the Limitations Section of the FAA Approved Airplane Flight Manual and Pilots Operating Handbook. This speed gives the best assurance of avoiding excessive stress loads, and at the same time providing margin against inadvertent stalls due to gusts.

Beware of overcontrolling in attempting to correct for changes in altitude; applying control pressure abruptly will build up G-forces rapidly and could cause damaging structural stress loads. You should watch particularly your angle of bank, making turns as wide and shallow as possible, and be equally cautious in applying forward or back pressure to keep the nose level. Maintain straight and level attitude in either up or down drafts. Use trim sparingly to avoid being grossly mistrimmed as the vertical air columns change velocity and direction.

MOUNTAIN FLYING

Avoid flight at low altitudes over mountainous terrain, particularly near the lee slopes.

- OBSERVE PUBLISHED MINIMUM ENROUTE ALTITUDES (MEA) -

If the wind velocity near the level of the ridge is in excess of 25 knots and approximately perpendicular to the ridge, mountain wave conditions are likely over and near the lee slopes. If the wind velocity at the level of the ridge exceeds 50 knots, a strong mountain wave is probable with strong up and down drafts and severe or extreme turbulence. The worst turbulence will be encountered in and below the rotor zone which is usually 8 to 10 miles down wind from the ridge. This zone is characterized by the presence of "roll clouds" if sufficient moisture is present; alto-cumulus standing lenticular clouds are also visible signs that a mountain wave exists, but their presence is likewise dependent on moisture. Mountain wave turbulence can, of course, occur in dry air and the absence of such clouds should not be taken as any assurance that mountain wave turbulence will not be encountered. A mountain wave down draft may exceed the climb capability of your airplane.

- AVOID MOUNTAIN WAVE DOWN DRAFTS -

VFR - LOW CEILINGS

If you are not instrument rated, avoid "VFR On Top" and "Special VFR". Being caught above an undercast when an emergency descent is required (or at destination) is an extremely hazardous position for the VFR pilot.

Accepting a clearance out of certain airport control zones with no minimum ceiling and one-mile visibility as permitted with "Special VFR" is not a recommended practice for VFR pilots.

Avoid areas of low ceilings and restricted visibility unless you are instrument proficient and have an instrument equipped airplane. Then proceed with caution and have planned alternates.

VFR - AT NIGHT

When flying VFR at night, in addition to the altitude appropriate for the direction of flight, pilots should maintain a safe minimum altitude as dictated by terrain, obstacles such as TV towers, or communities in the area flown. This is especially true in mountainous terrain, where there is usually very little ground reference and absolute minimum clearance is 2,000 feet. Don't depend on your being able to see obstacles in time to miss them. Flight on dark nights over sparsely populated country can be almost the same as IFR and should be avoided by untrained pilots.



VERTIGO - DISORIENTATION

Disorientation can occur in a variety of ways. During flight, inner ear balancing mechanisms are subjected to varied forces not normally experienced on the ground. This combined with loss of outside visual reference can cause vertigo. False interpretations (illusions) result and may confuse the pilot's conception of the attitude and position of his airplane.

Under VFR conditions the visual sense, using the horizon as a reference, can override the illusions. Under low visibility conditions (night, fog, clouds, haze, etc.) the illusions predominate. Only through awareness of these illusions, and proficiency in instrument flight procedures, can an airplane be operated safely in a low visibility environment.

Flying in fog, dense haze or dust, cloud banks, or very low visibility, with strobe lights, and particularly rotating beacons turned on frequently causes vertigo. They should be turned off in these conditions, particularly at night.

All pilots should check the weather and use good judgment in planning flights. The VFR pilot should use extra caution in avoiding low visibility conditions.

Motion sickness often precedes or accompanies disorientation and may further jeopardize the flight.

STALLS, SPINS AND SLOW FLIGHT

Stalls, and slow flight should be practiced at safe altitudes to allow for recovery. Any of these maneuvers should be performed at an altitude in excess of 6,000 feet above ground level. Spins may be dangerous and should be avoided. In fact, most airplanes are placarded against intentional spins. Spins are preceded by stalls. A prompt and decisive stall recovery protects against inadvertent spins. All airplanes are required to have flight characteristics that give adequate advance warning of an impending stall or they must be equipped with an artificial stall warning device. Keep the artificial system in good working order. Do not operate the airplane with the device made inoperative by the use of circuit breakers or other means.

Stalls should be practiced at safe altitudes for ample recovery. Should a spin be encountered inadvertently, spin recovery should be initiated immediately.

As stall attitude is approached, be alert. Take prompt corrective action to avoid the stall or if you are practicing stalls, react the moment the stall occurs. The following is suggested:

1. Do not carry passengers. Be certain that the airplane's center of gravity is as far forward as possible. Forward CG aids spin recovery.
2. Be certain that both student pilot and instructor pilot have a full set of operable controls.
3. Conduct such practice at altitudes in excess of 6,000 ft. above ground level.

Remember that an airplane at or near traffic pattern altitude probably will not recover from a spin before impact with the ground. When descending to traffic pattern altitude and during operation in the traffic pattern and approach, maintain a safe margin above stall speed. During takeoff or go-around, be especially careful to avoid departure stalls associated with turns at low speed. Maintain speeds recommended in this handbook (Section II & V).



STANDARD PROCEDURE FOR SPIN RECOVERY

In the event of an inadvertent spin, the following recovery procedure should be used:

- Throttle RETARD to IDLE
- Ailerons NEUTRAL
- Rudder Apply FULL RUDDER opposite the direction of spin.
- Control Wheel FORWARD of neutral in a brisk motion to break stall.
..... Additional FORWARD elevator control may be required if rotation does not stop.
- Flaps (If extended) RETRACT as soon as possible
- Rudder NEUTRALIZE when spin stops.
- Control Wheel Smoothly MOVE AFT to bring the nose up
..... to a level flight attitude after spin has stopped.

VORTICES - WAKE TURBULENCE

Every airplane generates wakes of turbulence while in flight. Part of this is from the propeller or jet engine and part from the wing tip vortices. The larger and heavier the airplane the more pronounced wake turbulence will be. Wing tip vortices from large heavy airplanes are very severe at close range, degenerating with time, wind and space. These are rolling in nature from each wing tip. In test, vortex velocities of 133 knots have been recorded. Exhaust velocities from large airplanes at takeoff have been measured at 25 MPH, 2100 feet behind medium, large airplanes.

Encountering the rolling effect of wing tip vortices within two minutes or less after passage of large airplanes is hazardous to light airplanes. This roll effect can exceed the maximum counter roll obtainable in an airplane.

The turbulent areas may remain for as long as three minutes or more, depending on wind conditions, and may extend several miles behind the airplane. Plan to fly slightly above or to the up wind side of the other airplane's flight path.

Because of the wide variety of conditions that can be encountered, there is no set rule to follow to avoid wake turbulence in all situations. However, the Aeronautical Information Manual goes into considerable detail for a number of wake turbulence avoidance procedures. Use prudent judgment and allow ample clearance time and space following or crossing the wake turbulence of other airplanes in all takeoff, climb out, approach and landing operations. Be observant of wake turbulence from all aircraft, regardless of size.

The Aeronautical Information Manual contains a section on wake turbulence. FAA Advisory Circular AC 90-23F is also recommended reading.

TAKE-OFF AND LANDING CONDITIONS

When taking off on runways covered with water or freezing slush, the landing gear should remain extended for approximately ten seconds longer than normal, allowing the wheels to spin and dissipate the freezing moisture. The landing gear should then be cycled up, then down, wait approximately five seconds and then retract again. Caution must be exercised to assure that the entire operation is performed below Maximum Landing Gear Operating Air speed.

Use caution when landing on runways that are covered by water or slush which cause hydroplaning (aquaplaning), a phenomenon that renders braking and steering ineffective because of the lack of sufficient surface friction. Snow and ice covered runways are also hazardous. The pilot should be alert to the possibility of the brakes freezing.

Use caution when taking off or landing in gusty winds. Be aware of special wind conditions caused by buildings or other obstructions located near runway in a crosswind pattern.



MEDICAL FACTS FOR PILOTS

GENERAL

Modern industry's record in providing reliable equipment is very good. When the pilot enters the airplane, he becomes an integral part of the man-machine system. He is just as essential to a successful flight as the control surfaces. To ignore the pilot in pre-flight planning would be as senseless as failing to inspect the integrity of the control surfaces or any other vital part of the machine. The pilot himself has the responsibility for determining his reliability prior to entering the airplane for flight. While piloting an airplane, an individual should be free of conditions which are harmful to alertness, ability to make correct decisions, and rapid reaction time.

FATIGUE

Fatigue generally slows reaction times and causes foolish errors due to inattention. In addition to the most common cause of fatigue, insufficient rest and loss of sleep, the pressure of business, financial worries and family problems, can be contributing factors. If your fatigue is a factor prior to a given flight, don't fly. To prevent fatigue effects during long flights, keep mentally active by making ground checks and radio-navigation position plots.

HYPOXIA

Hypoxia in simple terms is a lack of sufficient oxygen to keep the brain and other body tissues functioning properly. There is wide individual variation in susceptibility to hypoxia. In addition to progressively insufficient oxygen at higher altitudes, anything interfering with the blood's ability to carry oxygen can contribute to hypoxia (anemias, carbon monoxide, and certain drugs). Also, alcohol and various drugs decrease the brain's tolerance to hypoxia. Your body has no built in alarm system to let you know when you are not getting enough oxygen. It is impossible to predict when or where hypoxia will occur during a flight, or how it will manifest itself. A major early symptom of hypoxia is an increased sense of well-being (referred to as euphoria). This progresses to slow reactions, impaired thinking ability, unusual fatigue, and dull headache feeling.

Symptoms are slow but progressive, insidious in onset, and are most marked at altitudes starting above 10,000 feet. Night vision, however, can be impaired starting at altitudes lower than 10,000 feet. Heavy smokers may experience early symptoms of hypoxia at altitudes lower than non-smokers. Use oxygen on flights above 10,000 feet and at anytime when symptoms appear.

HYPERVENTILATION

Hyperventilation or over-breathing, is a disturbance of respiration that may occur in individuals as a result of emotional tension or anxiety. Under conditions of emotional stress, fright, or pain, breathing rate may increase, causing increased lung ventilation, although the carbon dioxide output of the body cells does not increase. As a result, carbon dioxide is "washed out" of the blood. The most common symptoms of hyperventilation are: dizziness; hot and cold sensations; tingling of the hands, legs and feet; tetany; nausea; sleepiness; and finally unconsciousness.

Should symptoms occur that cannot definitely be identified as either hypoxia or hyperventilation, try three or four deep breaths of oxygen. The symptoms should improve markedly if the condition was hypoxia (recovery from hypoxia is rapid). If the symptoms persist, discontinue use of oxygen; consciously slow your breathing rate until symptoms clear; then resume normal breathing rate. Normal breathing can be aided by talking aloud.

ALCOHOL

Common sense and scientific evidence dictate that you not fly as a crew member while under the influence of alcohol. Even small amounts of alcohol in the human system can adversely affect judgment and decision making abilities. FAR 91.11 states "(a) No person may act as a crew member - (1) within 8 hours after the consumption of any alcoholic beverage."

Tests indicate that as a general rule, 2 ounces (.06 liters) of alcohol at 15,000 feet produce the same adverse effects as 6 ounces (.18 liters) at sea level. In other words, the higher you get, "the higher you get."



DRUGS

Self-medication or taking medicine in any form when you are flying can be extremely hazardous. Even simple home or over-the-counter remedies drugs such as aspirin, antihistamines, cold tablets, cough mixtures, laxatives, tranquilizers, and appetite suppressors, may seriously impair the judgment and coordination needed while flying. The safest rule is to TAKE NO MEDICINE before or while flying, except on the advice of your Aviation Medical Examiner.

SCUBA DIVING

Flying shortly after any prolonged scuba diving could be dangerous. Under the increased pressure of the water, excess nitrogen is absorbed into your system. If sufficient time has not elapsed prior to take off for your system to rid itself of this excess gas, you may experience the bends at altitudes even under 10,000 feet, where most light planes fly.

ADDITIONAL INFORMATION

In addition to the coverage of subjects in this section, the National Transportation Safety Board and the FAA periodically issue general aviation pamphlets concerning aviation safety, and in greater detail. These can be obtained at FAA Offices, Weather Stations, Flight Service Stations, or Airport Facilities. These are very good sources of information and are highly recommended for study. Some of these are titled:

Aeronautical Information Manual
12 Golden Rules for Pilots
Weather or Not
Disorientation
Plane Sense
Weather Info Guide for Pilots
Wake Turbulence
Don't Trust Luck, Trust Safety
Thunderstorm - TRW
IFR- VFR , Either Way **Disorientation Can be Fatal**

MANUFACTURER'S INFORMATION

See following applicable pages of information that may have been inserted.

